

**Collection
2023/24**



STILNOVO

Lighting fixtures.

Appareils d'éclairage.

Productos para la iluminación.

Post-World War II Italy established itself internationally thanks to the happy combination of industrial design and the most famous names in architecture. Stilnovo was one of the first companies to transfer this combination to the lighting sector: since its foundation in 1946, it has never ceased to fascinate historians, collectors and design lovers.

L'Italie de l'après-guerre s'est imposée à l'international grâce à l'heureuse alliance du design industriel et des plus grands noms de l'architecture. Stilnovo a été l'une des premières entreprises à transférer cette combinaison au secteur de l'éclairage : depuis sa fondation en 1946, elle n'a jamais cessé de fasciner les historiens, les collectionneurs et les amateurs de design.

La Italia posterior a la Segunda Guerra Mundial se estableció internacionalmente gracias a la feliz combinación del diseño industrial y los nombres más famosos de la arquitectura. Stilnovo fue una de las primeras empresas en trasladar esta combinación al sector de la iluminación: desde su fundación en 1946, nunca ha dejado de fascinar a historiadores, coleccionistas y amantes del diseño.

Stilnovo today.

Stilnovo aujourd'hui.

Stilnovo hoy.

Today Stilnovo is part of Linea Light Group, world leader in LED lighting, from which it has inherited a collection of light and contemporary lamps, presented in this catalog together with some re-editions of magnificent icons of the past, designed by the Masters of 20th century design.

Aujourd'hui Stilnovo fait partie du groupe Linea Light, leader mondial de l'éclairage LED, dont il a hérité une collection de lampes lumineuses et contemporaines, présentées dans ce catalogue avec quelques rééditions de magnifiques icônes du passé, conçues par les maîtres de Conception du 20e siècle.

Hoy Stilnovo forma parte de Linea Light Group, líder mundial en iluminación LED, de la que ha heredado una colección de lámparas ligeras y contemporáneas, presentadas en este catálogo junto con algunas reediciones de magníficos iconos del pasado, diseñados por los Maestros de Diseño del siglo XX.

The collection.

La collection.

La colección.

Family Famille Familia	TABLE TABLE MESA	FLOOR SOL TIERRA	SUSPENSION SUSPENSION SUSPENSIÓN	WALL/CEILING MUR/PLAFOND PARED/TECHO
Bascula			146	
Bugia	16			266
Buonanotte	20			
Campana			152	
Demí			158	272
Demí Moon		94		
Diphy		98	164	276
Dynamic				280
Fante	24			284
Galassia		104	170	288
Goletta				294
Gravita	28			
Gravitino 541	36			298
Halley	40			
Honey			178	302
Inbilico				306
Kimia		108		
La Mariée	46		182	
Lama	50			312
Lampiatta	54		186	316
Luna		112	190	
Megafono	58		194	320
Meta	62			
Minibox	66			324
Minitopo	70			
Mongolfier			200	
Mr. Magoo		116	204	328
Opti-Line			208	
Oxygen		120	212	332
Periscopio	76	126		
Quad			218	338
Reflexio			224	342
Saliscendi			228	
Saturn			236	348
Sputnik			240	
Tablet		130	246	352
Topo	80	134		
Trepìù			250	
Triedro		138	256	356
Valigia	86			
Xilema			260	360
Xilema system				364
1Night/2Nights				370

Table
Table
Mesa



Bugia, p. 16



Buonanotte, p. 20



Fante, p. 24



Gravita, p. 28



Gravitino 541, p. 36



Halley, p. 40



La Mariée, p. 46

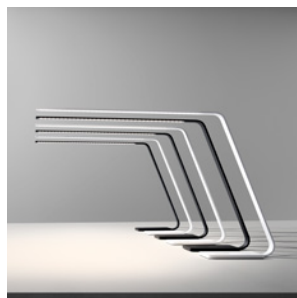

Lama, p. 50

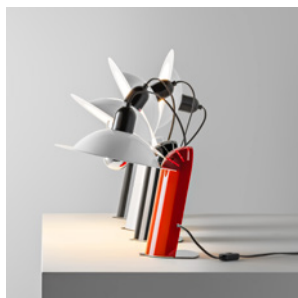

Lampiatto, p. 54



Megafono, p. 58



Meta, p. 62



Minibox, p. 66



Minitopo, p. 70



Periscopio, p. 76



Topo, p. 80

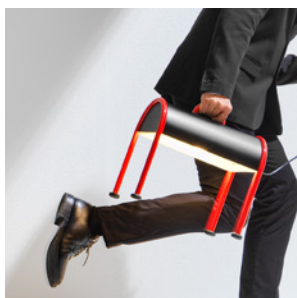

Valigia, p. 86

Floor
Sol
Tierra



Demí Moon, p. 94



Diphy, p. 98



Galassia, p. 104



Kimia, p. 108



Luna, p. 112



Mr Magoo, p. 116



Oxygen, p. 120



Periscopio, p. 126



Tablet, p. 130



Topo, p. 134



Triedro, p. 138

Suspension
Suspension
Suspensión



Bascula, p. 146



Campana, p. 152



Demí, p. 158



Diphy, p. 164



Galassia, p. 170

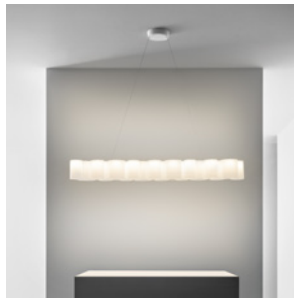

Honey, p. 178



La Mariée, p. 182



Lampiatto, p. 186

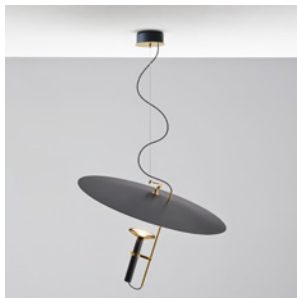

Luna, p. 190



Megafono, p. 194



Mongolfier, p. 200



Mr Magoo, p. 204



Opti-line, p. 208



Oxygen, p. 212



Quad, p. 218



Reflexio, p. 224

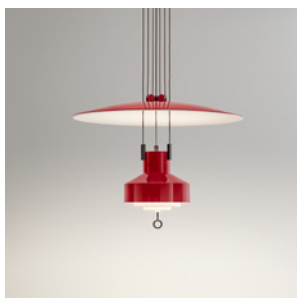

Saliscendi, p. 228



Saturn, p. 236

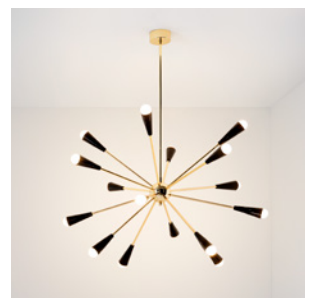

Sputnik, p. 240



Tablet, p. 246

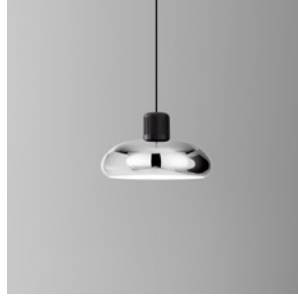

Trepìù, p. 250



Triedro, p. 256



Xilema, p. 260

Wall/ceiling
Mur/plafond
Pared/techo



Bugia, p. 266



Demí, p. 272

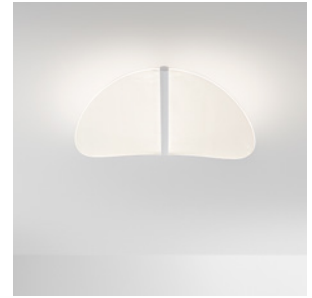

Diphy, p. 276

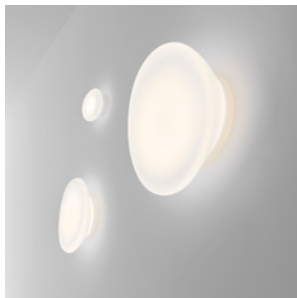

Dynamic, p. 280



Fante, p. 284

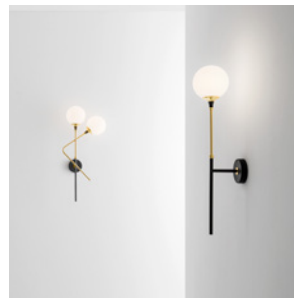

Galassia, p. 288



Goletta, p. 294



Gravitino 541, p. 298



Honey, p. 302



Inbilico, p. 306



Lama, p. 312



Lampiatto, p. 316

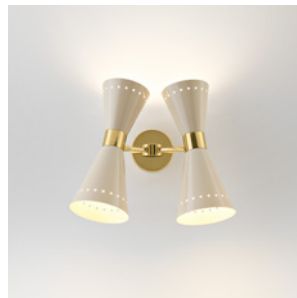

Megafono, p. 320

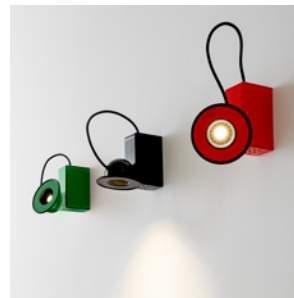

Minibox, p. 324



Mr Magoo, p. 328



Oxygen, p. 332



Quad, p. 338



Reflexio, p. 342



Saturn, p. 348



Tablet, p. 352



Triedro, p. 356

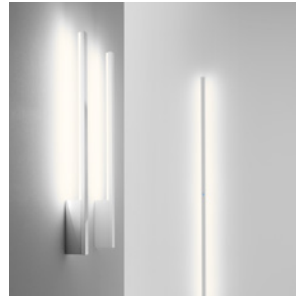

Xilema, p. 360



Xilema system, p. 364

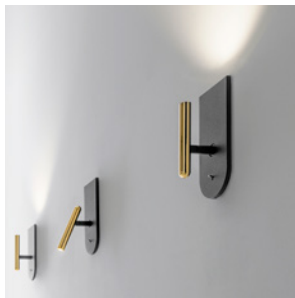

1Night/2Nights, p. 370

Table

Table
Mesa

Floor
Sol
Tierra

68

Suspension
Suspension
Suspensión

144

Wall/ceiling
Mur/plafond
Pared/techo

264



Bugia	16
Buonanotte	20
Fante	24
Gravita	28
Gravitino 541	36
Halley	40
La Mariée	46
Lama	50
Lampiatto	54
Megafono	58
Meta	62
Minibox	66
Minitopo	70
Periscopio	76
Topo	80
Valigia	86

Bugia

1977

Roberto Beretta
Antonio Macchi Cassia

The shape of these lamps recalls and celebrates the old-fashioned candle holder with handle, commonly called bugia in Italian, the simplified name of the African city Bidgiaya which supplied most of the wax used to make candles! Today this curious anecdote also accompanies our modern-day Bugia: a table or wall lamp in single or double versions, as simple as it is ingenious.

• **Structure in glossy painted metal, satin glass diffuser. Finishes: white, black, red, green, yellow. Black lampholder and cable.**

La forme de ces lampes rappelle les anciens bougeoirs à manche, communément appelés « bugia » en italien, nom simplifié de la ville africaine Bidgiaya qui fournissait la majeure partie de la cire utilisée pour fabriquer les bougies ! Cette anecdote accompagne aujourd'hui également la Bugia « moderne » : une lampe de table ou murale à simple ou double lumière, aussi simple qu'ingénieuse.

• **Structure en métal peint poli, diffuseur en verre satiné. Ampoules fournies. Finitions : blanc, noir, rouge, vert, jaune. Support de lampe et câble noirs.**

La forma de estas lámparas recuerda a los antiguos candelabros con mango, comúnmente llamados en italiano "bugia", nombre simplificado de la ciudad norteafricana de Bidgiaya, que suministraba la mayor parte de la cera utilizada para fabricar velas. Esta anécdota sigue acompañando hoy a la "moderna" Bugia: lámpara de mesa o de pared de luz simple o doble, tan sencilla como genial.

• **Estructura de metal pintado brillante, difusor de vidrio satinado. Bombillas incluidas. Acabados: blanco, negro, rojo, verde, amarillo. Portalámparas y cable en negro.**







TABLE **BUGIA**

STILNOVO 2023/24

1. Bugia



Included bulb
Sfera Full Light
LED Bulb E27 4,5W

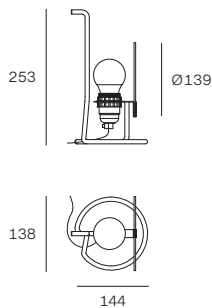

MOD	CODE	FINISH	SOURCE	INPUT	DIMMING	CCT (K)	LUMEN	CRI	IP	OPTICS
1	9680	WH	1xE27 4,5W	220-240V	No	2700	470	≥80	20	Diffused
	9681	BB	1xE27 4,5W	220-240V	No	2700	470	≥80	20	Diffused
	9682	GR	1xE27 4,5W	220-240V	No	2700	470	≥80	20	Diffused
	9683	RR	1xE27 4,5W	220-240V	No	2700	470	≥80	20	Diffused
	9684	YY	1xE27 4,5W	220-240V	No	2700	470	≥80	20	Diffused

Other versions: wall/ceiling, p. 266.

Buonanotte

1965

Giovanni Luigi Gorgoni

Buonanotte is a fun lamp that can be adjusted by rotating two metal shades that control the light beam simply by turning the spherical diffuser any way you please. With a simple gesture, the atmosphere changes: open for reading or closed and dimmed for sweet dreams.

• **Metal body painted in white, yellow, red, blue finishes. Triplex glass diffuser.**

Buonanotte est une lampe amusante qui peut être réglée en faisant tourner deux quarts métalliques qui, déplacés librement sur le diffuseur sphérique, contrôlent le faisceau lumineux. D'un simple geste, il change l'atmosphère : ouverte pour une bonne lecture ou fermée et diffuse, complice des rêves.

• **Corps en métal, diffuseur en verre soufflé triplex. Finitions : blanc, bleu, jaune, rouge. Verre blanc brillant.**

Buonanotte es una divertida lámpara que se puede ajustar girando dos cuartetas metálicas que, al moverse libremente sobre el difusor esférico, controlan el haz de luz.

Con un simple gesto, todo el ambiente cambia: abierta para una cómoda lectura o cerrada y atenuada, cómplice de sueños.

• **Cuerpo de metal, difusor en vidrio soplado triplex. Acabados: blanco, azul, amarillo, rojo. Vidrio blanco brillante.**

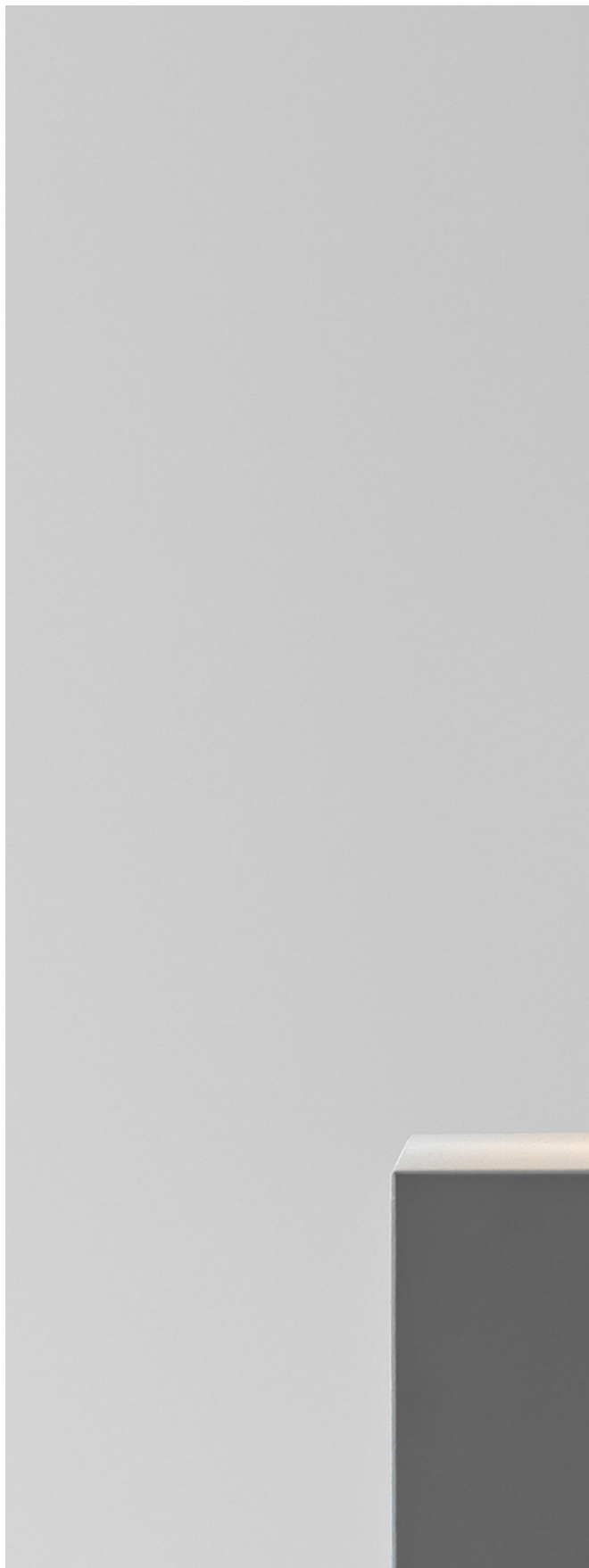





1. Buonanotte



Included bulb
 Classic P Retrofit
 LED Bulb E14 5W

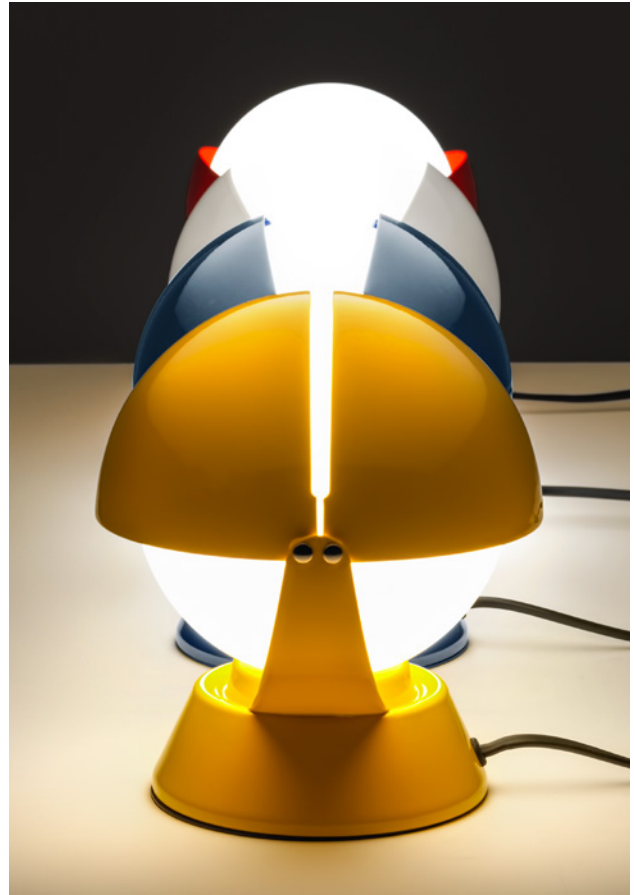
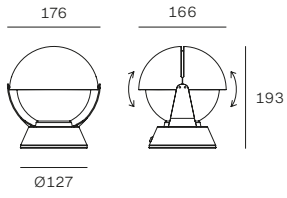

MOD	CODE	FINISH	SOURCE	INPUT	DIMMING	CCT (K)	LUMEN	CRI	IP	OPTICS
1	8961	WH	1xE14 5W	220-240V	No	2700	470	≥80	20	Diffused
	8962	RR	1xE14 5W	220-240V	No	2700	470	≥80	20	Diffused
	8963	YY	1xE14 5W	220-240V	No	2700	470	≥80	20	Diffused
	8964	BL	1xE14 5W	220-240V	No	2700	470	≥80	20	Diffused

Fante

1978

Jonathan De Pas
Donato D'Urbino
Paolo Lomazzi

Fante's light is easy to direct, thanks to the reflector on the head of the lamp that, like a wide-brimmed hat, defines the silhouette of an elegant, female figure. The freedom of inclination allows simultaneous control of both the illumination on the tabletop and the indirect diffused light for upward radiance. The conical base is soft and pleasing to the touch, perfectly completing the proportioned design.

• **Conical rubber base in black or brick-red colours.**
Adjustable disc in white painted aluminium.

La lumière de Fante est facile à orienter, grâce au réflecteur réglable sur l'ampoule elle-même. La liberté d'inclinaison permet de contrôler en même temps la lumière vers le bas et la lumière diffusée indirectement vers le haut. La base conique, douce et agréable au toucher, complète son design parfaitement proportionné.

• **Base en caoutchouc, parabole en aluminium.**
Finitions : rouge brique/blanc, noir/blanc.

La luz de Fante se orienta con facilidad, gracias al reflector ajustable en la propia bombilla. La libertad de inclinación permite controlar al mismo tiempo tanto la luz descendente como la luz indirecta difusa hacia arriba. La base cónica, suave y agradable al tacto, completa un diseño perfectamente proporcionado.

• **Base de goma, parábola en aluminio. Acabados: rojo ladrillo/blanco, negro/blanco.**







1. Fante



Included bulb
 Globo 125 Full Light
 LED Bulb E27 11W

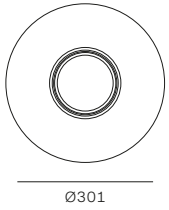
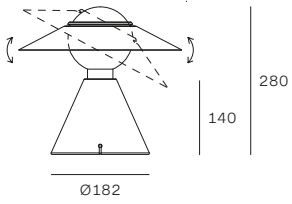

MOD	CODE	FINISH	SOURCE	INPUT	DIMMING	CCT (K)	LUMEN	CRI	IP	OPTICS
1	8966	BB WH	1xE27 11W	220-240V	No	2700	1520	≥80	20	Diffused
	8968	RR WH	1xE27 11W	220-240V	No	2700	1520	≥80	20	Diffused

Other versions: wall/ceiling, p. 284.

Gravita

1969

Antonio Macchi Cassia

A company history extending over fifty years of hard work. The dimmable light within a large glass sphere softly illuminates the environment. A smaller metal sphere orbits around the surface thanks to the magnetic solution of great ingenuity, projecting a concentrated and dimmable light. When it was conceived in 1969, this light was at the forefront of the canons and processes of the time and remains so even by modern standards. Gravita, an iconic lamp that illustrates the meaning of design.

• **Blown glass diffuser, directable sphere in aluminium, base in extruded aluminium. Finishes: clear/chrome/anodised black.**

Plus de cinquante ans de travail acharné et d'histoire d'entreprise. La lumière tamisable de la grande sphère en verre éclaire doucement la pièce. La petite sphère métallique tourne autour de la surface grâce à une ingénieuse solution magnétique, projetant une lumière concentrée et dimmable. Un concept avant-gardiste de 1969 par rapport aux canons et à la fabrication de l'époque et même pour les contemporains. Gravita, une lampe emblématique pour expliquer le sens du design.

• **Diffuseur en verre soufflé, sphère en aluminium réglable, base en aluminium extrudé. Finitions : transparent/chromé/anodisé noir.**

Más de cincuenta años de arduo trabajo e historia empresarial. La luz de intensidad regulable en la gran esfera de cristal ilumina suavemente el espacio. La esfera de metal, más pequeña, orbita sobre la superficie gracias a una solución magnética muy ingeniosa, proyectando una luz concentrada y dimmable. Diseño de 1969 a la vanguardia respecto de los cánones y procesos de la época, e incluso para los contemporáneos. Gravita, una lámpara icónica para explicar el significado del diseño.

• **Difusor de vidrio soplado, esfera orientable en aluminio, base en extrusión de aluminio. Acabados: transparente/cromado/anodizado negro.**

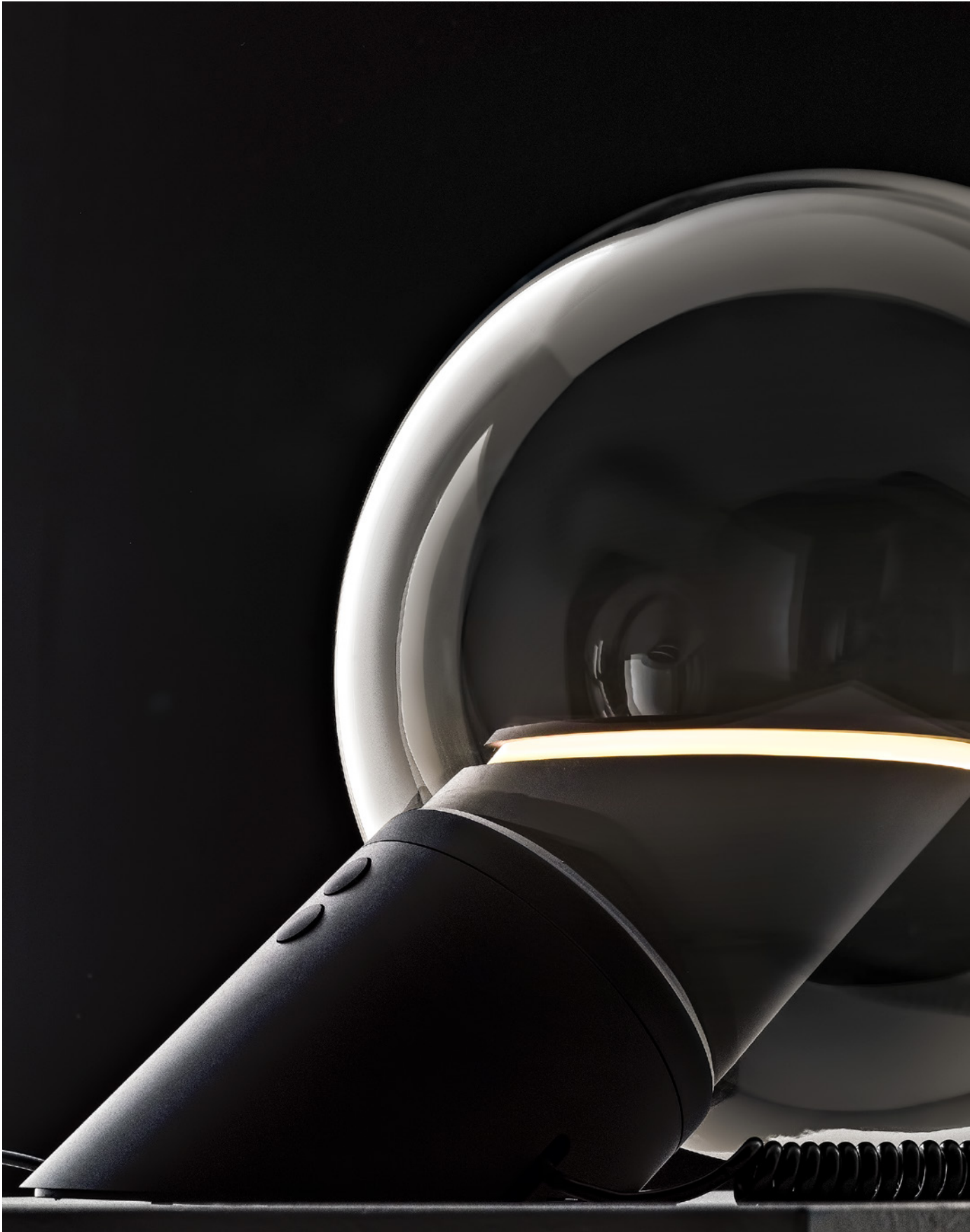







TABLE GRAVITA







1. Gravita

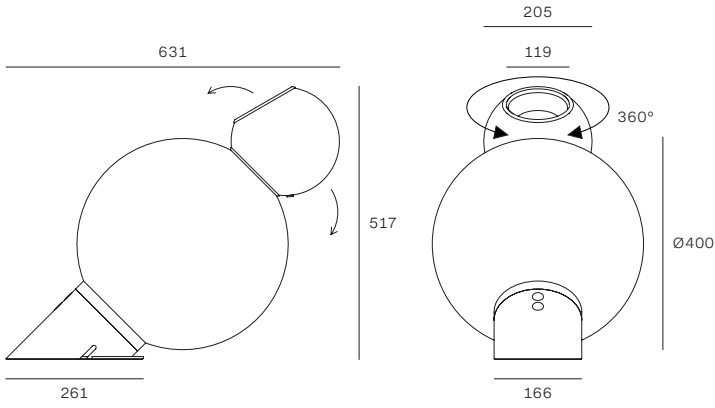

Magnetic connection between spheres



TABLE GRAVITA

STILNOVO 2023/24

MOD	CODE	FINISH	SOURCE	INPUT	DIMMING	CCT (K)	LUMEN	CRI	IP	OPTICS
1	9585	BB CH	TopLED 8W + ArrayLED 16W	220-240V	Push DIM	3000	2290	90	20	Diff. + E. W. Flood

Gravitino 541

1969

MoMA New York, Permanent Collection

Antonio Macchi Cassia

In Gravitino 541, a magnet connects the upper sphere, which houses the LED source, to the lower sphere, the base. The magnetic attachment allows total freedom of movement of the light source, which can slide in any direction and rotate 360 degrees. The light source is recessed for improved visual comfort.

• **Spheres in glossy painted metal. Finishes: white, black, red, grey, two-tone grey/red and two-tone grey/yellow.**

Dans Gravitino 541, un aimant relie la sphère supérieure, qui abrite la source LED, à la sphère inférieure, la base. La fixation magnétique permet une totale liberté de mouvement de la source lumineuse, qui peut glisser dans n'importe quelle direction et tourner à 360 degrés. La source lumineuse est en retrait pour un meilleur confort visuel.

• **Boules en métal peint brillant. Finitions : blanc, noir, rouge, gris, bicolore gris/rouge et bicolore gris/jaune.**

En Gravitino 541, un imán conecta la esfera superior, que alberga la fuente LED, con la esfera inferior que forma la base. La fijación magnética permite una total libertad de movimiento de la fuente luminosa, que puede deslizarse en cualquier dirección y girar 360 grados. La fuente de luz queda retraída para un mayor confort visual.

• **Esferas de metal pintado brillante. Acabados: blanco, negro, rojo, gris, bicolor gris/rojo y bicolor gris/amarillo.**







1. Gravitino 541

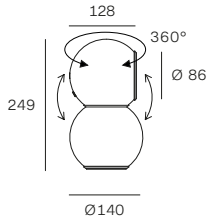

Magnetic connection between spheres



Discover movements,
light and colours of
Gravitino 541

MOD	CODE	FINISH	SOURCE	INPUT	DIMMING	CCT (K)	LUMEN	CRI	IP	OPTICS
1	9711	WH WH	ArrayLED 11W	220-240V	Push DIM	3000	1079	90	20	Extra Wide Flood
	9712	BB BB	ArrayLED 11W	220-240V	Push DIM	3000	1079	90	20	Extra Wide Flood
	9713	GG RI	ArrayLED 11W	220-240V	Push DIM	3000	1079	90	20	Extra Wide Flood
	9714	RI RI	ArrayLED 11W	220-240V	Push DIM	3000	1079	90	20	Extra Wide Flood
	9715	GG GG	ArrayLED 11W	220-240V	Push DIM	3000	1079	90	20	Extra Wide Flood
	9716	GG YY	ArrayLED 11W	220-240V	Push DIM	3000	1079	90	20	Extra Wide Flood

Other versions: wall/ceiling, p. 298.

Halley

2005 (re-edition 2023)

Richard Sapper

Halley is an orbital structure that literally allows all possible movements while remaining in position, by moving the lamp head using only one hand. With no fewer than 6 joints, each with 360 degrees of rotation, the lamp can move freely in three-dimensional space. The sphere acts as a counter-balance for the weight of the luminaire, ensuring stability.

• **Anodised aluminium body and head. Zamac base.**
Finishes: black or silver. Black base and counter-weights.

Halley est une structure orbitale qui permet littéralement tous les mouvements possibles, en restant immobile dans sa position, en déplaçant la tête de la lampe et en n'utilisant qu'une seule main. Avec pas moins de 6 articulations et 360 degrés de rotation pour chacune d'entre elles, la lampe peut se déplacer librement dans un espace tridimensionnel. La boule sert de balancier pour l'ensemble du poids de l'appareil, ce qui assure sa stabilité.

• **Corps et tête en aluminium anodisé. Base en zamak.**
Finitions : noir ou argent anodisé. Base et contrepoids noirs.

Halley es una estructura orbital que literalmente permite todos los movimientos posibles, manteniéndose fija en su posición, moviendo el cabezal de la lámpara y usando solo una mano. Gracias a 6 articulaciones y 360 grados de rotación para cada una, la lámpara puede moverse libremente en un espacio tridimensional.

La esfera actúa como equilibrador de todo el peso del aparato, garantizando su estabilidad.

• **Cuerpo y cabeza en aluminio anodizado. Base en zamak. Acabados: negro o plata anodizada. Base y contrapesos negros.**







TABLE **HALLEY**

STILNOVO 2023/24

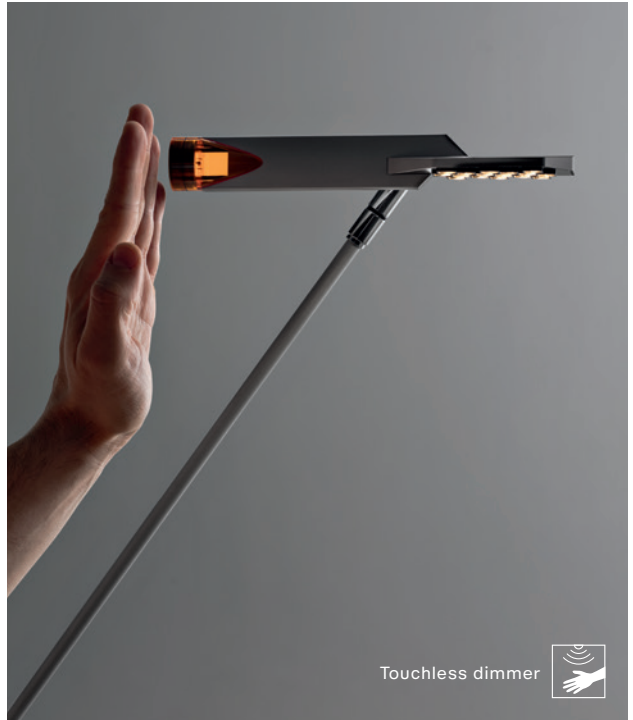



TABLE **HALLEY**

STILNOVO 2023/24

1. Halley



Touchless dimmer

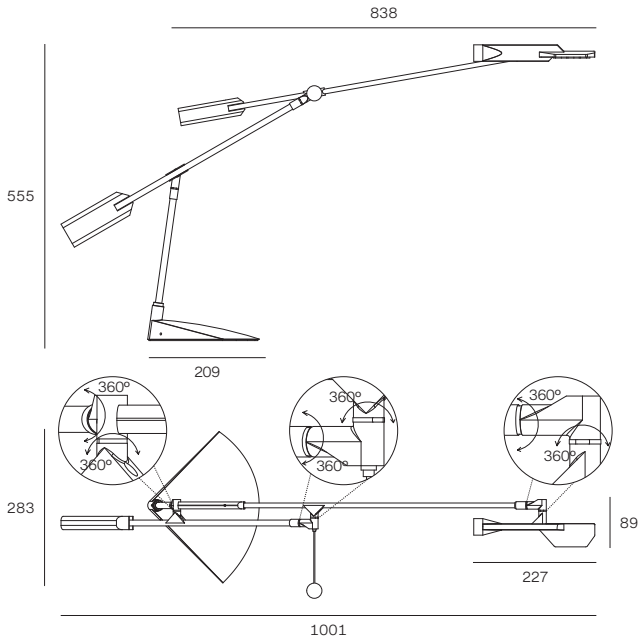

TABLE HALLEY

STILNOVO 2023/24

MOD	CODE	FINISH	SOURCE	INPUT	DIMMING	CCT (K)	LUMEN	CRI	IP	OPTICS
1	9586	AK BB	TopLED 9W	220-240V	Touchless	3000	1118	90	20	Diffused
	9587	AM BB	TopLED 9W	220-240V	Touchless	3000	1118	90	20	Diffused
	9586M	AK BB	TopLED 9W	220-240V	Touchless	2700	1040	90	20	Diffused
	9587M	AM BB	TopLED 9W	220-240V	Touchless	2700	1040	90	20	Diffused

La Mariée

2018

Mirco Crosatto

La Mariée is an ethereal sphere in blown glass with elegant pink, gold or smokey grey tones. The slightly oval shape and the hidden light source emit a soft ambient illumination that creates a play of reflections. Alone or as part of an arrangement, La Mariée adds a refined touch to the environment.

• **Blown glass casting diffuser, aluminium inner ring, metal base. Finishes: transparent/white/white, smoky grey/black/galvanic black nickel, pink/ galvanic rose gold/white, gold/galvanic gold/white.**

La Mariée est une sphère éthérée en verre soufflé dans des tons précieux de rose, d'or ou fumée. Sa forme légèrement ovale et sa source lumineuse invisible créent une lumière d'ambiance douce animée de reflets. Seule ou dans une composition, La Mariée apporte une touche d'élégance à la pièce.

• **Diffuseur en pâte de verre soufflé, anneau interne en aluminium, base en métal. Finitions : transparent/blanc/blanc, fumé/galvanisé nickel noir/noir, rose/galvanisé or rose/blanc, or/galvanisé or/blanc.**

La Mariée es una etérea esfera de vidrio soplado con preciosos tonos rosa, oro o ahumados. La forma ligeramente ovalada y la fuente invisible difunden una luz ambiental suave que juega con los reflejos. Sola o en composición, La Mariée agrega un toque refinado a los espacios.

• **Difusor en vidrio en pasta soplado, anillo interior en aluminio, base de metal. Acabados: transparente/blanco/blanco, ahumado/níquel negro galvanizado/negro, rosa/oro rosa galvanizado, oro/oro galvanizado/blanco.**





1. La Mariée

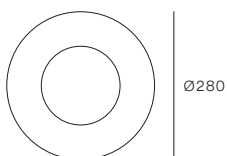
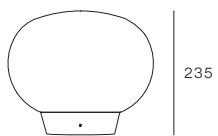

MOD	CODE	FINISH	SOURCE	INPUT	DIMMING	CCT (K)	LUMEN	CRI	IP	OPTICS
1	8628	WH TR	TopLED 9W	220-240V	Push DIM	3000	1082	90	20	Diffused
	8629	BB SG	TopLED 9W	220-240V	Push DIM	3000	1082	90	20	Diffused
	8630	WH RG	TopLED 9W	220-240V	Push DIM	3000	1082	90	20	Diffused
	8631	WH AU	TopLED 9W	220-240V	Push DIM	3000	1082	90	20	Diffused

Other versions: suspension, p. 182.

Lama

2011

Mirco Crosatto

Built into the thin Lama profile is technology comprising the topLED light source and the soft-touch switch at the base.

The unique form and light emission smooths out the contrasts and shadows on the table top, making Lama ideal in any modern space.

• **Aluminium body, polycarbonate diffuser. Finishes: white, black.**

Le profil fin de Lama intègre une technologie composée de la source topLED et de l'interrupteur soft-touch à la base, pour un éclairage tactile pratique. La forme particulière et l'émission de lumière créent des contrastes et des ombres sur le plateau de la table, ce qui rend Lama idéal dans tout espace contemporain.

• **Corps en aluminium, diffuseur en polycarbonate. Finitions : blanc, noir.**

Una tecnología formada por la fuente topLED y el interruptor soft-touch en la base se integró en el delgado perfil de Lama, para un cómodo encendido táctil. La forma especial y la emisión de la luz suavizan los contrastes y las sombras en la superficie de apoyo, convirtiendo a Lama en una opción ideal para cualquier espacio contemporáneo.

• **Cuerpo en aluminio, difusor en policarbonato. Acabados: blanco, negro.**



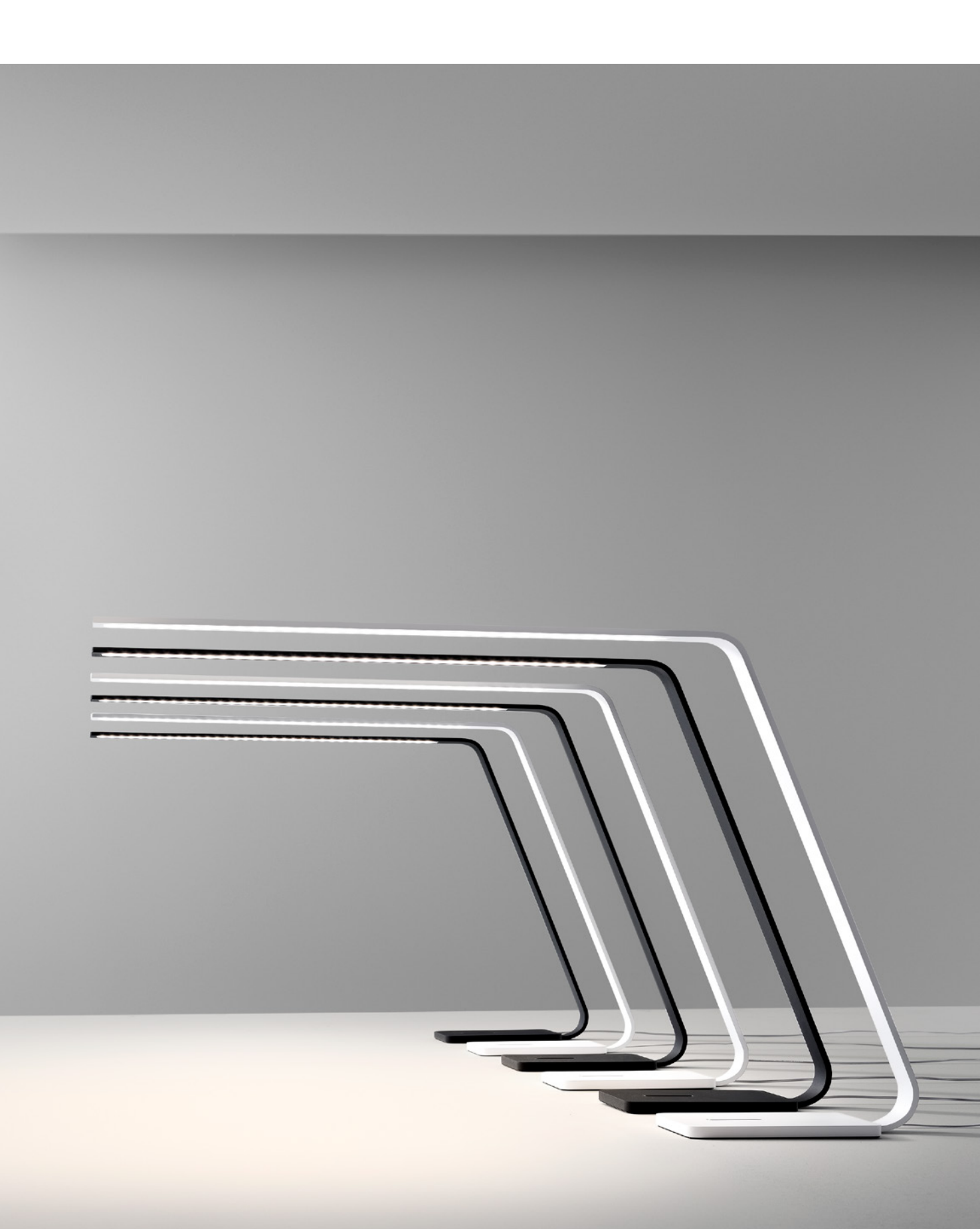



1. Lama

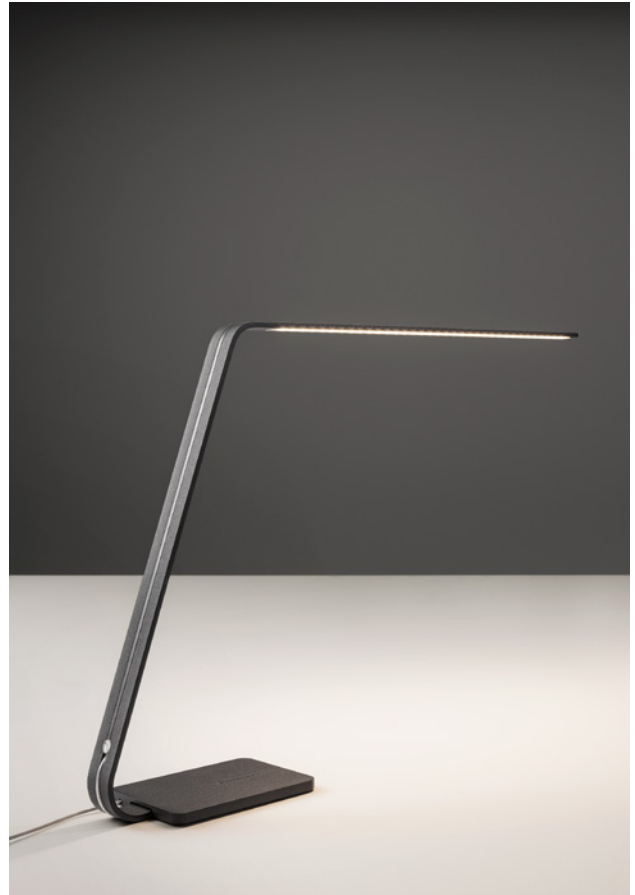
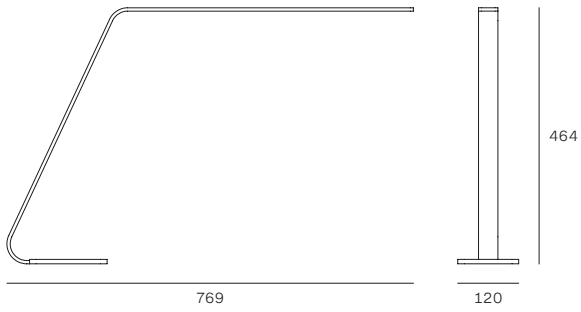

MOD	CODE	FINISH	SOURCE	INPUT	DIMMING	CCT (K)	LUMEN	CRI	IP	OPTICS
1	7112	WH	TopLED 9W	220-240V	Touch	3000	791	90	20	Diffused
	7113	BB	TopLED 9W	220-240V	Touch	3000	791	90	20	Diffused

Other versions: wall/ceiling, p. 312.

Lampiatta

1971

Jonathan De Pas
Donato D'Urbino
Paolo Lomazzi

Lampiatta can be easily repositioned without the use of joints or mechanisms. Indeed, the lampshade is designed to be inserted as desired in one of the four slots of the base, allowing the light to be inclined and directed as desired.

• **Parabolic diffuser in aluminium, body in plastic material, removable base in steel. Finishes: white/white, black/white, red/white.**

Lampiatta peut être facilement repositionnée sans l'utilisation d'articulations ou de mécanismes : l'abat-jour est conçu pour être inséré à volonté dans l'une des quatre fentes de la base, ce qui permet d'incliner et d'orienter la lumière.

• **Parabole en aluminium, corps en plastique, base amovible en acier. Finitions : blanc/blanc, noir/blanc, rouge/blanc.**

Lampiatta se puede repositionar fácilmente sin el uso de juntas o mecanismos: la pantalla está diseñada para insertarse como se desee en una de las cuatro ranuras de la base, permitiendo la inclinación y orientación de la luz.

• **Parábola en aluminio, cuerpo en material plástico, base extraíble en acero. Acabados: blanco/blanco, negro/blanco, rojo/blanco.**





1. Lampiatta table/wall



Included bulb
Classic A Mirror
LED Bulb E27 7W

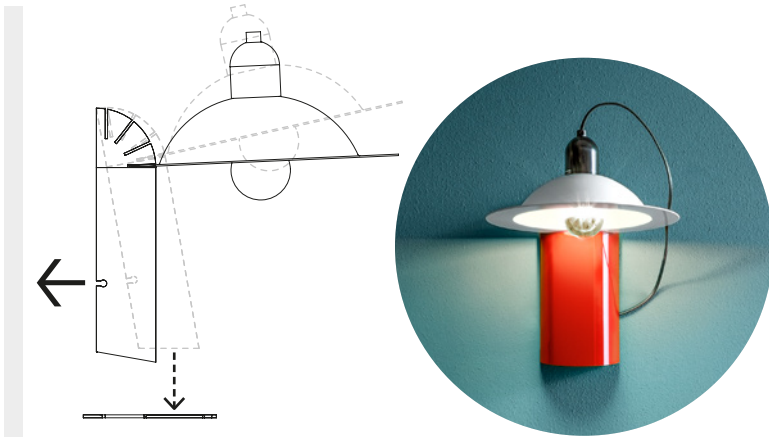
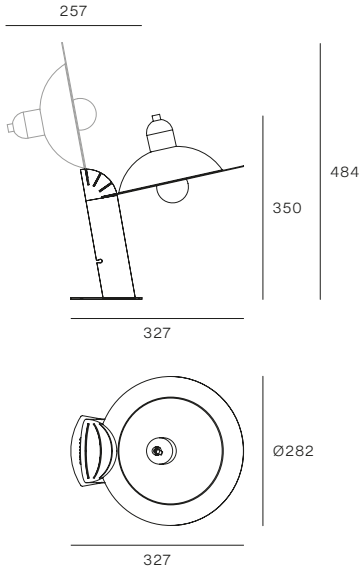

By removing the steel base from the body lamp, Lampiatta can be wall mounted.
Si vous retirez la base en acier, Lampiatta peut être fixée au mur.
Lampiatta se puede instalar en pared retirando la base de acero del cuerpo de la lámpara.

MOD	CODE	FINISH	SOURCE	INPUT	DIMMING	CCT (K)	LUMEN	CRI	IP	OPTICS
1	8971	WH WH	1xE27 7W	220-240V	No	2700	650	≥80	20	Diffused
	8972	BB WH	1xE27 7W	220-240V	No	2700	650	≥80	20	Diffused
	8973	RR WH	1xE27 7W	220-240V	No	2700	650	≥80	20	Diffused

Wall-mounted: p. 316. Other versions: suspension, p. 186.

Megafono

1958

Stilnovo

Megafono is an iconic 1950s lamp with both direct and indirect light. The double-cone directable lampshade, with an ivory or glossy black finish, is combined with the precious brass stem with galvanic gilding, to illuminate with a refined touch.

• **Brass body, metal shade and base. Finishes: brass with galvanic gilding, black or ivory lampshades.**

Megafono est une lampe emblématique des années 1950 avec une lumière directe et indirecte. L'abat-jour à double cône réglable, en finition ivoire ou noir brillant, est associé à la tige en laiton précieux dorure galvanique, pour éclairer avec une touche raffinée.

• **Corps en laiton, abat-jour et base en métal. Finitions : laiton avec dorure galvanique, abat-jour noir ou bien ivoire.**

Megafono es una icónica lámpara de los años 50 con luz directa e indirecta. La lámpara orientable de doble cono, en acabado marfil o negro brillante, se combina con la varilla de latón con dorado galvánico para iluminar con un toque refinado.

• **Cuerpo en latón, pantalla y base de metal. Acabados: latón con dorado galvánico, pantallas en negro o marfil.**

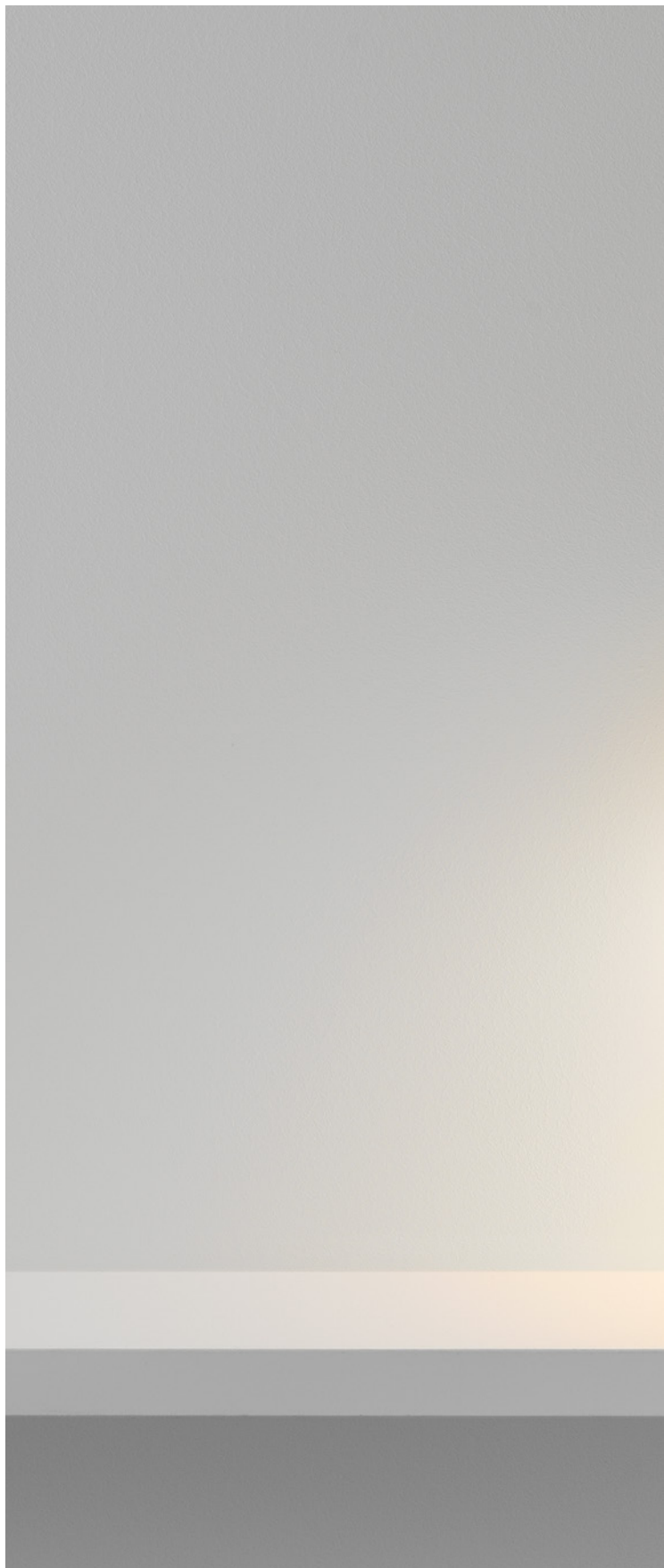





1. Megafono



Included bulbs
Miniglobo P45
LED Bulb E14 6W

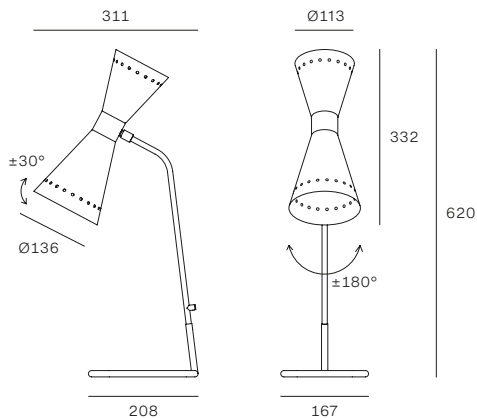

TABLE MEGAFONO

STILNOVO 2023/24

MOD	CODE	FINISH	SOURCE	INPUT	DIMMING	CCT (K)	LUMEN	CRI	IP	OPTICS
1	9574	AU BB	2xE14 6W	220-240V	No	2700	1612	≥80	20	Diffused
	9575	AU IV	2xE14 6W	220-240V	No	2700	1612	≥80	20	Diffused

Other versions: suspension, p. 194; wall/ceiling, p. 320.

Meta

1970

Stilnovo

An icon of Italian design, Meta by Stilnovo was first launched in the 70s and today returns as concrete testimony to elegance through pure form. A handful of pencil strokes are enough to create a masterpiece of simple minimalist lines.

• **Metal structure and cylindrical base, Triplex glass diffuser. Finishes: red, black or brushed gold structure with black base, or white structure with white base. Glossy white glass.**

Ícone du design italien, Meta de Stilnovo est née dans les années 1970 et revient aujourd'hui comme un témoignage concret de l'élégance par la forme pure. Avec des lignes simples et essentielles, il prend vie grâce à quelques coups de crayon, suffisants pour créer un chef-d'œuvre.

• **Structure et base cylindrique en métal, diffuseur en verre triplex. Finitions : structure rouge, noire ou or brossé avec base noire, ou blanche avec base blanche. Verre blanc brillant.**

Ícono del diseño italiano, Meta di Stilnovo nació en los años 70 y vuelve hoy como testigo concreto de la elegancia a través de la forma pura. Mediante líneas simples y esenciales, cobra vida gracias a unas pocas marcas de lápiz, suficientes para crear una obra maestra.

• **Estructura y base cilíndrica en metal, difusor de cristal triplex. Acabados: estructura roja, negra o de oro cepillado con base negra, o bien blanca con base blanca. Vidrio blanco brillante.**







1. Meta



Included bulb
Classic A 150 Dimmable
LED Bulb E27 20W

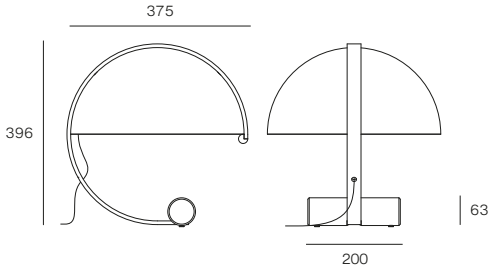

MOD	CODE	FINISH	SOURCE	INPUT	DIMMING	CCT (K)	LUMEN	CRI	IP	OPTICS
1	9698	WH WH	1xE27 20W	220-240V	Push DIM	2700	2452	≥80	20	Diffused
	9699	BB BB	1xE27 20W	220-240V	Push DIM	2700	2452	≥80	20	Diffused
	9700	Rt BB	1xE27 20W	220-240V	Push DIM	2700	2452	≥80	20	Diffused
	9701	HG BB	1xE27 20W	220-240V	Push DIM	2700	2452	≥80	20	Diffused

Minibox

1981

Gae Aulenti
Piero Castiglioni

The table-top Minibox is comprised of a metal body, a comfortable handle and an irreverent luminous eye, which recalls the aesthetics of a miners' lamp.

The magnetic attachment of the head allows the light to be directed, rendering it suitable for any location, even the most unexpected.

• **Metal body and directable head with magnetic coupling. Finishes: white, black, coffee, green, red.**

Minibox de table est composée d'un corps en métal, d'une poignée confortable et d'un œil lumineux irrévérencieux, qui rappelle l'esthétique des lampes de mineurs.

Le couplage magnétique de la tête vous permet d'orienter la lumière, ce qui la rend adaptée à tout endroit, même le plus inattendu.

• **Corps et tête métalliques orientables avec accouplement magnétique. Finitions : blanc, noir, café, vert, rouge.**

Minibox de mesa está compuesta por un cuerpo metálico, un cómodo agarre y un irreverente ojo brillante, que remite a la estética de las lámparas de los mineros. El acoplamiento magnético del cabezal permite orientar la luz, haciéndola adecuada para cualquier lugar, incluso el más ine

• **Cuerpo y cabezal orientable en metal con acoplamiento magnético. Acabados: blanco, negro, café, verde, rojo.**







1. Minibox

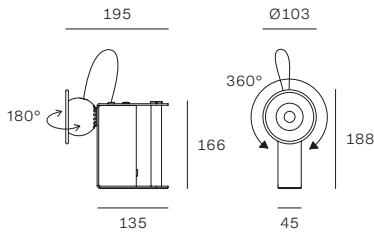

Magnetic head-body connection



Discover movements, light and colours of Minibox



MOD	CODE	FINISH	SOURCE	INPUT	DIMMING	CCT (K)	LUMEN	CRI	IP	OPTICS
1	9285	WH	PowerLED 10W	220-240V	Push DIM	3000	620	90	20	M.W.Flood
	9286	BB	PowerLED 10W	220-240V	Push DIM	3000	620	90	20	M.W.Flood
	9287	CF	PowerLED 10W	220-240V	Push DIM	3000	620	90	20	M.W.Flood
	9288	GR	PowerLED 10W	220-240V	Push DIM	3000	620	90	20	M.W.Flood
	9289	RR	PowerLED 10W	220-240V	Push DIM	3000	620	90	20	M.W.Flood

Other versions: wall/ceiling, p. 324.

Minitopo

1970

MoMA New York, Permanent Collection

Joe Colombo

Minitopo is a fascinating object of automotive inspiration: the slits on the body are reminiscent of the vents on a 1960s sports car, whilst the lampshade's form corresponds to the shell of the classic E27 bulb it contains, like the bodywork covering an engine. The resulting form resembles a little mouse (or, 'topo' in Italian), hence the ironic name. The light is can be directed via the black handle, which represents the mouse's tail, positioned on the light reflector.

• **Metal shell, handle in heat-insulating material, metal shaft. Finishes: white/chrome, black/chrome, red/chrome, green/chrome, gold/black, full chrome, full iconic red.**

Minitopo est un fascinant objet d'inspiration automobile : les fentes de la coque rappellent les prises d'air des voitures de sport des années 1960, tandis que la forme de l'abat-jour correspond à l'enveloppe de l'ampoule classique E27 logée à l'intérieur, comme un corps sur le moteur sous-jacent La forme qui en résulte fait penser à une souris, d'où le nom ironique. La lumière peut être librement dirigée par la poignée noire, la queue, placée sur le réflecteur.

• **Coque métallique, poignée en matériau thermo-isolant, tige métallique. Finitions : blanc/chromé, noir/chromé, rouge/chromé, vert/chromé, or/noir, full chrome, full iconic red.**

Minitopo es un fascinante objeto de inspiración automovilística: las ranuras en la carcasa recuerdan las tomas de aire de los automóviles deportivos de la década de 1960, mientras que la forma de la pantalla corresponde a la envoltura de la clásica bombilla E27 alojada en su interior, como una carrocería con el motor debajo. La forma resultante recuerda a un ratón, de ahí el irónico nombre. La luz es orientable libremente mediante el mango negro, la cola, situada en el reflector.

• **Carcasa en metal, mango en material termoaislante, varilla en metal. Acabados: blanco/cromo, negro/cromo, rojo/cromo, verde/cromo, oro/cromo, full chrome, full iconic red.**







TABLE **MINITOPO**

STILNOVO 2023/24



TABLE MINITOPPO

STILNOVO 2023/24

1. Minitopo



Included bulb
Classic A Retrofit
LED Bulb E27 7W

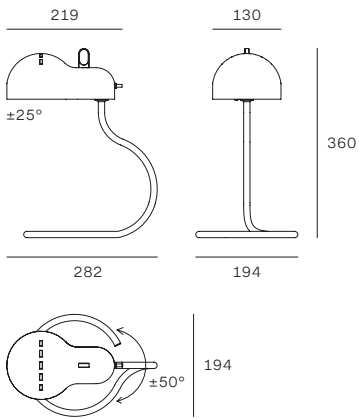

MOD	CODE	FINISH	SOURCE	INPUT	DIMMING	CCT (K)	LUMEN	CRI	IP	OPTICS
1	9064	RI RI	1xE27 7W	220-240V	No	2700	806	≥80	20	Diffused
	9065	WH CH	1xE27 7W	220-240V	No	2700	806	≥80	20	Diffused
	9066	BB CH	1xE27 7W	220-240V	No	2700	806	≥80	20	Diffused
	9067	RR CH	1xE27 7W	220-240V	No	2700	806	≥80	20	Diffused
	9068	GR CH	1xE27 7W	220-240V	No	2700	806	≥80	20	Diffused
	9069	CH CH	1xE27 7W	220-240V	No	2700	806	≥80	20	Diffused
	9070	AU BB	1xE27 7W	220-240V	No	2700	806	≥80	20	Diffused

Periscopio

1967

MoMA New York, Permanent Collection

Danilo & Corrado Aroldi

Designed in the space age, the joint is covered with flexible rubber, reminiscent of the articulations in a space suit. The joint and arm rotation system allow the Periscope to be adjusted to any position. The distinctive LED source is half covered by a silver surface to prevent glare.

• **Stainless steel body, flexible rubber joint, metal base. Finishes: red, white or black tubular lamp body. Black base and joint.**

Conçu en pleine « ère spatiale », le caoutchouc souple qui recouvre l'articulation rappelle les joints des combinaisons des astronautes. Le système d'articulation et de rotation du bras permet d'ajuster le périscope à pratiquement n'importe quelle position. La source LED spéciale, dont la moitié est recouverte d'une surface argentée, évite les éblouissements.

• **Corps en acier inoxydable, joints flexibles en caoutchouc, base métallique. Finitions : corps tubulaire rouge, blanc ou noir. Base et articulation noires.**

Diseñada en plena "era espacial", la articulación está cubierta por una goma flexible que recuerda las juntas de los trajes de los astronautas. La articulación y el sistema de rotación del brazo permiten ajustar el Periscopio en prácticamente cualquier posición. La fuente LED especial, cubierta a la mitad por una superficie plateada, permite evitar deslumbramientos. • **Cuerpo de acero inoxidable, articulaciones de goma flexible, base de metal. Acabados: cuerpo tubular rojo, blanco o negro. Base y articulación negras.**

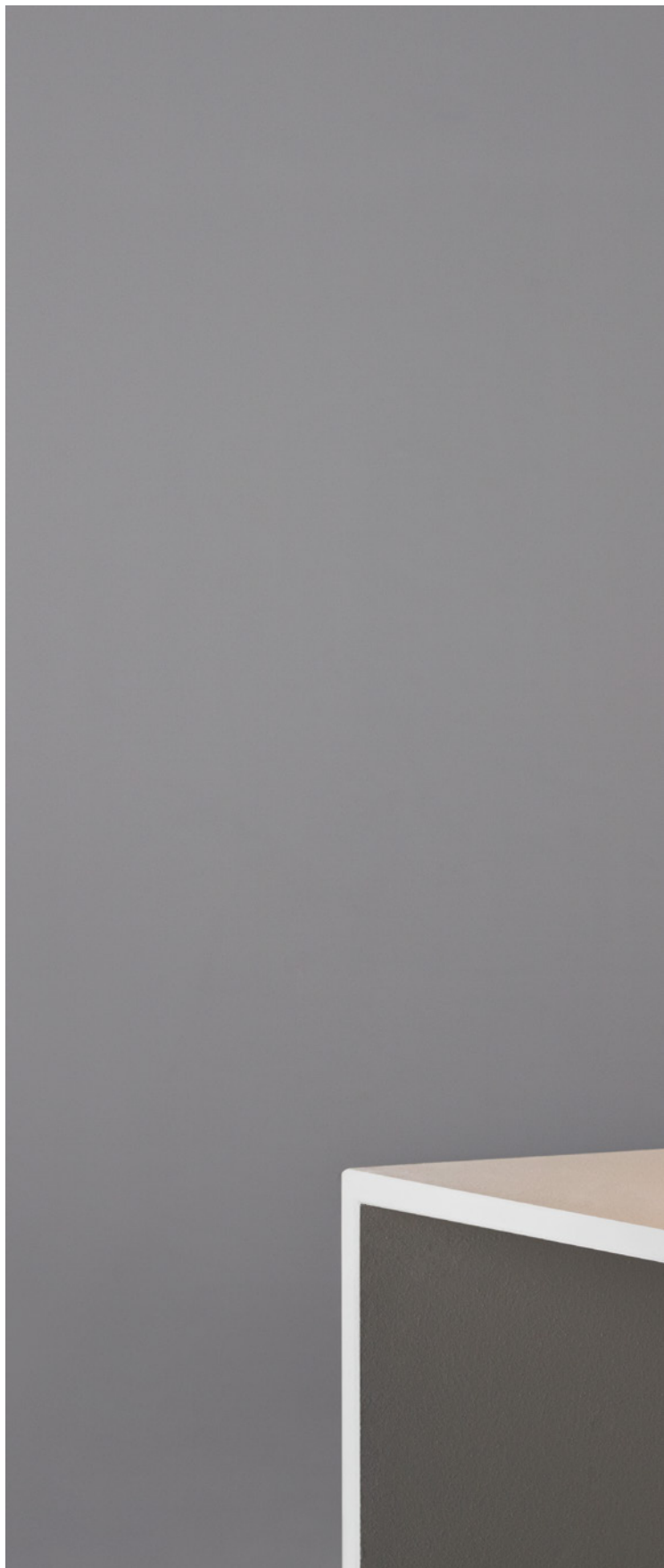



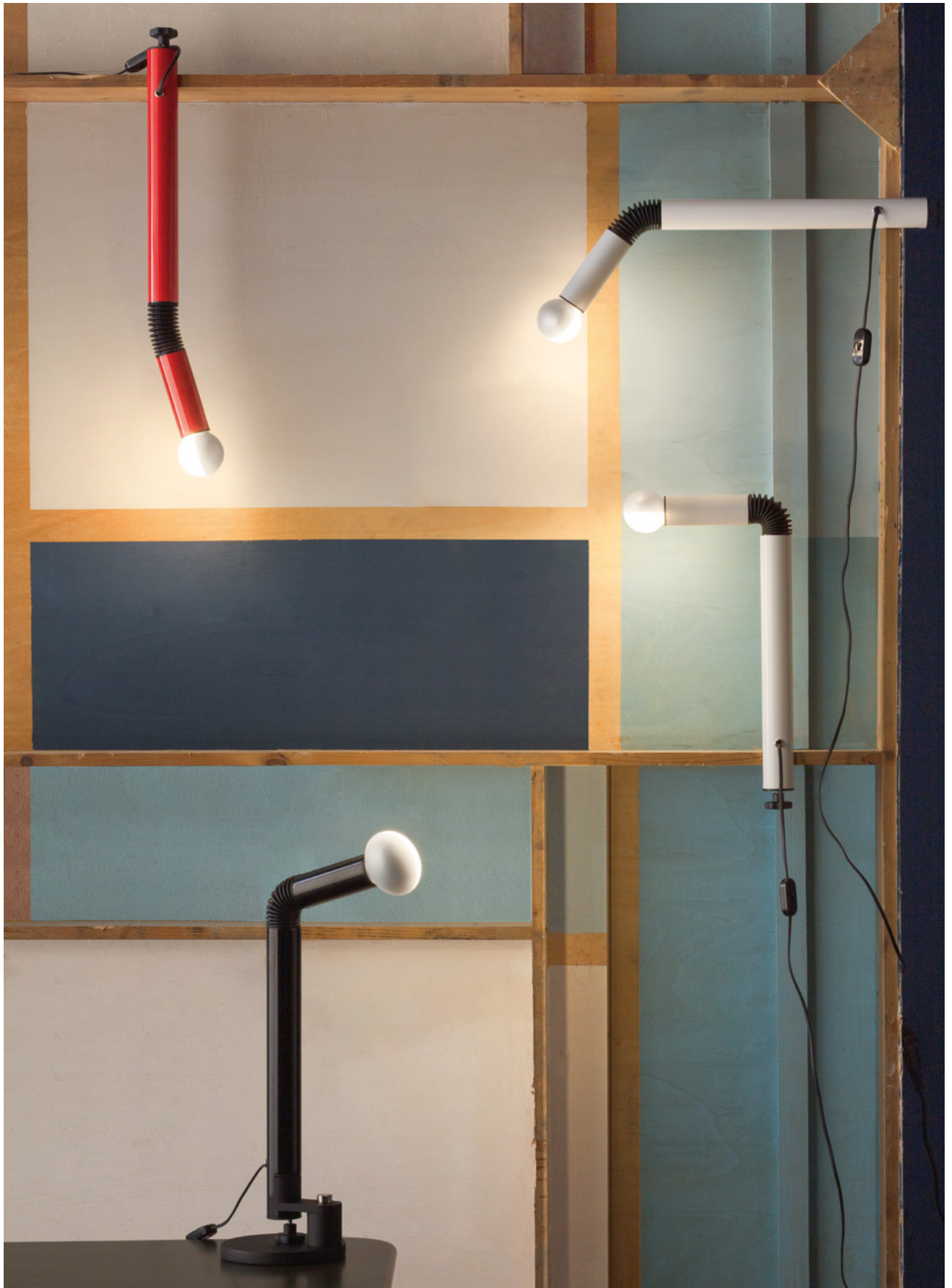

1. Periscopio



Included bulb
LED Bulb G9 7W

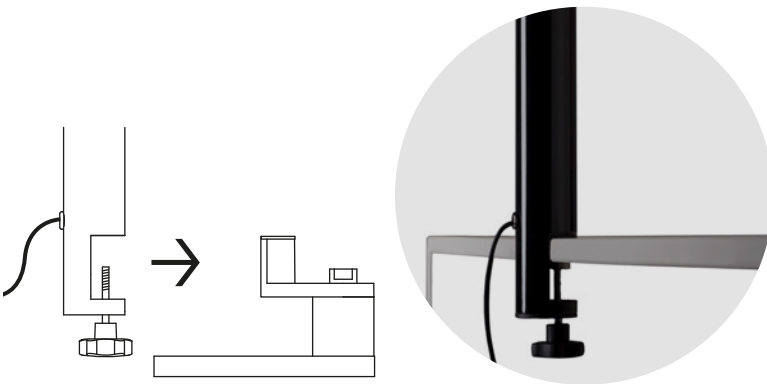
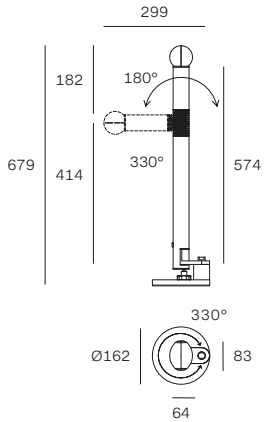

By removing the metal base, Periscopio can be used as a clamp lamp.
Si vous retirez la base en métal, Periscopio peut être utilisé comme lampe à pince.
Periscopio se puede utilizar como lámpara de pinza retirando la base metálica.

MOD	CODE	FINISH	SOURCE	INPUT	DIMMING	CCT (K)	LUMEN	CRI	IP	OPTICS
1	9055	WH BB	1xG9 7W	220-240V	No	3000	700	≥80	20	Diffused
	9056	BB BB	1xG9 7W	220-240V	No	3000	700	≥80	20	Diffused
	9057	RI BB	1xG9 7W	220-240V	No	3000	700	≥80	20	Diffused

Other versions: floor, p. 126.

Topo

1970

Joe Colombo

Topo is a fascinating object of automotive inspiration: the slits on the metal shell are reminiscent of the vents on a 1960s sports car, whilst the lampshade's form corresponds to the casing of the classic E27 bulb it contains, like the bodywork encasing an engine. The jointed metal arms allow the lamp to be extend or retracted at will.

• **Metal shell, handle in heat-insulating material, metal arms. Metal base with external polyethylene finish or with an aluminium screw clamp. Finishes: white, black, green, chrome, iconic red.**

Topo est un fascinant objet d'inspiration automobile : les fentes sur la calotte métallique rappellent les prises d'air des voitures de sport des années 1960, tandis que la forme de l'abat-jour correspond à l'enveloppe de l'ampoule classique E27 logée à l'intérieur, comme un corps sur le moteur sous-jacent. Les bras articulés en métal permettent d'étendre ou de rétracter la lampe à volonté.

• **Coque métallique, poignée en matériau thermo-isolant, bras en métal. Base en métal avec finition externe en polyéthylène ou pince à vis en aluminium peint en noir. Finitions : blanc, noir, vert, chromé, iconique red.**

Topo es un fascinante objeto de inspiración automovilística: las ranuras en la carcasa recuerdan las tomas de aire de los automóviles deportivos de la década de 1960, mientras que la forma de la pantalla corresponde a la envoltura de la clásica bombilla E27 alojada en su interior, como una carrocería con el motor debajo. Los brazos metálicos articulados permiten extender o retraer la lámpara a voluntad.

• **Carcasa en metal, mango en material termoaislante, brazos en metal. Base de metal con acabado exterior en polietileno o abrazadera de tornillo en aluminio. Acabados: blanco, negro, verde, cromo, iconico red.**





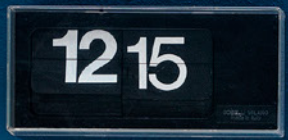

TABLE TOPO

STILNOVO 2023/24

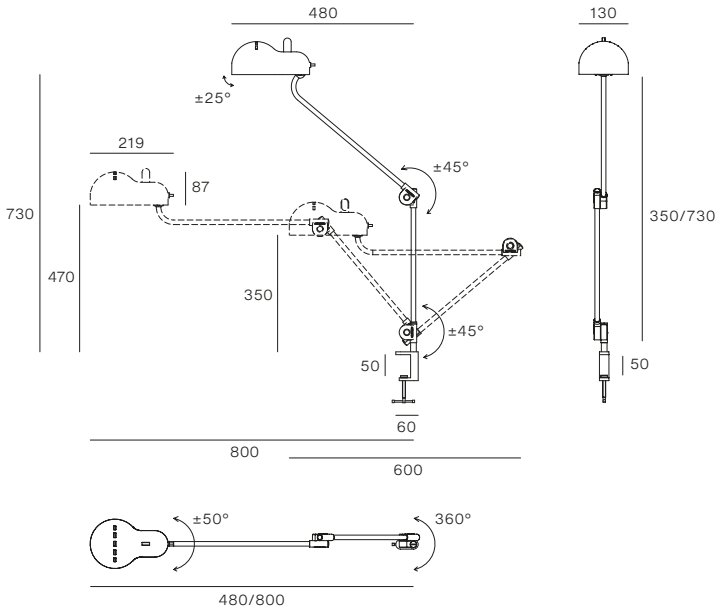

TABLE **TOPO**

STILNOVO 2023/24



1. Topo clamp



Included bulb
Classic A Retrofit
LED Bulb E27 7W

2. Topo base

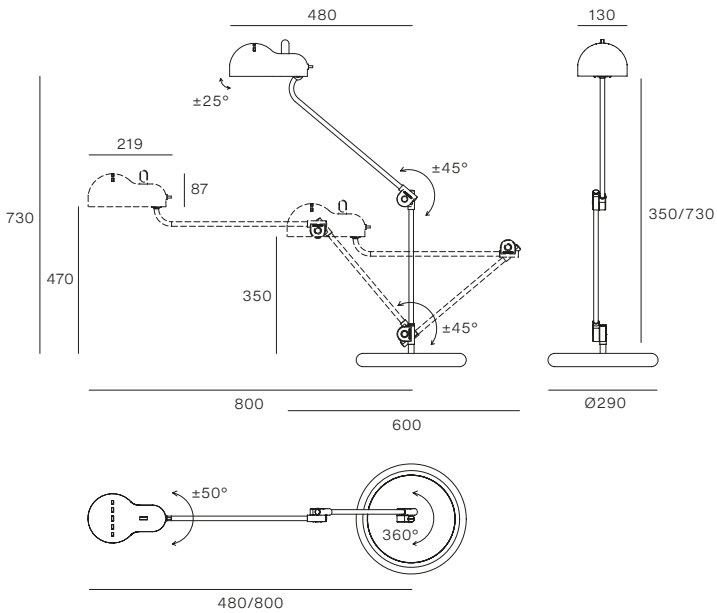

Included bulb
Classic A Retrofit
LED Bulb E27 7W

MOD	CODE	FINISH	SOURCE	INPUT	DIMMING	CCT (K)	LUMEN	CRI	IP	OPTICS
1	9071	WH	1xE27 7W	220-240V	No	2700	806	≥80	20	Diffused
	9072	BB	1xE27 7W	220-240V	No	2700	806	≥80	20	Diffused
	9073	RI	1xE27 7W	220-240V	No	2700	806	≥80	20	Diffused
	9074	GR	1xE27 7W	220-240V	No	2700	806	≥80	20	Diffused
	9075	CH	1xE27 7W	220-240V	No	2700	806	≥80	20	Diffused
2	9076	WH BB	1xE27 7W	220-240V	No	2700	806	≥80	20	Diffused
	9077	BB BB	1xE27 7W	220-240V	No	2700	806	≥80	20	Diffused
	9078	RI RI	1xE27 7W	220-240V	No	2700	806	≥80	20	Diffused
	9079	GR BB	1xE27 7W	220-240V	No	2700	806	≥80	20	Diffused
	9080	CH BB	1xE27 7W	220-240V	No	2700	806	≥80	20	Diffused

Other versions: floor, p. 134.

Valigia

1977

Ettore Sottsass Jr

Valigia is satirical and informal. The small handle and the two load-bearing arches in red piping are connected to the metal vault containing the light source. The Valigia is a small work of architecture without precise confines, clearly conceived to be taken anywhere.

• **Supporting structure and lampshade in metal. Finish: red/black.**

Valigia est ironique et informelle : la petite poignée et les deux arcs de soutien en tube rouge sont reliés à la voûte métallique, qui contient la lumière. Valigia est une petite pièce d'architecture sans limites précises, clairement conçue pour être emportée partout.

• **Structure portante et abat-jour en métal. Finitions : rouge/noir.**

Valigia es irónica e informal: la pequeña asa y los dos arcos de sujeción en tubo rojo están conectados a la bóveda metálica que contiene la luz. Valigia es una pequeña arquitectura sin límites precisos, expresamente diseñada para llevarla a cualquier parte.

• **Estructura portante y pantalla en metal. Acabado: rojo/negro.**





TABLE VALIGIA

STILNOVO 2023/24



TABLE VALIGIA



TABLE VALIGIA

STILNOVO 2023/24

1. Valigia



Included bulb
Classic A Retrofit
LED Bulb E27 7W

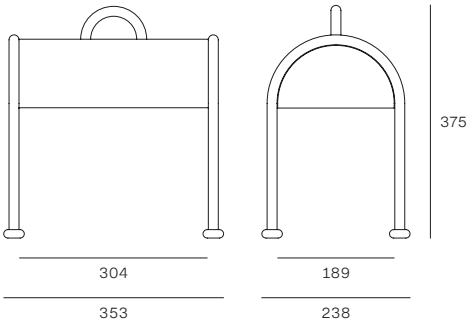

MOD	CODE	FINISH	SOURCE	INPUT	DIMMING	CCT (K)	LUMEN	CRI	IP	OPTICS
1	8960	RR BB	1xE27 7W	220-240V	No	2700	806	80	20	Diffused

Floor

Sol
Tierra

Table
Table
Mesa

14

Suspension
Suspension
Suspensión

144

Wall/ceiling
Mur/plafond
Pared/techo

264



Demí Moon	94
Diphy	98
Galassia	104
Kimia	108
Luna	112
Mr Magoo	116
Oxygen	120
Periscopio	126
Tablet	130
Topo	134
Triedro	138

Demí Moon

2023

Mirco Crosatto

When turned off, Demí Moon is a large transparent dome. Thanks to Opti-Light™ technology, when switched on, the edge and the thousands of laser micro-engravings on the surface diffuse a soft, even light. The dome hangs from a three-legged support structure; a handy release system allows it to be positioned.

• **Diffuser in transparent heat-blown PMMA. Central aluminum ring and metal tripod structure. Finishes: white or black.**

Lorsque Demí Moon est éteinte, elle devient une grande coupole transparente. Grâce à la technologie exclusive Opti-Light™, lorsqu'elle est allumée, le bord inférieur et les milliers de micro-incisions laser de la surface diffusent une lumière douce et homogène. La coupole est fixée à un trépied. Un système de déverrouillage pratique permet de faire pivoter la coupole.

• **Diffuseur transparent en PMMA thermo-soufflé. Anneau central en aluminium. Trépied en métal. Finitions : blanc ou noir.**

Cuando está apagada, Demí Moon es una gran cúpula transparente. Cuando se enciende, gracias a la tecnología Opti-Light™, el borde y los miles de micrograbados láser de la superficie difunden una iluminación suave y homogénea. La cúpula se engancha a una estructura de soporte de trípode. Un práctico sistema de desbloqueo permite orientar la cúpula.

• **Difusor en PMMA termosoplado transparente. Anillo central en aluminio. Estructura de trípode en metal. Acabados: blanco o negro.**







1. Demí Moon

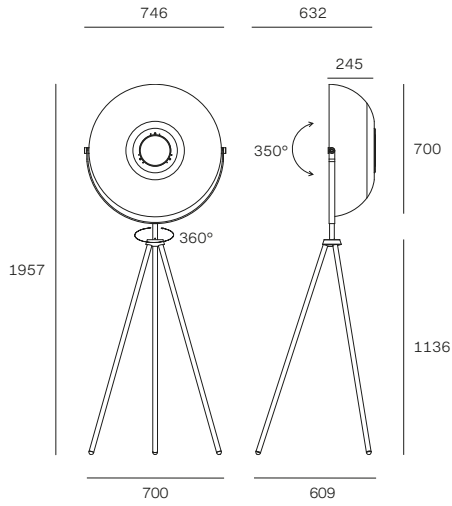

FLOOR DEMÍ MOON

MOD	CODE	FINISH	SOURCE	INPUT	DIMMING	CCT (K)	LUMEN	CRI	IP	OPTICS
1	9775	WH TR	TopLED 37W	220-240V	Push DIM	3000	4198	90	20	Diffused
	9775M	WH TR	TopLED 37W	220-240V	Push DIM	2700	3904	90	20	Diffused
	9776	BB TR	TopLED 37W	220-240V	Push DIM	3000	4198	90	20	Diffused
	9776M	BB TR	TopLED 37W	220-240V	Push DIM	2700	3904	90	20	Diffused

STILNOVO 2023/24

Diphy

2016

Mirco Crosatto

The Diphy floor lamp is a luminous and transparent petal that combines natural aesthetics with a technological soul. Suspended on a large, curved stem, light is transmitted to the edges as the micro-incisions on the surface generate soft ambient lighting. OptiLight™ technology allows Diphy to disappear from view when switched off, only to magically reappear when switched on.

• **Thermocurved PMMA diffuser, central body in aluminium, metal rod and base. Finish: white/transparent.**

Diphy est une collection de pétales lumineux et transparents qui combine une esthétique organique avec une âme technologique. La source centrale transmet la lumière aux bords sinueux et aux micro-incisions des surfaces, créant ainsi un éclairage d'ambiance doux et homogène. La technologie OptiLight™ permet à Diphy de disparaître de la vue lorsqu'il est éteint et de réapparaître comme par magie lorsqu'il est allumé.

• **Diffuseur en PMMA plié à chaud, corps central en aluminium, tige et base en métal. Finition : blanc/transparent.**

Diphy es una colección de pétalos brillantes y transparentes que combina la estética orgánica con un espíritu tecnológico. La fuente central transmite la luz a los bordes sinuosos y a las microincisiones de las superficies, creando una iluminación ambiental suave y homogénea. La tecnología OptiLight™ permite que Diphy desaparezca de la vista cuando se apaga, reapareciendo mágicamente cuando se enciende.

• **Difusor en PMMA termocurvado, cuerpo central en aluminio, cubierta de cable y base en metal. Acabado: blanco/transparente.**

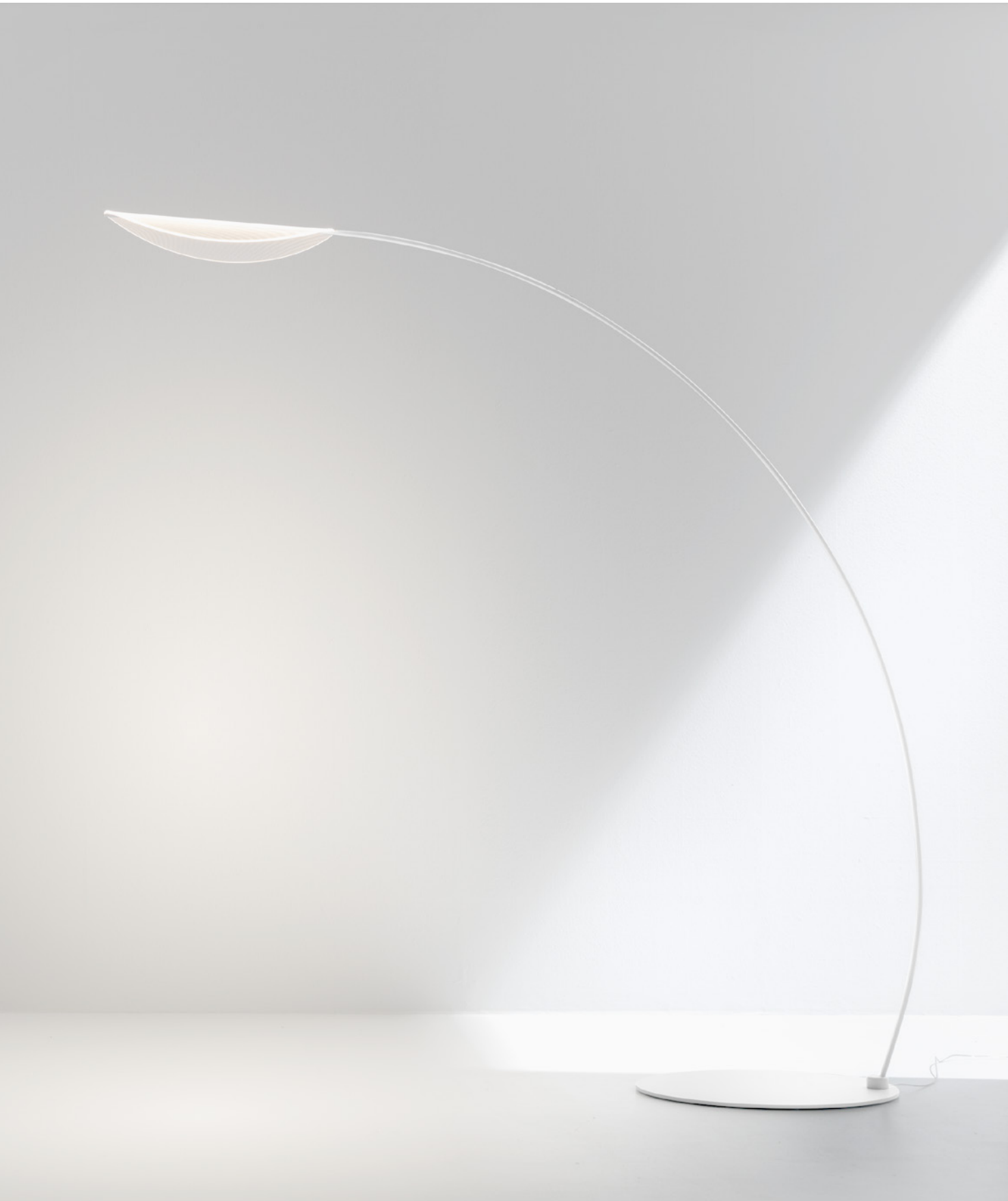



FLOOR DIPHY

STILNOVO 2023/24



FLOOR dipht

STILNOVO 2023/24



1. Diphy

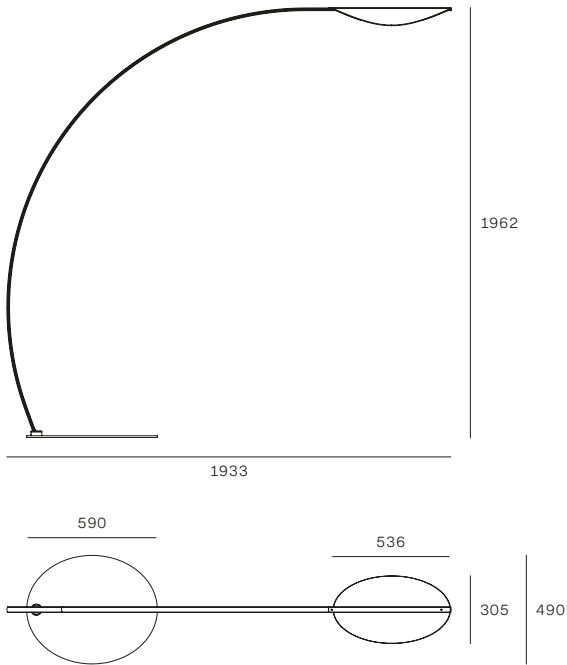

MOD	CODE	FINISH	SOURCE	INPUT	DIMMING	CCT (K)	LUMEN	CRI	IP	OPTICS
1	8165	WH TR	TopLED 30W	220-240V	Push DIM	3000	3294	90	20	Diffused
	8165M	WH TR	TopLED 30W	220-240V	Push DIM	2700	3063	90	20	Diffused

Other versions: suspension, p. 164; wall/ceiling, p. 276.

Galassia

1959

Stilnovo

The Galassia floor lamp, with the captivating movement of six white triplex glass light sources, enriches the space with a sophisticated retro touch, preserving its 1950s charm. The base in white Carrara marble embellishes what is a unique lamp.

• **Brass body, triplex glass diffusers, Carrara marble base. Finishes: brass with galvanic gilding/glossy white glass/white marble.**

Lampadaire Galassia, avec le mouvement enveloppant des six sources en verre triplex blanc, enrichit l'espace d'une touche rétro sophistiquée, tout en préservant son charme des années 1950. La base en marbre blanc de Carrara enrichit une lampe unique en son genre.

• **Corps en laiton, diffuseurs en verre triplex, base en marbre blanc de Carrara. Finitions : laiton avec dorure galvanique/verre blanc brillant/marbre blanc.**

La lámpara de pie Galassia, con el movimiento envolvente de las seis fuentes en vidrio triplex blanco, enriquece el espacio con un sofisticado toque retro, manteniendo inalterado el encanto de los años 50. La base en mármol blanco de Carrara aporta un toque de belleza adicional a una lámpara única.

• **Cuerpo en latón, difusores en vidrio triplex, base en mármol de Carrara. Acabados: latón con dorado galvanico/cristal, blanco brillante/mármol blanco.**







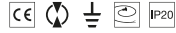

1. Galassia

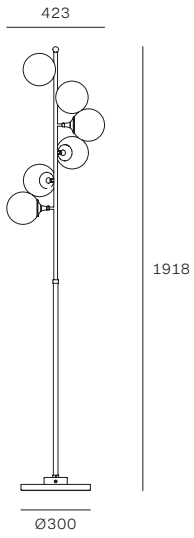

Included bulbs
 Miniglobo P45
 LED Bulb E14 6W



 Carrara marble base

MOD	CODE	FINISH	SOURCE	INPUT	DIMMING	CCT (K)	LUMEN	CRI	IP	OPTICS
1	9560	AU BB	6xE14 6W	220-240V	No	2700	4836	≥80	20	Diffused

Other versions: suspension, p. 170; wall/ceiling, p. 288.

Kimia

2018

Edin Dedovic

The Kimia illuminating disc can be rotated and moved freely along the top of the shaft, varying the direction of the light as desired, perhaps towards a wall or ceiling for ambient illumination or directed for relaxing reading.

• **Aluminium disc, polycarbonate diffuser. Brass rod, metal base. Finishes: white, black.**

Le disque lumineux de Kimia peut être tourné et déplacé librement le long du sommet de la tige, en faisant varier la direction de la lumière à volonté : vers le mur ou le plafond pour une lumière ambiante ou directe et fonctionnelle pour une lecture relaxante.

• **Disque en aluminium, diffuseur en polycarbonate. Tige en laiton et base en métal. Finitions : blanc, noir.**

El disco de iluminación de Kimia se puede girar y mover libremente a lo largo de la parte superior de la barra, variando la dirección de la luz como se desee: hacia la pared o el techo para una luz ambiental o directa y funcional para una lectura relajante.

• **Disco de aluminio, difusor en policarbonato. Varilla de latón y base de metal. Acabados: blanco, negro.**







1. Kimia

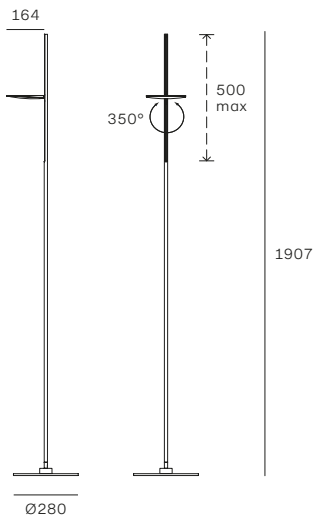

MOD	CODE	FINISH	SOURCE	INPUT	DIMMING	CCT (K)	LUMEN	CRI	IP	OPTICS
1	8545	WH	TopLED 25W	220-240V	Push DIM	3000	2534	90	20	Diffused
	8546	BB	TopLED 25W	220-240V	Push DIM	3000	2534	90	20	Diffused

Luna

2023

Shigeaki Asahara

The Luna floor lamp echoes the conical shape of the light source, while the slender body tapers towards the base, so light it seems almost to lift off the ground. The indirect light emission is extremely effective. Every detail of this highly elegant minimalist floor lamp is meticulously designed.

• **Lamp body in aluminium, metal base. Finishes: white-chrome, black-gold.**

Le lampadaire Luna reprend la forme conique de la source, tandis que le corps élancé se rétrécit jusqu'à la base, qui est si légère qu'elle semble soulevée du sol. L'émission indirecte est extrêmement efficace. Un lampadaire conçu dans les moindres détails, extrêmement minimaliste et élégant.

• **Corps de lampe en aluminium, socle en métal. Finitions : blanc-chrome, noir-or.**

La lámpara de pie Luna recupera la forma cónica de la fuente, mientras que el esbelto cuerpo se estiliza gradualmente hasta la base, tan ligera que parece levantarse del suelo. La emisión indirecta es extremadamente eficiente. Una lámpara de pie estudiada en cada detalle, extremadamente minimalista y elegante.

• **Cuerpo de la lámpara en aluminio, base en metal. Acabados: blanco-cromo, negro-oro.**







FLOOR LUNA

STILNOVO 2023/24

1. Luna

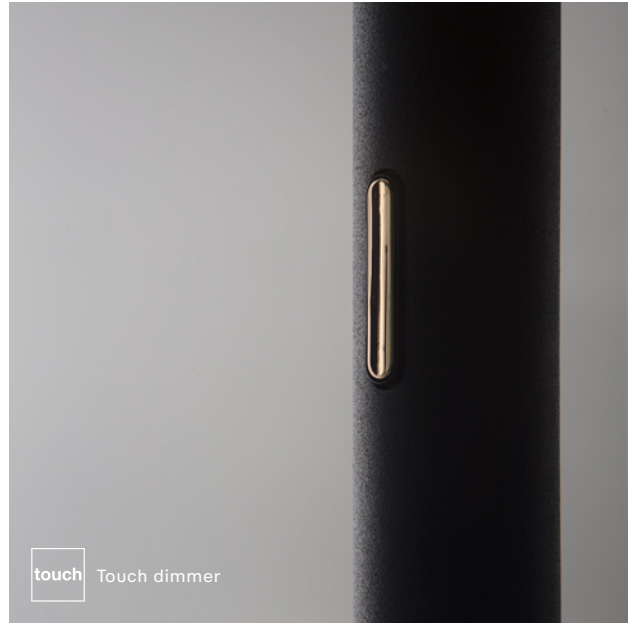
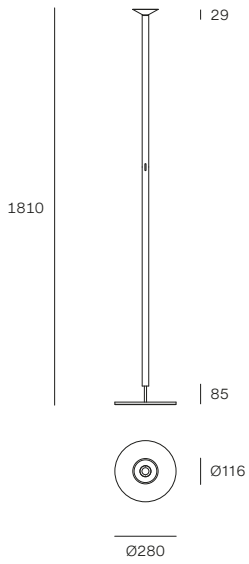

MOD	CODE	FINISH	SOURCE	INPUT	DIMMING	CCT (K)	LUMEN	CRI	IP	OPTICS
1	9707	WH CH	TopLED 27W	220-240V	Touch	3000	3015	90	20	Diffused
	9707M	WH CH	TopLED 27W	220-240V	Touch	2700	2804	90	20	Diffused
	9709	BB AU	TopLED 27W	220-240V	Touch	3000	3015	90	20	Diffused
	9709M	BB AU	TopLED 27W	220-240V	Touch	2700	2804	90	20	Diffused

Other versions: suspension, p. 190.

Mr Magoo

2010

Mirco Crosatto

The Mr Magoo floor lamp is a luminous cloud, suspended at the end of a curved stem that adorns and delights with sinuous and natural lines. The light source is entirely integrated and emits soft and diffused light.

• **Polyethylene diffuser, metal rod and base. Finish: white.**

Le lampadaire Mr Magoo est un nuage lumineux suspendu au bout d'une tige incurvée qui meuble et surprend par ses lignes sinueuses et naturelles. La source est complètement intégrée et émet une lumière douce et diffuse.

• **Diffuseur en polyéthylène, tige et base en métal. Finition : blanc.**

Mr Magoo de tierra es una nube luminosa suspendida al extremo de un tallo curvo, decorando y sorprendiendo con sus líneas sinuosas y naturales. La fuente luminosa está completamente integrada y emite una luz suave y difusa.

• **Difusor en polietileno, varilla y base de metal. Acabado: blanco.**



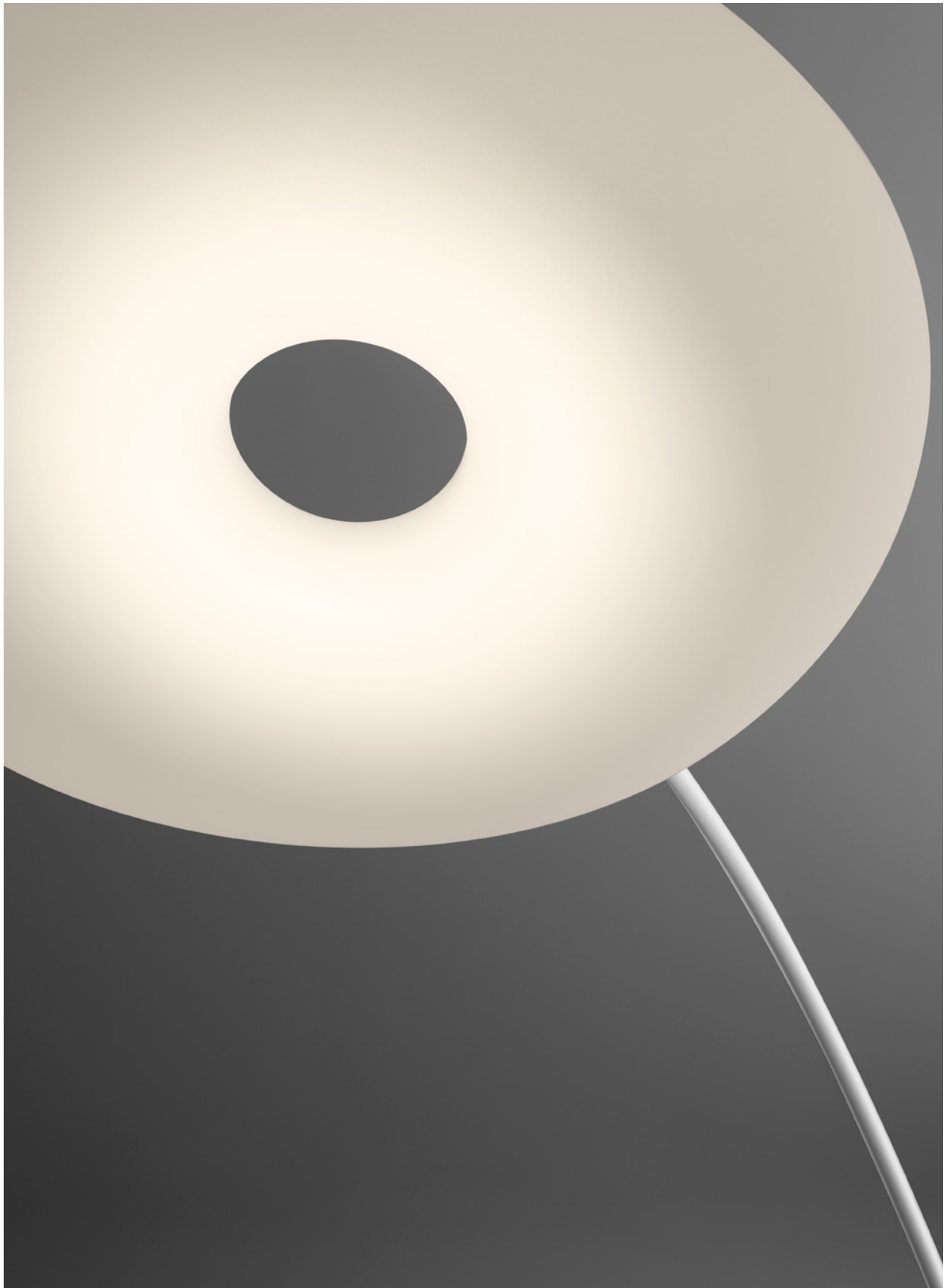

1. Mr Magoo

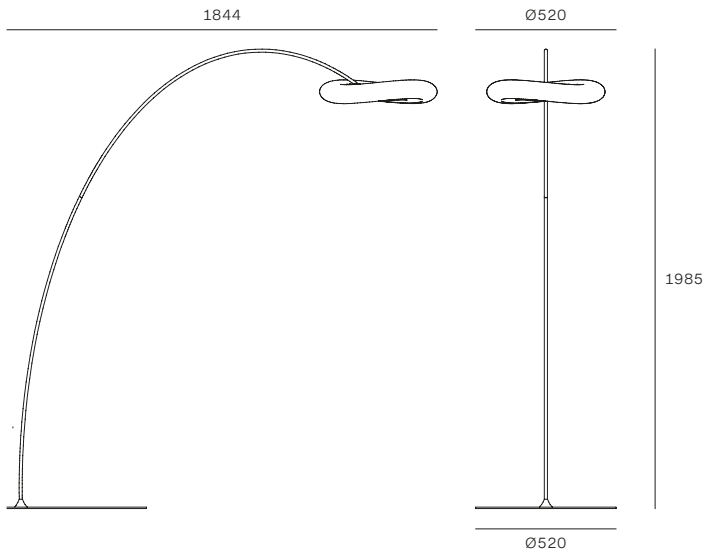

MOD	CODE	FINISH	SOURCE	INPUT	DIMMING	CCT (K)	LUMEN	CRI	IP	OPTICS
1	8009	WH	TopLED 23W	220-240V	Push DIM	3000	2189	90	20	Diffused

Other versions: suspension, p. 204; wall/ceiling, p. 328.

Oxygen

2016

Pio & Tito Toso

The Oxygen floor lamp comes in two versions with different mounts – a vertical stem and an arched support, to offer the right solution in a range of settings. The shade houses an OptiLight™ diffuser that emits precise and uniform light, both direct and indirect. Oxygen is a vast and versatile collection thanks to the various dimensions and finishes available.

• **Polyurethane lampshade, PMMA diffuser, metal rod and base. Finishes: white/white, black/white, yellow/white, light blue/white.**

Le lampadaire Oxygen a deux variantes de support : une tige verticale et une tige arquée, pour différentes solutions d'environnement. L'abat-jour abrite un diffuseur OptiLight™ qui développe une lumière directe et indirecte précise et homogène. Oxygen est une collection large et polyvalente grâce aux différentes tailles et finitions disponibles.

• **Abat-jour en polyuréthane, diffuseur en PMMA, tige et base en métal. Finitions : blanc/blanc, noir/blanc, jaune/blanc, bleu/blanc.**

Oxygen de tierra presenta dos variantes de soporte: un vástago vertical y otro arqueado, para diferentes soluciones de espacios. La pantalla aloja un difusor OptiLight™ que desarrolla una luz puntual y homogénea, directa e indirecta. Oxygen es una colección amplia y versátil, gracias a los diferentes tamaños y acabados disponibles.

• **Pantalla en poliuretano, difusor en PMMA, varilla y base de metal. Acabados: blanco/blanco, negro/blanco, amarillo/blanco, azul/blanco.**

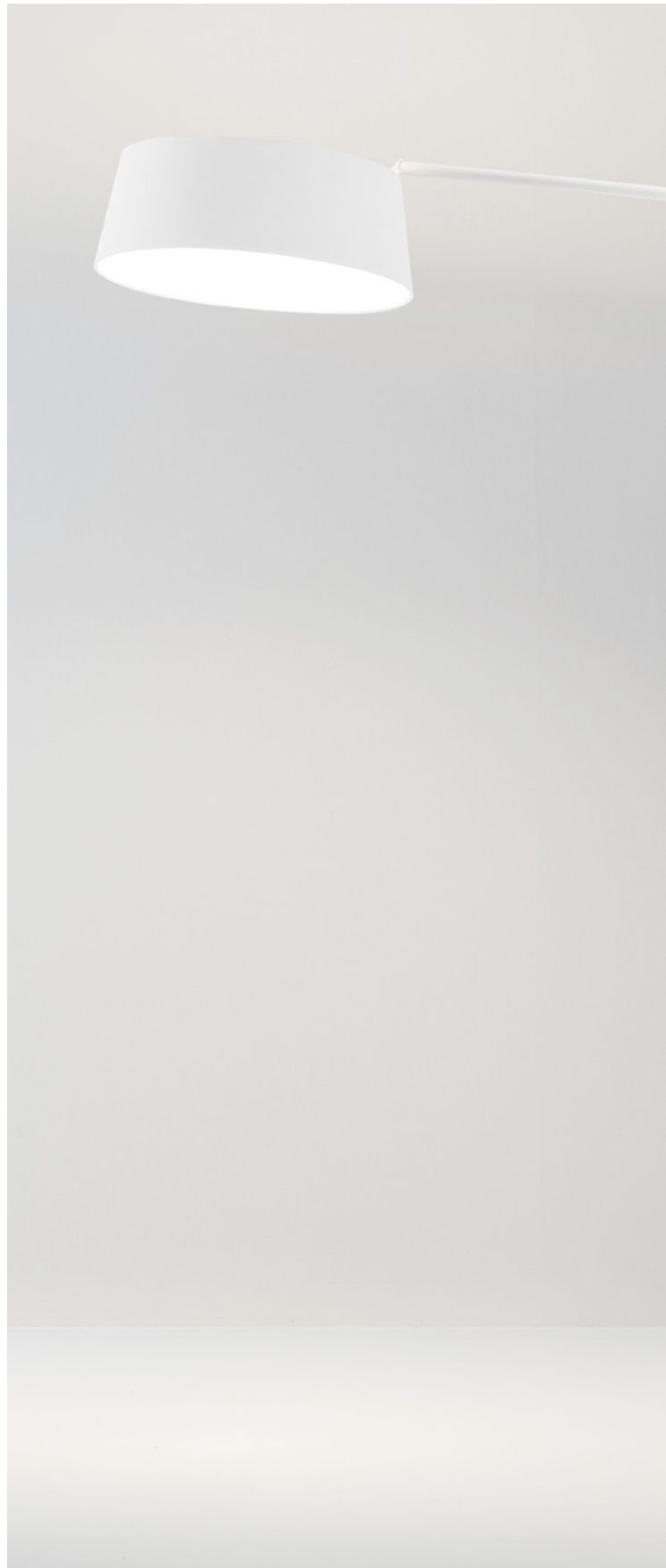







FLOOR **OXYGEN**

STILNOVO 2023/24



1. Oxygen curved rod

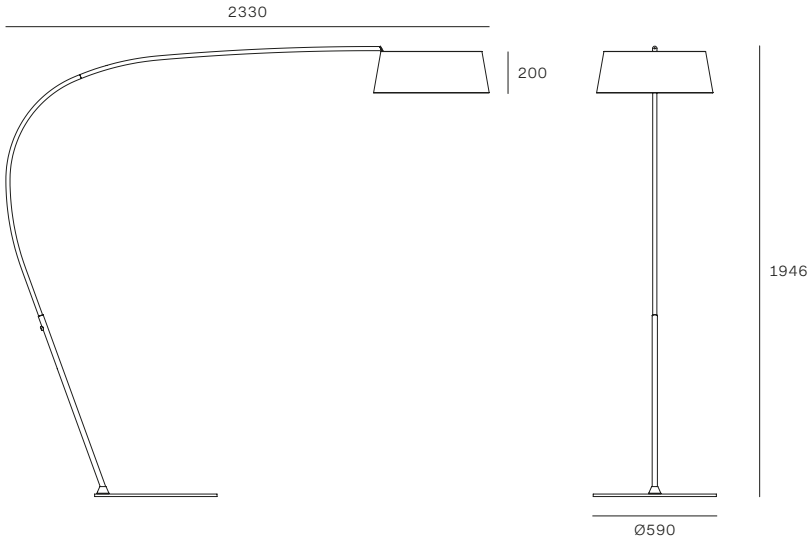

2. Oxygen straight rod

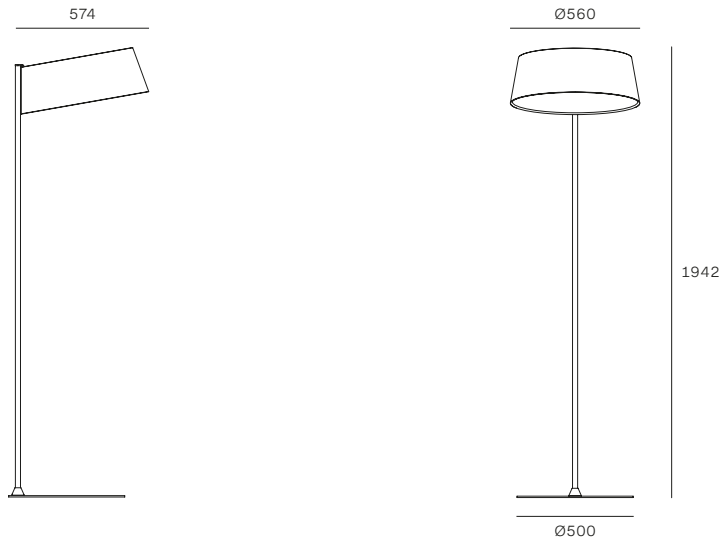

MOD	CODE	FINISH	SOURCE	INPUT	DIMMING	CCT (K)	LUMEN	CRI	IP	OPTICS
1	8101	WH WH	TopLED 36W	220-240V	Push DIM	3000	3431	90	20	Diffused
	8102	BB WH	TopLED 36W	220-240V	Push DIM	3000	3431	90	20	Diffused
	8103	YY WH	TopLED 36W	220-240V	Push DIM	3000	3431	90	20	Diffused
	8104	AZ WH	TopLED 36W	220-240V	Push DIM	3000	3431	90	20	Diffused
2	8097	WH WH	TopLED 36W	220-240V	Push DIM	3000	3431	90	20	Diffused
	8098	BB WH	TopLED 36W	220-240V	Push DIM	3000	3431	90	20	Diffused
	8099	YY WH	TopLED 36W	220-240V	Push DIM	3000	3431	90	20	Diffused
	8100	AZ WH	TopLED 36W	220-240V	Push DIM	3000	3431	90	20	Diffused

Other versions: suspension, p. 212; wall/ceiling, p.332.

Periscopio

1967

Danilo & Corrado Aroldi

Designed in the space age, the joint is covered with flexible rubber, reminiscent of the articulations in a space suit. The joint and arm rotation system allow the Periscope to be adjusted to any position. The distinctive LED source is half covered by a silver surface to prevent glare.

• **Stainless steel body, flexible rubber joint, metal base. Finishes: red, white or black tubular lamp body. Black base and joint.**

Conçu en pleine « ère spatiale », le caoutchouc souple qui recouvre l'articulation rappelle les joints des combinaisons des astronautes. Le système d'articulation et de rotation du bras permet d'ajuster le périscope à pratiquement n'importe quelle position. La source LED spéciale, dont la moitié est recouverte d'une surface argentée, évite les éblouissements.

• **Corps en acier inoxydable, joints flexibles en caoutchouc, base métallique. Finitions : corps tubulaire rouge, blanc ou noir. Base et articulation noires.**

Diseñada en plena "era espacial", la articulación está cubierta por una goma flexible que recuerda las juntas de los trajes de los astronautas. La articulación y el sistema de rotación del brazo permiten ajustar el Periscopio en prácticamente cualquier posición. La fuente LED especial, cubierta a la mitad por una superficie plateada, permite evitar deslumbramientos.

• **Cuerpo de acero inoxidable, articulaciones de goma flexible, base de metal. Acabados: cuerpo tubular rojo, blanco o negro. Base y articulación negras.**

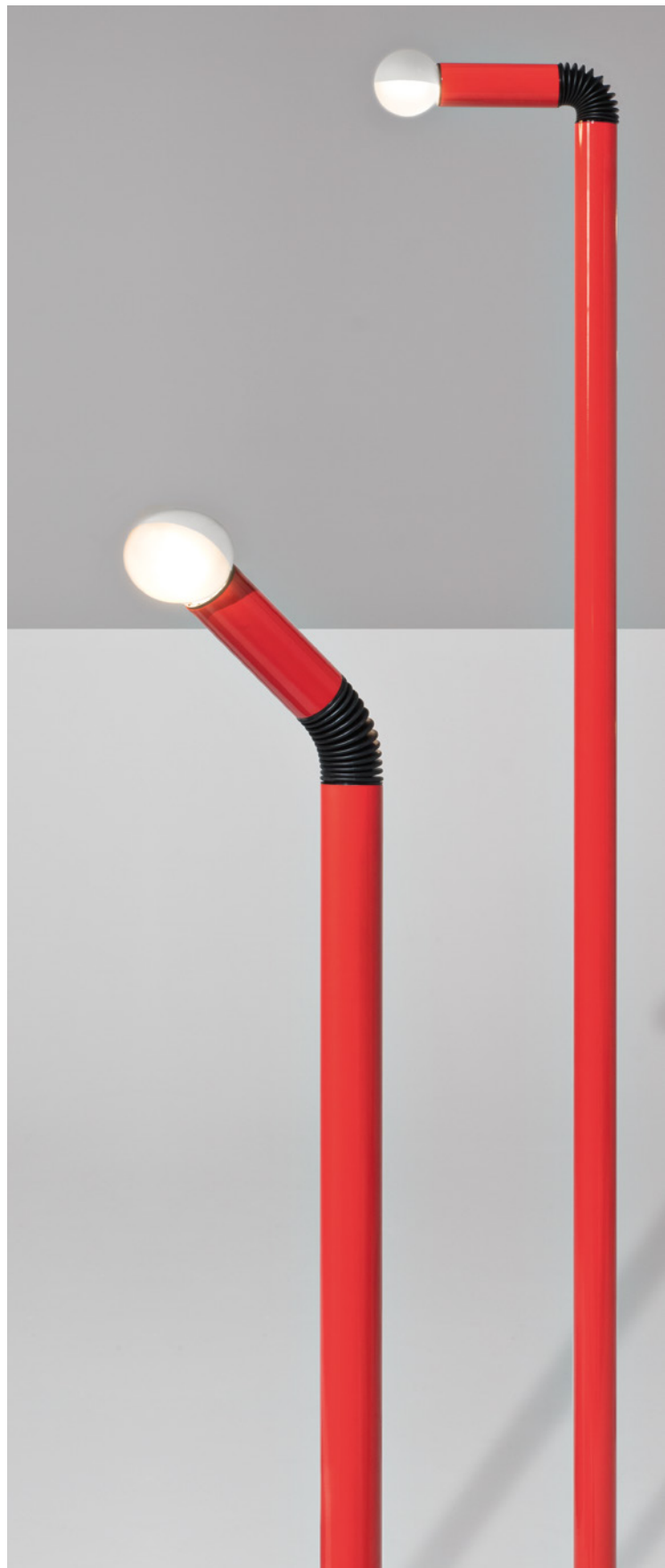





1. Periscopio

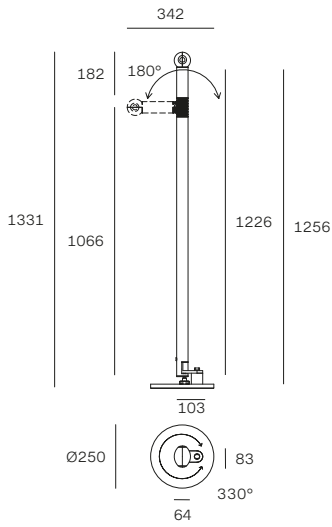

Included bulb
LED Bulb G9 7W



2. Periscopio

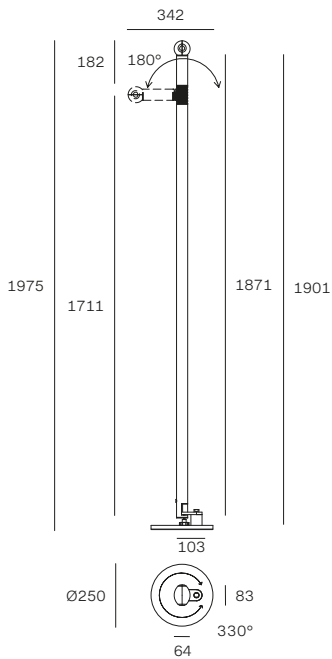

Included bulb
LED Bulb G9 7W

MOD	CODE	FINISH	SOURCE	INPUT	DIMMING	CCT (K)	LUMEN	CRI	IP	OPTICS
1	9058	WH BB	1xG9 7W	220-240V	No	3000	700	≥80	20	Diffused
	9059	BB BB	1xG9 7W	220-240V	No	3000	700	≥80	20	Diffused
	9060	RI BB	1xG9 7W	220-240V	No	3000	700	≥80	20	Diffused
2	9061	WH BB	1xG9 7W	220-240V	No	3000	700	≥80	20	Diffused
	9062	BB BB	1xG9 7W	220-240V	No	3000	700	≥80	20	Diffused
	9063	RI BB	1xG9 7W	220-240V	No	3000	700	≥80	20	Diffused

Other versions: table, p. 76.

Tablet

2014

Mirco Crosatto

Tablet is a family of minimalistic lamps with adjustable light. A thin, rectangular frame houses the mobile light sources which, thanks to the almost complete rotation on its own axis, allows the orientation of direct, indirect or combined beams of light.

• **Aluminium body, opaline polycarbonate diffuser, metal base. Finishes: white, black.**

Tablet est une famille de lampes minimalistes à lumière directionnelle. Dans un fin cadre rectangulaire sont encadrées les sources mobiles qui, grâce à la rotation presque complète sur son axe, permettent l'orientation de faisceaux lumineux directs, indirects ou combinés.

• **Corps en aluminium, diffuseur en polycarbonate opale, base en métal. Finitions : blanc, noir.**

Tablet es una familia de lámparas minimalistas con luz direccional. Las fuentes de luz en movimiento están enmarcadas en un fino marco rectangular que, gracias a la rotación casi completa sobre su eje, permite la orientación de haces de luz directa, indirecta o combinada.

• **Cuerpo en aluminio, difusor en policarbonato opalino, base de metal. Acabados: blanco, negro.**

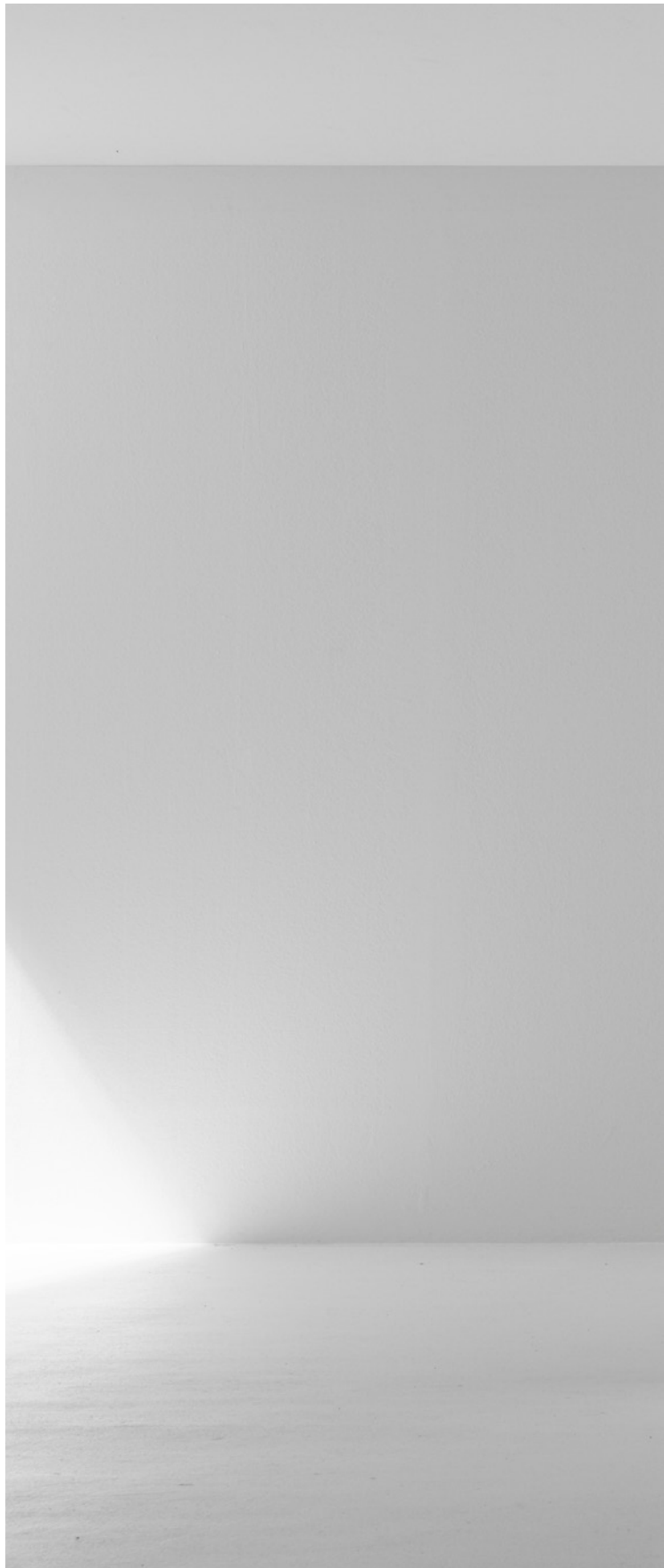





1. Tablet

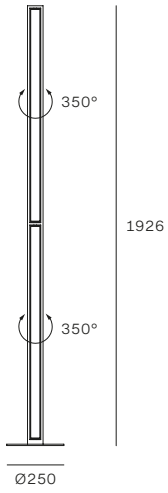

MOD	CODE	FINISH	SOURCE	INPUT	DIMMING	CCT (K)	LUMEN	CRI	IP	OPTICS
1	8452	WH	TopLED 36W	220-240V	Push DIM	3000	4640	80	20	Diffused
	8453	BB	TopLED 36W	220-240V	Push DIM	3000	4640	80	20	Diffused

Other versions: suspension, p. 246; wall/ceiling, p. 352.

Topo

1970

Joe Colombo

Topo is a fascinating object of automotive inspiration: the slits on the metal shell are reminiscent of the vents on a 1960s sports car, whilst the lampshade's form corresponds to the casing of the classic E27 bulb it contains, like the bodywork encasing an engine. The jointed metal arms allow the lamp to be extend or retracted at will.

• **Metal shell, handle in heat-insulating material, metal arms and rod, metal base with exterior polyethylene finish. Shell and arm finishes: white, black, green and chrome with black rod and base or in full iconic red.**

Topo est un fascinant objet d'inspiration automobile : les fentes sur la calotte métallique rappellent les prises d'air des voitures de sport des années 1960, tandis que la forme de l'abat-jour correspond à l'enveloppe de l'ampoule classique E27 logée à l'intérieur, comme un corps sur le moteur sous-jacent. Les bras articulés en métal permettent d'étendre ou de rétracter la lampe à volonté.

• **Coque métallique, poignée en matériau thermo-isolant, bras et tige en métal, base en métal avec finition externe en polyéthylène. Finitions de la calotte et des bras : blanc, noir, vert et chromé avec tige et base noire ou bien full iconic red.**

Topo es un fascinante objeto de inspiración automovilística: las ranuras en la carcasa recuerdan las tomas de aire de los automóviles deportivos de la década de 1960, mientras que la forma de la pantalla corresponde a la envoltura de la clásica bombilla E27 alojada en su interior, como una carrocería con el motor debajo. Los brazos metálicos articulados permiten extender o retraer la lámpara a voluntad.

• **Carcasa en metal, mango en material termoaislante, brazos y varilla en metal, base en metal con acabado exterior de polietileno. Acabados de carcasa y brazos: blanco, negro, verde y cromo con varilla y base negras o full iconic red.**





FLOOR **TOPO**

STILNOVO 2023/24

1. Topo



Included bulb
Classic A Retrofit
LED Bulb E27 7W

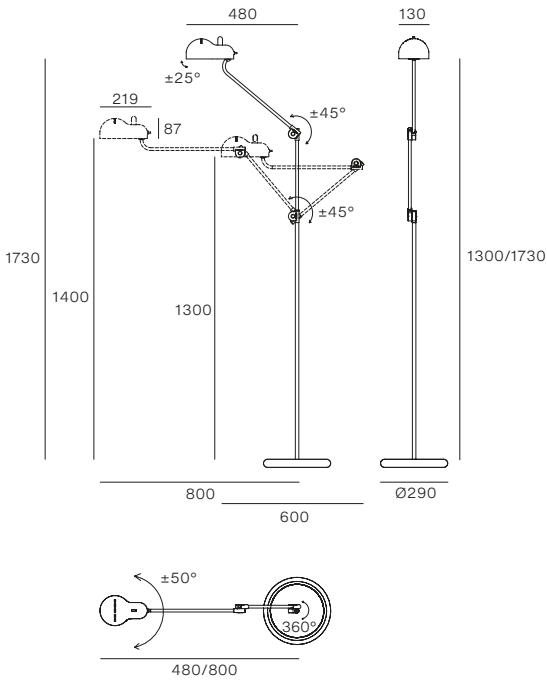

MOD	CODE	FINISH	SOURCE	INPUT	DIMMING	CCT (K)	LUMEN	CRI	IP	OPTICS
1	9081	WH BB	1xE27 7W	220-240V	No	2700	806	≥80	20	Diffused
	9082	BB BB	1xE27 7W	220-240V	No	2700	806	≥80	20	Diffused
	9083	RI RI	1xE27 7W	220-240V	No	2700	806	≥80	20	Diffused
	9084	GR BB	1xE27 7W	220-240V	No	2700	806	≥80	20	Diffused
	9085	CH BB	1xE27 7W	220-240V	No	2700	806	≥80	20	Diffused

Other versions: table, p. 80.

Triedro

1970

Joe Colombo

The Triedro floor lamp is reminiscent of lighting from a photo shoot. Thanks to the contoured and bent metal lampshade, comprised of three parts, the light from the silver-domed LED bulb reflects without glare. A vast flexibility of movement is guaranteed by the supporting double joint, which allows the light source to rotate, incline and slide along the steel stem secured to the solid, circular base.

• **Lampshade, body, bulb holder and rod in metal. Metal base with polyethylene finish. Finish: white/black/chrome.**

Le lampadaire Triedro évoque les lampes de scène des décors photographiques. Grâce à l'abat-jour métallique façonné, plié en trois parties, il reflète la lumière de l'ampoule LED à calotte argentée sans éblouir. Une grande flexibilité de mouvement est garantie par la double articulation principale, qui permet à la source lumineuse de tourner, de s'incliner et de glisser le long de la tige en acier liée à la solide base circulaire.

• **Abat-jour, corps, support de lampe et tige en métal. Base en métal avec finition en polyéthylène. Finitions : blanc/noir/chrome.**

Triedro tierra recrea las lámparas de escenario de los sets de fotografía. Gracias a la pantalla de metal conformado y doblado en tres partes, refleja la luz de la bombilla LED de cúpula plateada sin producir deslumbramientos. El brazo de sujeción de doble articulación garantiza una amplia flexibilidad de movimiento, que permite que la fuente gire, se incline y se deslice a lo largo del vástago de acero unido a la sólida base circular.

• **Pantalla, cuerpo, portalámparas y varilla en metal. Base de metal con acabado en polietileno. Acabado: blanco/negro/cromo.**





FLOOR TRIEDRO

STILNOVO 2023/24



**BIG
MONTHLY
PLANNER**

FLOOR TRIEDRO
STILNOVO 2023/24



1. Tredro



Included bulb
Classic A Mirror
LED Bulb E27 7W

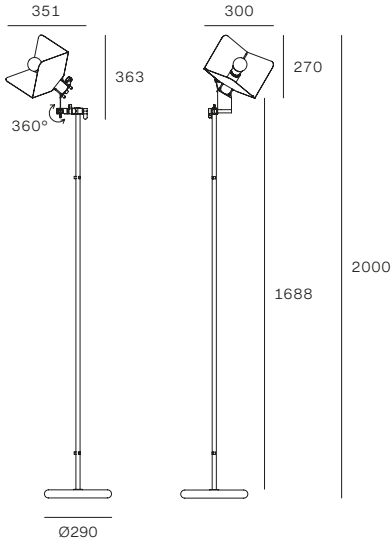

MOD	CODE	FINISH	SOURCE	INPUT	DIMMING	CCT (K)	LUMEN	CRI	IP	OPTICS
1	8994	WH BB	1xE27 7W	220-240V	No	2700	650	≥80	20	Diffused

Other versions: suspension, p. 256; wall/ceiling, p. 356.

Suspension

Suspension

Suspensión

Table
Table
Mesa

14

Floor
Sol
Tierra

92

Wall/ceiling
Mur/plafond
Pared/techo

264

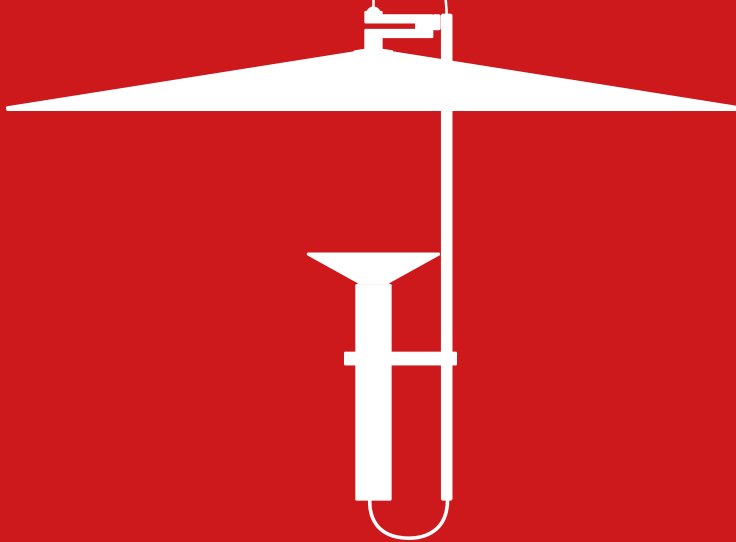

Bascula	146
Campana	152
Demí	158
Diphy	164
Galassia	170
Honey	178
La Mariée	182
Lampiatta	186
Luna	190
Megafono	194
Mongolfier	200
Mr Magoo	204
Opti - line	208
Oxygen	212
Quad	218
Reflexio	224
Saliscendi	228
Saturn	236
Sputnik	240
Tablet	246
Trepiù	250
Triedro	256
Xilema	260

Bascula

1985

Shigeaki Asahara

Freely inspired by the starship Enterprise from Star Trek, Bascula is one of the first lamps to feature a slim disc suspended from a single cable. The conical counterweight balances the disc, keeping the lamp in a horizontal or slanted position, and also directs the light emission.

• **Glass diffuser, aluminium heat sink, metal counterweight. Finishes: white-painted bronze, grey-bronze, bronze-bronze, white-brushed nickel, grey-brushed nickel, red-brushed black nickel.**

Librement inspiré du vaisseau Enterprise de la série télévisée Star Trek, Bascula est l'un des premiers exemples de lampe à disque mince équilibrée sur un seul câble de support. Le contre-poids conique permet d'équilibrer le disque, de maintenir la lampe en position horizontale ou inclinée et de diriger l'émission de lumière.

• **Diffuseur en verre, dissipateur en aluminium, contrepoids en métal. Finitions : blanc-bronze peint, gris-bronze peint, bronze brossé, blanc-nickel peint, gris-nickel peint, rouge-nickel noir brossé.**

Inspirada libremente en la nave espacial Enterprise de la serie televisiva Star Trek, Bascula es uno de los primeros ejemplos de lámpara de disco delgado en equilibrio sobre un único cable de soporte. El contrapeso cónico permite equilibrar el plato, manteniendo la lámpara en posición horizontal o inclinada y orientando a su vez también la emisión luminosa.

• **Difusor de vidrio, disipador en aluminio, contrapeso en metal. Acabados: blanco-bronze pintado, gris-bronze pintado, bronce cepillado, blanco-níquel pintado, gris-níquel pintado, rojo-níquel negro cepillado.**







SUSPENSION **BASCULA**

STILNOVO 2023/24



SUSPENSION **BASCULA**

STILNOVO 2023/24



1. Bascula



Dimming kits

 **KIT0079 / CASAMBI**
DALI / 1 art / out

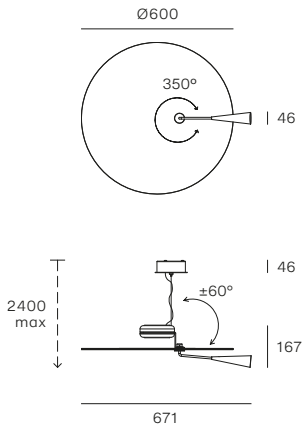

MOD	CODE	FINISH	SOURCE	INPUT	DIMMING	CCT (K)	LUMEN	CRI	IP	OPTICS
1	CZ001CBZMDD	BZ BZ	TopLED 26W	220-240V	DALI Push	2700	3547	90	20	Diffused
	CZ001CBZWDD	BZ BZ	TopLED 26W	220-240V	DALI Push	3000	3795	90	20	Diffused
	CZ001CGGMDD	GG BZ	TopLED 26W	220-240V	DALI Push	2700	3547	90	20	Diffused
	CZ001CGGWDD	GG BZ	TopLED 26W	220-240V	DALI Push	3000	3795	90	20	Diffused
	CZ001CRRMDD	RR HK	TopLED 26W	220-240V	DALI Push	2700	3547	90	20	Diffused
	CZ001CRRWDD	RR HK	TopLED 26W	220-240V	DALI Push	3000	3795	90	20	Diffused
	CZ001CWHMDD	WH BZ	TopLED 26W	220-240V	DALI Push	2700	3547	90	20	Diffused
	CZ001CWHWDD	WH BZ	TopLED 26W	220-240V	DALI Push	3000	3795	90	20	Diffused
	CZ001CKGMDD	GG NK	TopLED 26W	220-240V	DALI Push	2700	3547	90	20	Diffused
	CZ001CKGWDD	GG NK	TopLED 26W	220-240V	DALI Push	3000	3795	90	20	Diffused
	CZ001CKWMDD	WH NK	TopLED 26W	220-240V	DALI Push	2700	3547	90	20	Diffused
	CZ001CKWWDD	WH NK	TopLED 26W	220-240V	DALI Push	3000	3795	90	20	Diffused

Campana

1969

Stilnovo

Dating back to 1969, the Campana recalls the Pop style that is still trendy today.

The new LED light source integrated into the large flared lampshade illuminates the underlying environment whilst creating a characteristic luminous corolla that slides across the external surface of the lamp.

• **Aluminium body and lampshade, metal wire casing.**
Finishes: grey-white, red, grey-white/brushed aluminium.

Campana, depuis 1969, est une réminiscence du style pop qui est toujours d'actualité. La nouvelle source LED intégrée dans le grand abat-jour évasé illumine la pièce en dessous et, en même temps, crée une corolle lumineuse caractéristique qui glisse sur la surface extérieure de la lampe.

• **Coque et abat-jour en aluminium, pavillon en métal.**
Finitions : grey white, rouge, grey white/aluminium brossé.

Desde 1969, Campana retoma el estilo pop que sigue vigente en la actualidad. La nueva fuente LED integrada en la gran pantalla acampanada ilumina el espacio inferior y, al mismo tiempo, crea una característica corola luminosa que se desliza sobre la superficie externa de la lámpara.

• **Carcasa y pantalla en aluminio, cubierta de cable en metal.** **Acabados: grey white, rojo, grey white/aluminio cepillado.**











1. Campana Ø64



Dimming kits

KIT0079 / CASAMBI
DALI / 1 art / out

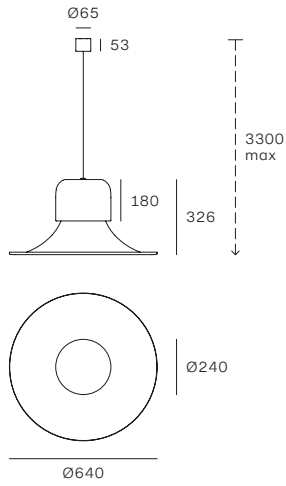

SUSPENSION CAMPANA

MOD	CODE	FINISH	SOURCE	INPUT	DIMMING	CCT (K)	LUMEN	CRI	IP	OPTICS
1	9300	LY LY	TopLED 31W	220-240V	DALI Push	2700	3234	90	20	Diffused
	9301	RR RR	TopLED 31W	220-240V	DALI Push	2700	3234	90	20	Diffused
	9302	LY HA	TopLED 31W	220-240V	DALI Push	2700	3234	90	20	Diffused

STILNOVO 2023/24

Demí

2019

Mirco Crosatto

When switched off, Demí is a large, transparent dome. When switched on, the lower edge and the thousands of laser micro-incisions on the surface emit soft and uniform light thanks to the exclusive Opti-Light™ technology. The light is generated by an invisible LED bulb inside the ring of the large upper opening that, like in Rome's ancient Pantheon, is the source of light.

• **Heat-blown PMMA diffuser, aluminium ring, metal wire casing. Finish: white/transparent.**

Demí, lorsqu'il est éteint, est une grande coupole transparente. Grâce à la technologie exclusive Opti-Light™, lorsqu'il est allumé, le bord inférieur et les milliers de micro-incisions laser de la surface diffusent une lumière douce et homogène. Celle-ci est générée par une source LED invisible située dans l'anneau du grand trou supérieur qui, comme dans l'ancien Panthéon, est la source de lumière.

• **Diffuseur en PMMA soufflé à chaud, anneau en aluminium, pavillon en métal. Finition : blanc/transparent.**

Cuando está apagada, Demí es una gran cúpula transparente. Gracias a la exclusiva tecnología Opti-Light™, cuando se enciende, el borde inferior y los miles de micrograbados láser de la superficie difunden una iluminación suave y homogénea. Es generada por una fuente LED invisible situada en el anillo del gran orificio superior que, como sucede en el antiguo Panteón, es el origen de la luz.

• **Difusor en PMMA termosoplado, anillo de aluminio, cubierta de cable en metal. Acabado: blanco/transparente.**







SUSPENSION **DEMÍ**

STILNOVO 2023/24



SUSPENSION **DEMI**

STILNOVO 2023/24



Diphy

2016

Mirco Crosatto

Diphy is a collection of luminous and transparent petals, combining natural aesthetics with a technological soul. The central source transmits light to the curving edges whilst the micro-incisions of the surfaces create soft and uniform ambient lighting. OptiLight™ technology allows Diphy to disappear from view when switched off, only to magically reappear when switched on.

• **Thermocurved PMMA diffuser, central body in aluminium, metal wire casing. Finish: white/transparent.**

Diphy est une collection de pétales lumineux et transparents qui combine une esthétique organique avec une âme technologique. La source centrale transmet la lumière aux bords sinueux et aux micro-incisions des surfaces, créant ainsi un éclairage d'ambiance doux et homogène. La technologie OptiLight™ permet à Diphy de disparaître de la vue lorsqu'il est éteint et de réapparaître comme par magie lorsqu'il est allumé.

• **Diffuseur en PMMA plié à chaud, corps central en aluminium, pavillon en métal. Finition : blanc/transparent.**

Diphy de tierra es un pétalo brillante y transparente, que combina la estética orgánica con un espíritu tecnológico. La fuente de luz, suspendida sobre un gran tallo curvo, transmite al encenderse la luz hacia los bordes sinuosos y las microincisiones de la superficie, generando una iluminación ambiental suave y homogénea. La tecnología OptiLight™ permite que Diphy desaparezca de la vista cuando se apaga, reapareciendo mágicamente cuando se enciende.

• **Difusor en PMMA termocurvado, cuerpo central en aluminio, cubierta de cable en metal. Acabado: blanco/transparente.**





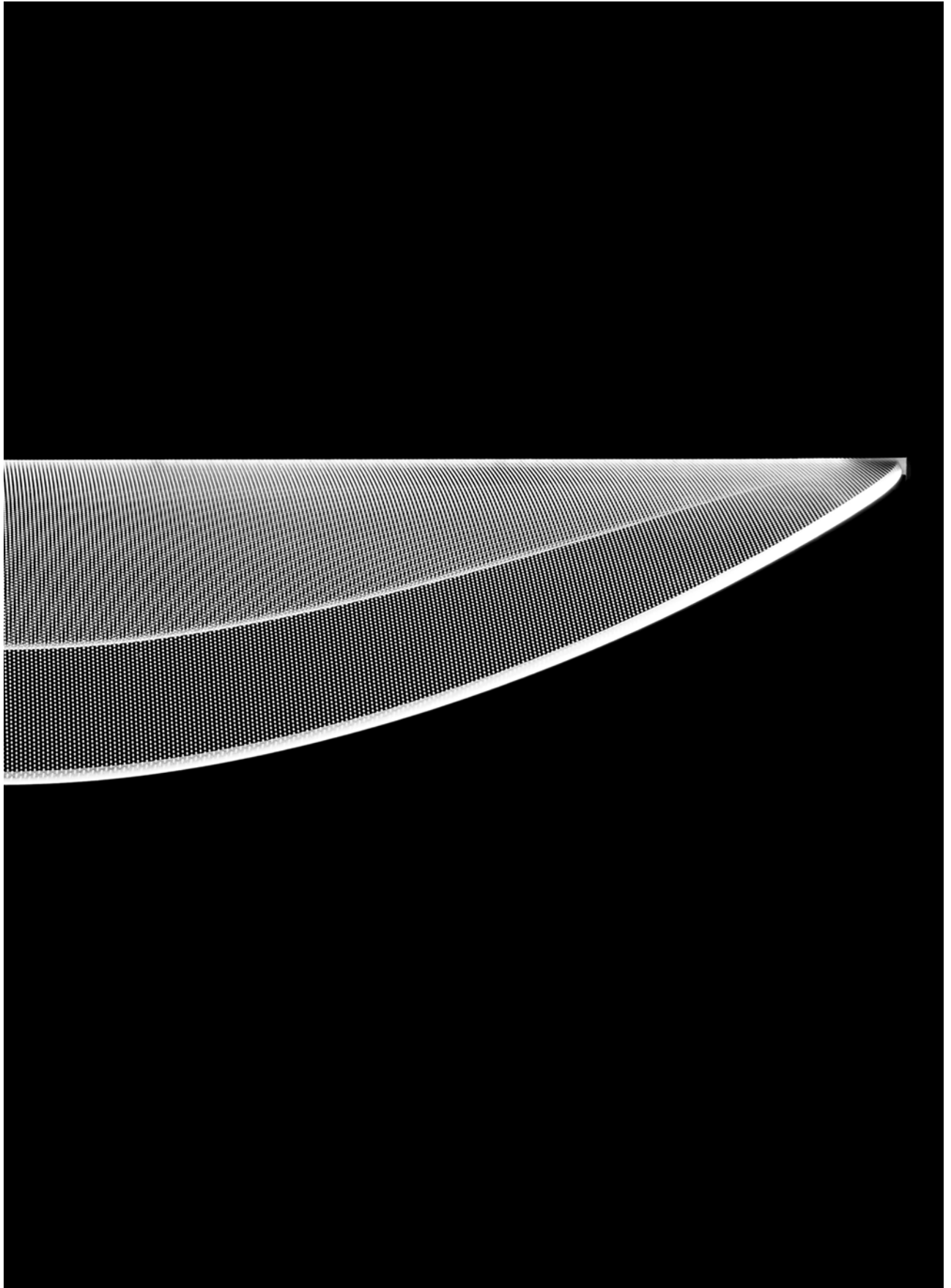



1. Diphy L54

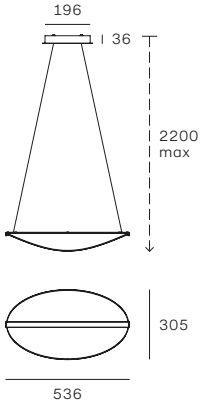

Dimming kits

- KIT0079** / CASAMBI
DALI / 1 art / in
- KIT0080** / CASAMBI
PH-CUT / 1-2 art / in
- KIT0026**
PH-CUT / 1-4 art

2. Diphy L76

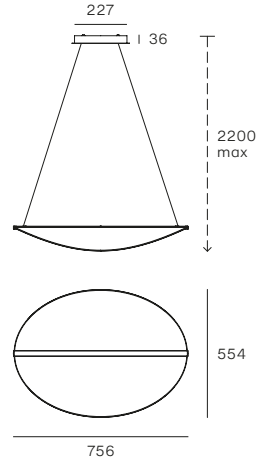

Dimming kits

- KIT0079** / CASAMBI
DALI / 1 art / in
- KIT0080** / CASAMBI
PH-CUT / 1 art / in
- KIT0026**
PH-CUT / 1-2 art

3. Diphy L54 Semi-recessed

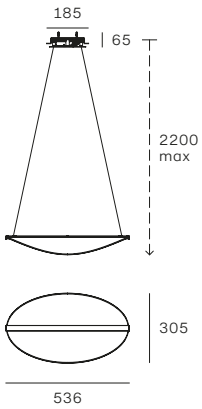

Dimming kits

- KIT0080** / CASAMBI
PH-CUT / 1-2 art / in
- KIT0026**
PH-CUT / 1-4 art



4. Diphy L76 Semi-recessed

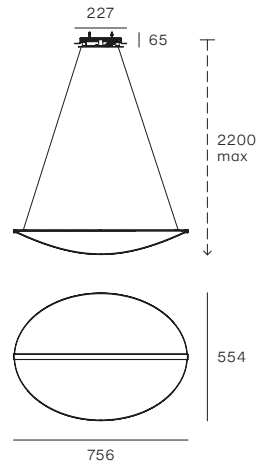

Dimming kits

- KIT0080** / CASAMBI
PH-CUT / 1 art / in
- KIT0026**
PH-CUT / 1-2 art

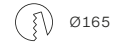

5. Diphy L96

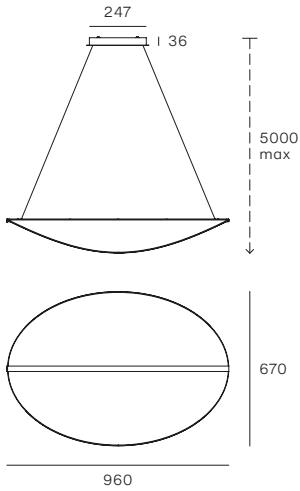

Dimming kits

KIT0079 / CASAMBI
DALI / 1 art / in

6. Diphy 3 sources

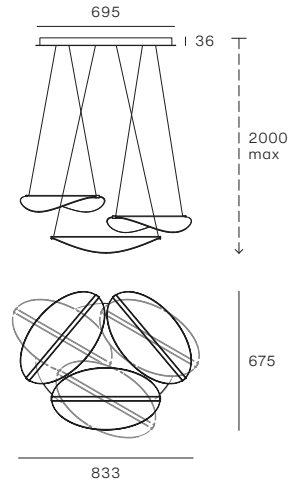

Dimming kits

KIT0079 / CASAMBI
DALI / 1 art / in

MOD	CODE	FINISH	SOURCE	INPUT	DIMMING	CCT (K)	LUMEN	CRI	IP	OPTICS
1	9090	WH TR	TopLED 20W	220-240V	DALI Push	3000	2609	90	20	Diffused
	9090M	WH TR	TopLED 20W	220-240V	DALI Push	2700	2426	90	20	Diffused
	8172	WH TR	TopLED 20W	220-240V	Phase-cut	3000	2609	90	20	Diffused
	8172M	WH TR	TopLED 20W	220-240V	Phase-cut	2700	2426	90	20	Diffused
2	8170	WH TR	TopLED 40W	220-240V	DALI Push	3000	4368	90	20	Diffused
	8170M	WH TR	TopLED 40W	220-240V	DALI Push	2700	4062	90	20	Diffused
	8173	WH TR	TopLED 48W	220-240V	Phase-cut	3000	5011	90	20	Diffused
	8173M	WH TR	TopLED 48W	220-240V	Phase-cut	2700	4660	90	20	Diffused
3	8174	WH TR	TopLED 21W	220-240V	Phase-cut	3000	2609	90	20	Diffused
	8174M	WH TR	TopLED 21W	220-240V	Phase-cut	2700	2426	90	20	Diffused
4	8171	WH TR	TopLED 48W	220-240V	Phase-cut	3000	5011	90	20	Diffused
	8171M	WH TR	TopLED 48W	220-240V	Phase-cut	2700	4660	90	20	Diffused
5	8169	WH TR	TopLED 54W	220-240V	DALI Push	3000	5760	90	20	Diffused
	8169M	WH TR	TopLED 54W	220-240V	DALI Push	2700	5357	90	20	Diffused
6	8168	WH TR	TopLED 54W	220-240V	DALI Push	3000	6582	90	20	Diffused
	8168M	WH TR	TopLED 54W	220-240V	DALI Push	2700	6121	90	20	Diffused

Other versions: floor, p. 98; wall/ceiling, p. 276.

Galassia

1959

Stilnovo

The 1950s charm of the Galassia suspension light, available with six or twelve bulbs, remains unchanged thanks to the combination of the brass with galvanic gilding on the structure and the white triplex blown glass spheres. A priceless collection that enriches the space with a sophisticated retro touch.

• **Interchangeable brass body and rods, triplex glass diffusers, metal wire casing. Finish: brass with galvanic gilding/glossy white glass.**

La suspension Galassia, disponible avec six ou douze lampes, conserve le charme des années 1950 grâce à la combinaison du laiton avec la dorure galvanique de la structure et les sphères en verre soufflé triplex blanc. Une collection précieuse qui enrichit l'espace d'une touche rétro sophistiquée.

• **Corps et tiges interchangeables en laiton, diffuseurs en verre triplex pavillon en métal. Finition : laiton avec dorure galvanique/verre blanc brillant.**

Galassia en suspensión, disponible con seis o doce luces, mantiene inalterado el encanto de los años 50 gracias a la combinación del latón con dorado galvánico de la estructura y las esferas de vidrio soplado triplex blanco. Una atractiva colección que enriquece el espacio con un sofisticado toque retro.

• **Cuerpo y varillas de latón intercambiables, difusores en vidrio triplex, cubierta de cable en metal. Acabado: latón con dorado galvánico/cristal blanco brillante.**





SUSPENSION GALASSIA

STILNOVO 2023/24











1. Galassia 6 sources



Included bulbs
Miniglobo P45
LED Bulb E14 6W

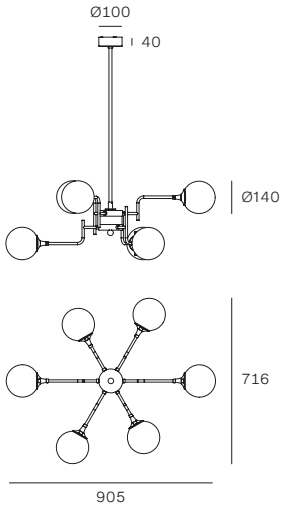

2. Galassia 12 sources



Included bulbs
Miniglobo P45
LED Bulb E14 6W

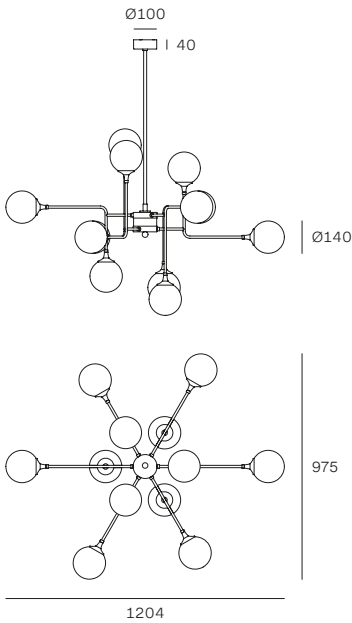

*2 stems included

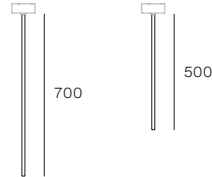

MOD	CODE	FINISH	SOURCE	INPUT	DIMMING	CCT (K)	LUMEN	CRI	IP	OPTICS
1	9556	AU WH	6xE14 6W	220-240V	No	2700	4836	≥80	20	Diffused
2	9555	AU WH	12xE14 6W	220-240V	No	2700	9672	≥80	20	Diffused

Other versions: floor, p. 104; wall/ceiling, p. 288.

Honey

2019

Pio & Tito Toso

The Honey collection plays on the repetition of a modular element which multiplies to create linear or circular configurations. The warm light is diffused both directly and indirectly and, curtained by wavy opaline diffusers, creates fascinating nuances.

• **Modules in polycarbonate, metal wire casing. Finish: glossy white.**

La version murale de Honey joue sur la répétition, créant deux configurations linéaires de trois ou neuf modules. La lumière chaude est diffusée directement et indirectement et, tamisée par des diffuseurs opalins ondulés, donne vie à des nuances fascinantes.

• **Modules en Polycarbonate, pavillon en métal. Finitions blanc-brillant.**

Honey en pared juega con la repetición, creando dos configuraciones lineales de tres o nueve módulos. La luz cálida se difunde tanto directa como indirectamente y, protegida por difusores opalinos ondulados, da vida a tonos fascinantes.

• **Módulos en policarbonato, cubierta de cable en metal. Acabado: blanco brillante.**





La Mariée

2018

Mirco Crosatto

La Mariée is an ethereal sphere in blown glass with elegant pink, gold or smokey grey tones. The slightly oval shape and the hidden light source emit a soft ambient illumination that creates a play of reflections. Alone or as part of an arrangement, La Mariée adds a refined touch to the environment.

• **Blown glass casting diffuser, aluminium inner ring, metal wire casing. Finishes: transparent/white, smoky grey/galvanic black nickel, pink/galvanic rose gold, gold/galvanic gold.**

La Mariée est une sphère éthérée en verre soufflé dans des tons précieux de rose, d'or ou fumée. Sa forme légèrement ovale et sa source lumineuse invisible créent une lumière d'ambiance douce animée de reflets. Seule ou dans une composition, La Mariée apporte une touche d'élégance à la pièce.

• **Diffuseur en pâte de verre soufflé, anneau interne en aluminium, pavillon en métal. Finitions : transparent/blanc, fumé/galvanisé nickel noir, rose/galvanisé or rose, or/galvanisé or.**

La Mariée es una etérea esfera de vidrio soplado con preciosos tonos rosa, oro o ahumados. La forma ligeramente ovalada y la fuente invisible difunden una luz ambiental suave que juega con los reflejos. Sola o en composición, La Mariée agrega un toque refinado a los espacios.

• **Difusor en vidrio en pasta soplado, anillo interno en aluminio, cubierta de cable en metal. Acabados: transparente/blanco, ahumado/níquel negro galvanizado, rosa/oro rosa galvanizado/oro galvanizado.**







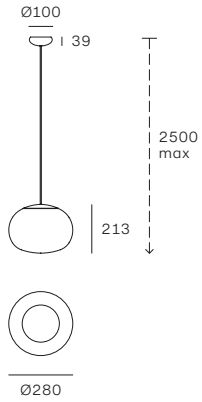

1. La Mariée



Dimming kits

-  **KIT0080** / CASAMBI
PH-CUT / 1-5 art / out
-  **KIT0026**
PH-CUT / 1-11 art



MOD	CODE	FINISH	SOURCE	INPUT	DIMMING	CCT (K)	LUMEN	CRI	IP	OPTICS
1	8624	WH AU	TopLED 9W	220-240V	Phase-cut	3000	1082	90	20	Diffused
	8625	WH TR	TopLED 9W	220-240V	Phase-cut	3000	1082	90	20	Diffused
	8626	BB SG	TopLED 9W	220-240V	Phase-cut	3000	1082	90	20	Diffused
	8627	WH RG	TopLED 9W	220-240V	Phase-cut	3000	1082	90	20	Diffused

Other versions: table, p. 46.

Lampiatta

1971

**Jonathan De Pas
Donato D'Urbino
Paolo Lomazzi**

Lampiatta is the essence of suspension. The mechanical parts of this lamp have been reduced to a minimum, assembled without the use of joints or mechanisms. The two sizes and five colours available give life to combinations that are always innovative and vivacious.

● **Parabolic diffuser in aluminium, bulb holder in plastic material, metal wire casing. Finishes: white/white, black/white, yellow/white, red/white, green/white.**

Lampiatta est l'essence même de la suspension. Il s'agit d'une lampe dont les composants mécaniques sont réduits au minimum, assemblés sans nœuds ni mécanismes. Les deux tailles et les cinq couleurs disponibles donnent vie à des combinaisons toujours nouvelles et vivaces.

● **Parabole en aluminium, support de lampe en plastique, pavillon en métal. Finitions : blanc/blanc, noir/blanc, jaune/blanc, rouge/blanc, vert/blanc.**

Lampiatta es la esencia de la suspensión. Es una lámpara de componentes mecánicos reducidos al mínimo, ensamblada sin el uso de juntas ni mecanismos. Los dos tamaños y cinco colores disponibles dan vida a combinaciones siempre nuevas y vivas.

● **Parábola en aluminio, portalámparas en material plástico, cubierta de cable en metal. Acabados: blanco/blanco, negro/blanco, amarillo/blanco, rojo/blanco, verde/blanco.**







1. Lampiatta Ø28

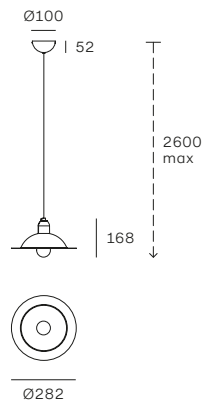

Included bulb
Classic A Retrofit
LED Bulb E27 7W

2. Lampiatta Ø50

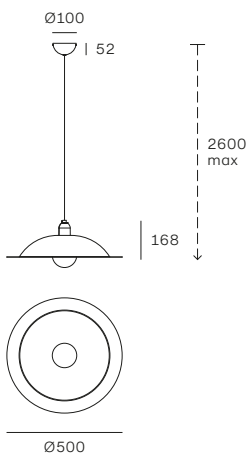

Included bulb
Classic Globe
LED Bulb E27 11W

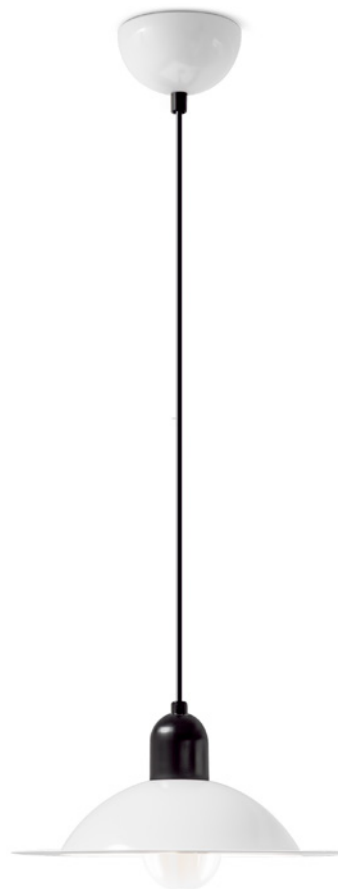

MOD	CODE	FINISH	SOURCE	INPUT	DIMMING	CCT (K)	LUMEN	CRI	IP	OPTICS
1	8983	WH WH	1xE27 7W	220-240V	No	2700	806	≥80	20	Diffused
	8984	BB WH	1xE27 7W	220-240V	No	2700	806	≥80	20	Diffused
	8985	RV WH	1xE27 7W	220-240V	No	2700	806	≥80	20	Diffused
	8981	YY WH	1xE27 7W	220-240V	No	2700	806	≥80	20	Diffused
	8982	GR WH	1xE27 7W	220-240V	No	2700	806	≥80	20	Diffused
	2	8987	WH WH	1xE27 11W	220-240V	No	2700	1520	≥80	20
8988		BB WH	1xE27 11W	220-240V	No	2700	1520	≥80	20	Diffused
8989		RV WH	1xE27 11W	220-240V	No	2700	1520	≥80	20	Diffused
8990		YY WH	1xE27 11W	220-240V	No	2700	1520	≥80	20	Diffused
8991		GR WH	1xE27 11W	220-240V	No	2700	1520	≥80	20	Diffused

Other versions: on table, p. 54, or wall-mounted, p. 316.

Luna

2023

Shigeaki Asahara

A sleek, lightweight suspension lamp with minimalist proportions and soft light emission. The light is projected onto a directional reflective disc, which in turn directs it comfortably onto the surface. A patented jointed balancing system allows easy adjustment of the angle of the disc and therefore the light beam.

• **Disc and lamp body in aluminium. Finishes: white-chrome, black-gold.**

Une suspension subtile et légère aux proportions minimalistes et à l'émission douce. La lumière est projetée sur un disque réflecteur pivotant, qui la diffuse à son tour sur le plan de manière confortable. Un système breveté d'équilibrage des pivots permet de régler facilement l'inclinaison du disque et donc la projection de la lumière.

• **Disque et corps de lampe en aluminium. Finitions : blanc-chrome, noir-or.**

Una suspensión fina y ligera, de proporciones mínimas y con una emisión suave. La luz se proyecta sobre un disco reflectante orientable, que a su vez la difunde confortablemente sobre el plano. Un sistema de equilibrio de articulación patentado permite orientar fácilmente la inclinación del disco y, en consecuencia, la proyección de la luz.

• **Disco y cuerpo de lámpara en aluminio. Acabados: blanco-cromo, negro-oro.**







1. Luna



Dimming kits

KIT0079 / CASAMBI
DALI / 1 art / out

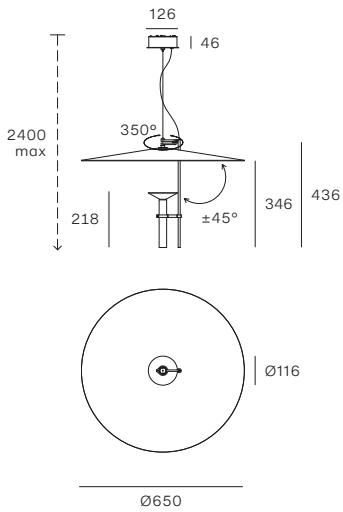

MOD	CODE	FINISH	SOURCE	INPUT	DIMMING	CCT (K)	LUMEN	CRI	IP	OPTICS
1	9703	WH CH	TopLED 25W	220-240V	Dali Push	3000	3015	90	20	Diffused
	9703M	WH CH	TopLED 25W	220-240V	Dali Push	2700	2804	90	20	Diffused
	9705	BB AU	TopLED 25W	220-240V	Dali Push	3000	3015	90	20	Diffused
	9705M	BB AU	TopLED 25W	220-240V	Dali Push	2700	2804	90	20	Diffused

Other versions: floor, p. 112.

Megafono

1958

Stilnovo

Megafono is an iconic 1950s lamp with both direct and indirect light. In the suspension version with three, six or eight arms, a prized brass structure bearing galvanic gilding combines with the directable double-cone lampshades in ivory or glossy black, illuminating the environment with elegance.

• **Body, suspension rod and wire casing in brass, metal lampshades. Finishes: brass with galvanic gilding, black or ivory lampshades.**

Megafono est une lampe emblématique des années 1950 avec une lumière directe et indirecte. Dans la version à suspension à trois, six ou huit bras, elle associe une précieuse structure en laiton avec dorure galvanique à des à double cône orientable en ivoire ou noir brillant, éclairant la pièce avec élégance.

• **Corps, tige de suspension et pavillon en laiton, abat-jour en métal. Finitions : laiton avec dorure galvanique, abat-jour noir ou bien ivoire.**

Megafono es una icónica lámpara de los años 50 con luz directa e indirecta. En la versión de suspensión de tres, seis u ocho brazos, combina la atractiva estructura de latón con dorado galvánico junto con las pantallas orientables de doble cono en acabado marfil o negro brillante, iluminando el espacio con toda elegancia.

• **Cuerpo, varilla de suspensión y cubierta de cable en latón, pantallas de metal. Acabados: latón con dorado galvánico, pantallas en negro o marfil.**











SUSPENSION **MEGAFONO**

STILNOVO 2023/24

1. Megafono 3x2 sources

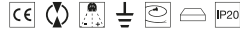

Included bulbs
Miniglobo P45
LED Bulb E14 6W

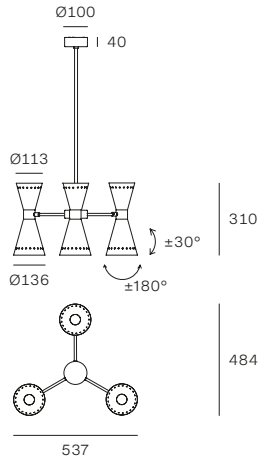

938 (with longer stem)*

2. Megafono 6x2 sources

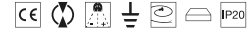

Included bulbs
Miniglobo P45
LED Bulb E14 6W

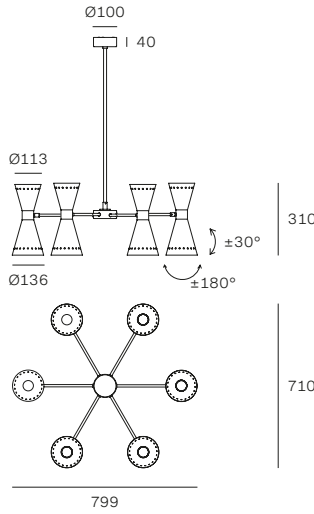

938 (with longer stem)*

3. Megafono 8x2 sources

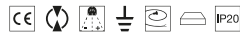

Included bulbs
Miniglobo P45
LED Bulb E14 6W

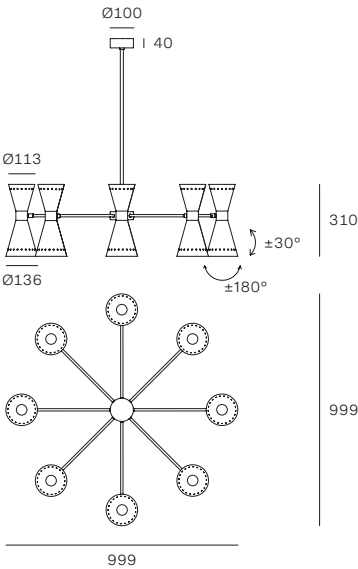

938 (with longer stem)*

*2 stems included

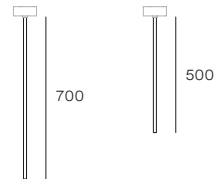

MOD	CODE	FINISH	SOURCE	INPUT	DIMMING	CCT (K)	LUMEN	CRI	IP	OPTICS
1	9576	AU BB	6xE14 6W	220-240V	No	2700	4836	≥80	20	Diffused
	9577	AU IV	6xE14 6W	220-240V	No	2700	4836	≥80	20	Diffused
2	9568	AU BB	12xE14 6W	220-240V	No	2700	9672	≥80	20	Diffused
	9569	AU IV	12xE14 6W	220-240V	No	2700	9672	≥80	20	Diffused
3	9566	AU BB	16xE14 6W	220-240V	No	2700	12896	≥80	20	Diffused
	9567	AU IV	16xE14 6W	220-240V	No	2700	12896	≥80	20	Diffused

Other versions: table, p. 58; wall/ceiling, p. 320.

Mongolfier

2016

Stilnovo

The weightless volumes of the Mongolfier embrace and intercept the light, creating elegant plays of reflection and shadow.

The Warm Tune™ technology allows you to modify the atmosphere – as the light is dimmed, the radiance becomes increasingly warmer and more subdued until reaching a candle-like effect.

• **Body and wire casing in metal. Finishes: black, galvanic pink gold, black galvanic nickel.**

Les volumes légers de Mongolfier enveloppent et interceptent la lumière, créant de précieux jeux de reflets et d'ombres. La technologie Warm Tune™ permet de modifier l'atmosphère : à mesure que l'intensité diminue, la lumière devient progressivement plus chaude et plus douce, jusqu'à atteindre l'effet d'une bougie.

• **Corps et pavillon en métal. Finitions : noir, galvanisé or rose, galvanisé nickel noir.**

Los volúmenes de luz de Mongolfier envuelven e interceptan la luz, creando atractivos juegos de reflejos y sombras. La tecnología Warm Tune™ permite cambiar la atmósfera: a medida que disminuye la intensidad, la luz se vuelve cada vez más cálida y difusa, hasta alcanzar el efecto de una vela.

• **Cuerpo y cubierta de cable en metal. Acabados: negro, galvanizado oro rosa, galvanizado níquel negro.**







1. Mongolfier Ø26

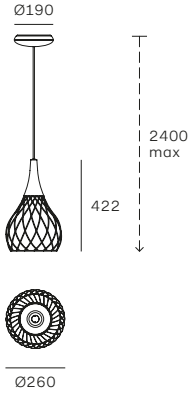

Dimming kits

- KIT0080** / CASAMBI
PH-CUT / 1-3 art / out
- KIT0026**
PH-CUT / 1-6 art

2. Mongolfier Ø40

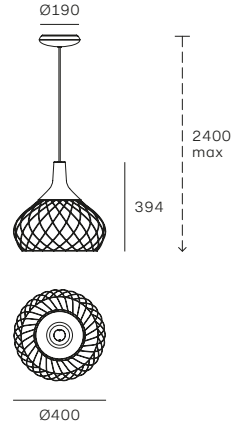

Dimming kits

- KIT0080** / CASAMBI
PH-CUT / 1-3 art / out
- KIT0026**
PH-CUT / 1-6 art

3. Mongolfier Ø57

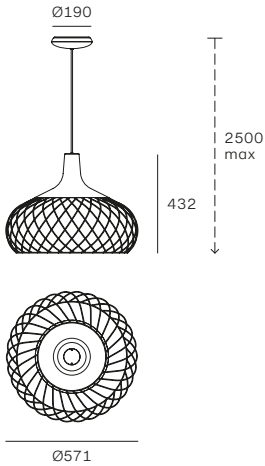

Dimming kits

- KIT0080** / CASAMBI
PH-CUT / 1 art / out
- KIT0026**
PH-CUT / 1-6 art

Warm tune

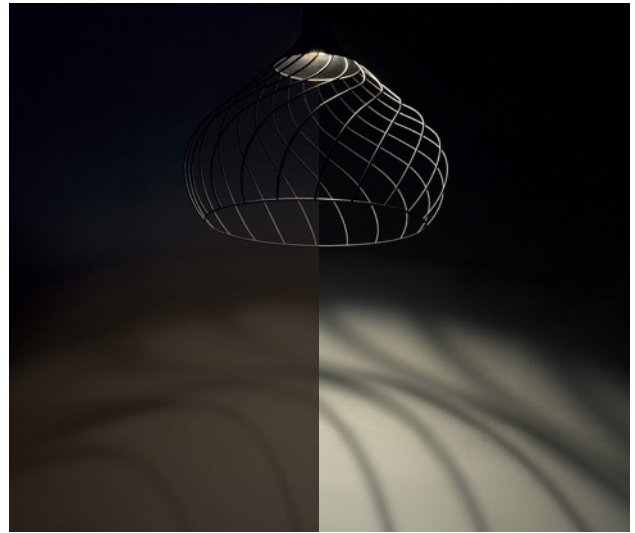

1800K

3000K

MOD	CODE	FINISH	SOURCE	INPUT	DIMMING	CCT	LUMEN	CRI	IP	OPTICS
1	8140	BB	ArrayLED 16W	220-240V	Phase-cut	1800-3000	1012	90	20	Diffused
	8141	RG	ArrayLED 16W	220-240V	Phase-cut	1800-3000	1012	90	20	Diffused
	8142	BC	ArrayLED 16W	220-240V	Phase-cut	1800-3000	1012	90	20	Diffused
2	8144	BB	ArrayLED 16W	220-240V	Phase-cut	1800-3000	1012	90	20	Diffused
	8145	RG	ArrayLED 16W	220-240V	Phase-cut	1800-3000	1012	90	20	Diffused
	8146	BC	ArrayLED 16W	220-240V	Phase-cut	1800-3000	1012	90	20	Diffused
3	8147	BB	ArrayLED 28W	220-240V	Phase-cut	1800-3000	2100	90	20	Diffused
	8148	RG	ArrayLED 28W	220-240V	Phase-cut	1800-3000	2100	90	20	Diffused
	8149	BC	ArrayLED 28W	220-240V	Phase-cut	1800-3000	2100	90	20	Diffused

Mr Magoo

2010

Mirco Crosatto

Mr Magoo is a luminous cloud that adorns and delights with supple and natural lines. The light source is entirely integrated and emits soft and diffused light. Multiple elements allow the creation of an extensive array of scenographies.

• **Polyethylene diffuser, metal wire casing. Finish: white.**

Mr Magoo est un nuage lumineux qui meuble et surprend par ses lignes sinueuses et naturelles. La source est complètement intégrée et émet une lumière douce et diffuse. Plusieurs éléments permettent de créer des scénographies très variées.

• **Diffuseur en polyéthylène, pavillon en métal. Finition : blanc.**

Mr Magoo es una nube luminosa que decora y sorprende con sus líneas sinuosas y naturales. La fuente luminosa está completamente integrada y emite una luz suave y difusa. Diferentes elementos permiten la creación de escenografías de amplio espectro.

• **Difusor en polietileno, cubierta de cable en metal. Acabado: blanco.**

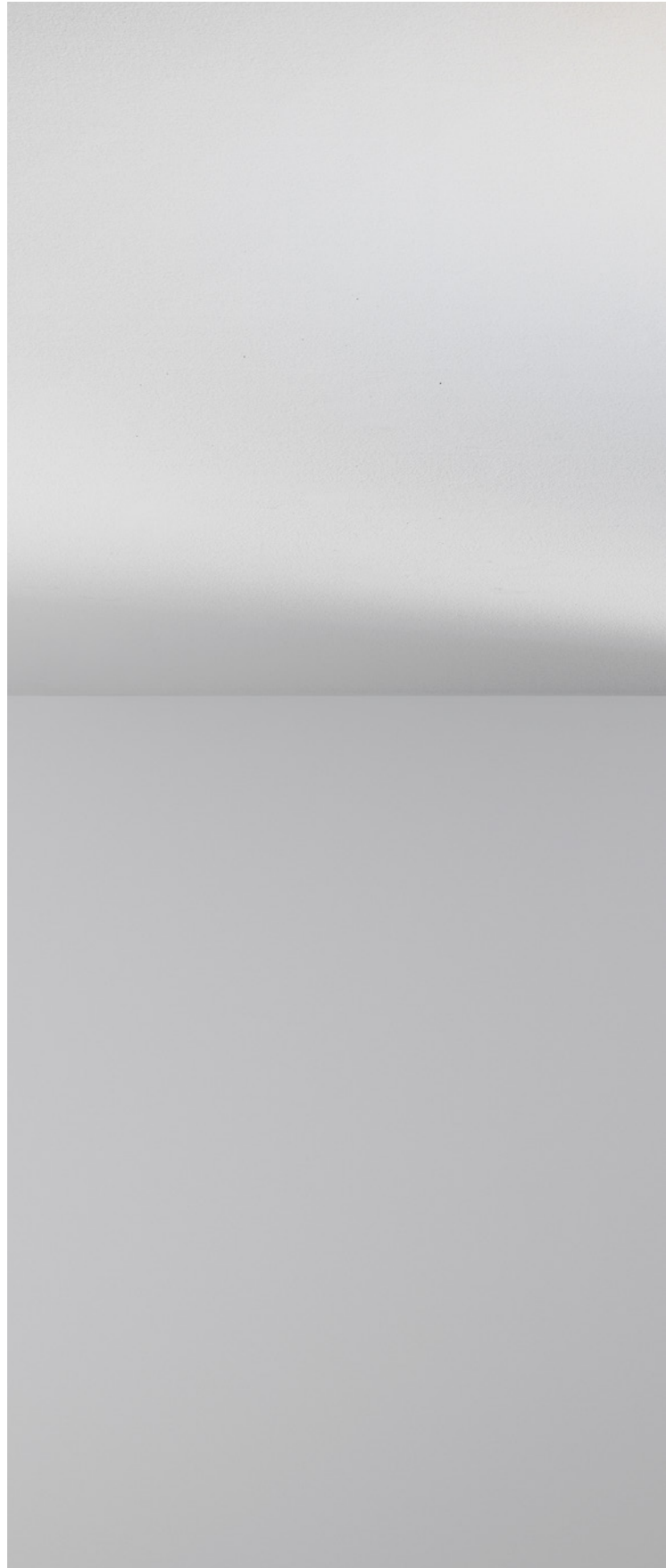





1. Mr Magoo Ø52

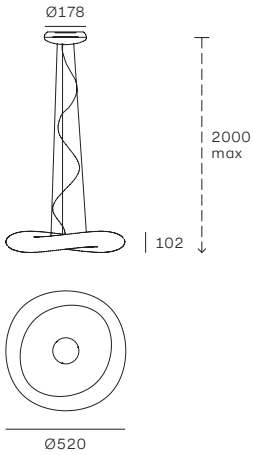

Dimming kits

- KIT0079** / CASAMBI DALI / 1 art / in
- KIT0080** / CASAMBI PH-CUT / 1-2 art / in
- KIT0026** PH-CUT / 1-4 art

2. Mr Magoo Ø75

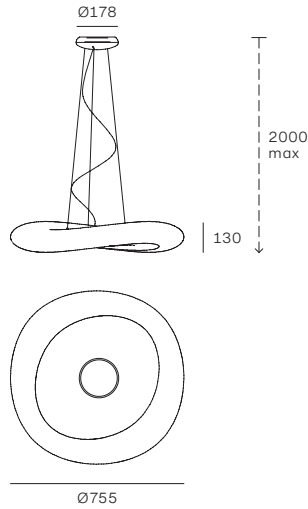

Dimming kits

- KIT0079** / CASAMBI DALI / 1 art / in
- KIT0080** / CASAMBI PH-CUT / 1 art / in
- KIT0026** PH-CUT / 1-3 art

3. Mr Magoo Ø115

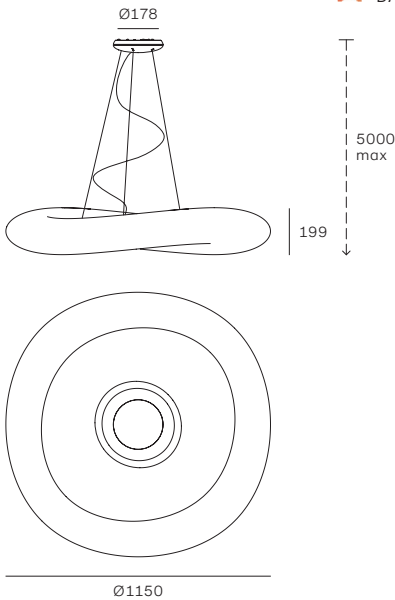

Dimming kits

- KIT0079** / CASAMBI DALI / 1 art / in

MOD	CODE	FINISH	SOURCE (incl.)	INPUT	DIMMING	CCT (K)	LUMEN	CRI	IP	OPTICS
1	7790	WH	1x2GX13 23W	220-240V	No	3000	1900	80	20	Diffused
	8005	WH	TopLED 23W	220-240V	DALI Push	3000	2189	90	20	Diffused
	8135	WH	TopLED 23W	220-240V	Phase-cut	3000	2189	90	20	Diffused
	8005N	WH	TopLED 23W	220-240V	DALI Push	4000	2419	90	20	Diffused
2	8007	WH	TopLED 32W	220-240V	DALI Push	3000	3077	90	20	Diffused
	8137	WH	TopLED 32W	220-240V	Phase-cut	3000	3077	90	20	Diffused
	8007N	WH	TopLED 32W	220-240V	DALI Push	4000	3577	90	20	Diffused
3	7788	WH	TopLED 96W	220-240V	DALI Push	3000	11734	90	20	Diffused
	7788N	WH	TopLED 96W	220-240V	DALI Push	4000	12644	90	20	Diffused

Other versions: floor, p. 116; wall/ceiling, p. 328.

Opti-line

2016

Stilnovo

Opti-Line is comprised of thin, micro-engraved sheeting that uses OptiLight™ technology. Completely transparent when switched off, when switched on, it generates diffused and uniform light emitted from the central body in polished or white painted aluminium.

• **PMMA diffuser, aluminium ring, metal wire casing.**

Finishes: white/transparent, transparent/shiny aluminium.

Opti-Line est composé d'une fine plaque microgravée qui adopte la technologie OptiLight™ : lorsqu'il est éteint, il est complètement transparent, lorsqu'il est allumé, il génère une lumière diffuse et uniforme, provenant du corps central en aluminium poli ou peint en blanc.

• **Diffuseur en PMMA, anneau en aluminium, pavillon en métal. Finitions : blanc/transparent, aluminium brillant/transparent.**

Opti-Line está compuesta por una fina placa micrograbada que adopta la tecnología OptiLight™: cuando está apagada es completamente transparente, cuando se enciende genera una luz difusa y uniforme, proveniente del cuerpo central en aluminio pulido o pintado blanco.

• **Difusor en PMMA, anillo de aluminio, cubierta de cable en metal. Acabados: blanco/transparente, aluminio brillante/transparente.**





Oxygen

2016

Pio & Tito Toso

The familiar design of Oxygen stems from the standard lamp shade, proportioned in all of its forms. It houses the OptiLight™ diffuser, which produces soft and uniform illumination, directed downwards and upwards. The Oxygen collection is both vast and versatile thanks to the various dimensions and finishes.

• **Polyurethane lampshade, PMMA diffuser, metal wire casing. Finishes: white/white, black/white, yellow/white, light blue/white.**

Le design familier d'Oxygen est déterminé par l'archétype de l'abat-jour, proportionné dans toutes ses formes. Il abrite à l'intérieur le diffuseur OptiLight™, qui développe une lumière douce et uniforme, tant vers le bas que vers le haut. Oxygen est une collection étendue et polyvalente grâce à ses différentes tailles et finitions.

• **Abat-jour en polyuréthane, diffuseur en PMMA, pavillon en métal. Finitions : blanc/blanc, noir/blanc, jaune/blanc, bleu/blanc.**

El diseño familiar de Oxygen está determinado por la pantalla arquetípica, proporcionada en todas sus variantes. En su interior alberga el difusor OptiLight™, que desarrolla una luz suave y uniforme, tanto hacia abajo como hacia arriba. Oxygen es una colección extensa y versátil gracias a sus diferentes tamaños y acabados.

• **Pantalla en poliuretano, difusor en PMMA, cubierta de cable en metal. Acabados: blanco/blanco, negro/blanco, amarillo/blanco, azul/blanco.**











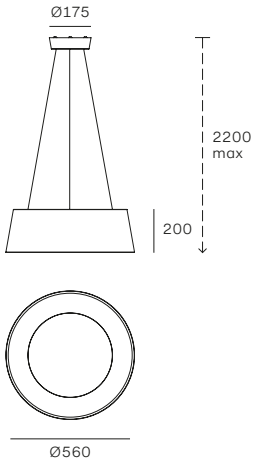

1. Oxygen Ø56



Dimming kits

 **KIT0079** / CASAMBI
DALI / 1 art / in

2. Oxygen Ø75

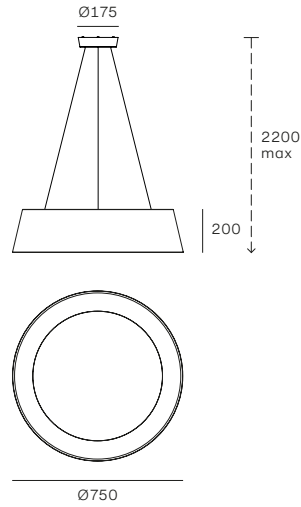

Dimming kits

 **KIT0079** / CASAMBI
DALI / 1 art / in

MOD	CODE	FINISH	SOURCE	INPUT	DIMMING	CCT (K)	LUMEN	CRI	IP	OPTICS
1	8089	WH WH	TopLED 36W	220-240V	DALI Push	3000	3431	90	20	Diffused
	8090	BB WH	TopLED 36W	220-240V	DALI Push	3000	3431	90	20	Diffused
	8091	YY WH	TopLED 36W	220-240V	DALI Push	3000	3431	90	20	Diffused
	8092	AZ WH	TopLED 36W	220-240V	DALI Push	3000	3431	90	20	Diffused
2	8093	WH WH	TopLED 50W	220-240V	DALI Push	3000	4778	90	20	Diffused
	8094	BB WH	TopLED 50W	220-240V	DALI Push	3000	4778	90	20	Diffused
	8095	YY WH	TopLED 50W	220-240V	DALI Push	3000	4778	90	20	Diffused
	8096	AZ WH	TopLED 50W	220-240V	DALI Push	3000	4778	90	20	Diffused

Other versions: floor, p. 120; wall/ceiling, p. 332.

Quad

2014

Pio & Tito Toso

Quad is a collection of pendant lights comprised of an assembly of multiple square modules that emit indirect or dual-emission light that expands softly through the space. The articulated design creates truly evocative atmospheres.

• **Aluminium modules, polycarbonate diffusers, metal wire casing. Finishes: white, black.**

Quad est une collection de lampes à suspension constituée par la connexion de plusieurs modules carrés, qui émettent une lumière indirecte ou à double émission, se diffusant doucement dans l'espace. Avec son design articulé, elle crée des atmosphères suggestives.

• **Modules en aluminium, diffuseurs en polycarbonate, pavillon en métal. Finitions : blanc, noir.**

Quad es una colección de suspensiones compuesta por la conexión de varios módulos cuadrados que emiten una luz indirecta o de doble emisión que se difunde suavemente en los espacios. Gracias a su diseño articulado, crea atmósferas sugerentes.

• **Módulos en aluminio, difusores en policarbonato, cubierta de cable en metal. Acabados: blanco, negro.**









1. Quad 7 modules - monoem.



Dimming kits

KIT0080 / CASAMBI
PH-CUT / 1 art / out

KIT0026
PH-CUT / 1-2 art

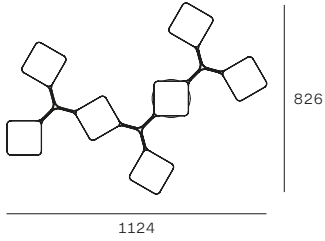

1. Quad 7 modules - biem.

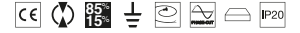

Dimming kits

KIT0080 / CASAMBI
PH-CUT / 1 art / out

KIT0026
PH-CUT / 1-2 art

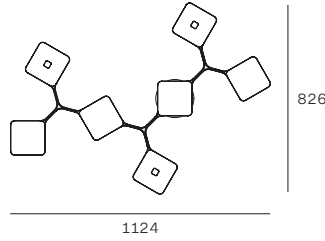

3. Quad 9 modules - monoem.



Dimming kits

KIT0079 / CASAMBI
DALI / 1 art / out

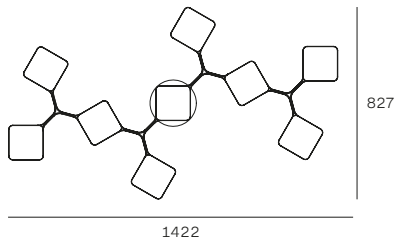
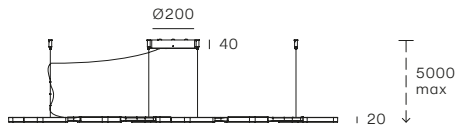

4. Quad 9 modules - biem.



Dimming kits

KIT0079 / CASAMBI
DALI / 1 art / out

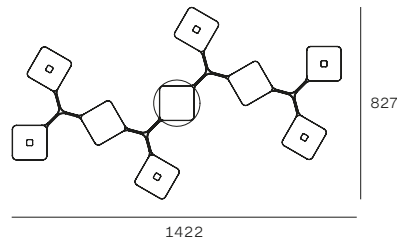
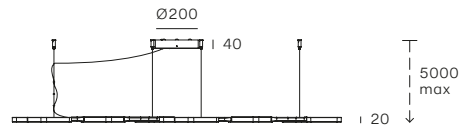

MOD	CODE	FINISH	SOURCE	INPUT	DIMMING	CCT (K)	LUMEN	CRI	IP	OPTICS
1	8520	WH	TopLED 42W	220-240V	Phase-cut	3000	4019	90	20	Diffused
	8521	BB	TopLED 42W	220-240V	Phase-cut	3000	4019	90	20	Diffused
2	8526	WH	TopLED 54W	220-240V	Phase-cut	3000	5001	90	20	Diffused
	8527	BB	TopLED 54W	220-240V	Phase-cut	3000	5001	90	20	Diffused
3	8110	WH	TopLED 91W	220-240V	DALI Push	3000	8676	90	20	Diffused
	8111	BB	TopLED 91W	220-240V	DALI Push	3000	8676	90	20	Diffused
4	8522	WH	TopLED 89W	220-240V	DALI Push	3000	8741	90	20	Diffused
	8523	BB	TopLED 89W	220-240V	DALI Push	3000	8741	90	20	Diffused

5. Quad 12 modules - monoem.



Dimming kits

KIT0079 / CASAMBI
DALI / 1 art / out

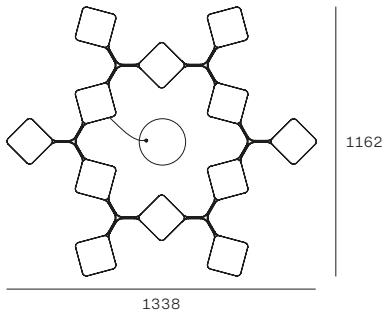
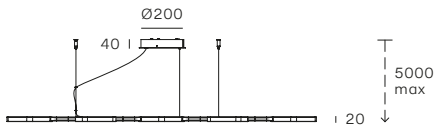

6. Quad 12 modules - biem.



Dimming kits

KIT0079 / CASAMBI
DALI / 1 art / out

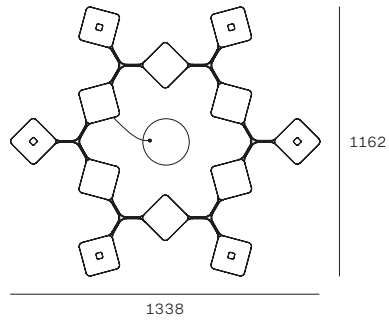
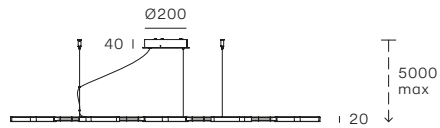

MOD	CODE	FINISH	SOURCE	INPUT	DIMMING	CCT (K)	LUMEN	CRI	IP	OPTICS
5	8112	WH	TopLED 91W	220-240V	DALI Push	3000	8676	90	20	Diffused
	8113	BB	TopLED 91W	220-240V	DALI Push	3000	8676	90	20	Diffused
6	8524	WH	TopLED 90W	220-240V	DALI Push	3000	8741	90	20	Diffused
	8525	BB	TopLED 90W	220-240V	DALI Push	3000	8741	90	20	Diffused

Other versions: wall/ceiling, p. 338.

Reflexio

2018

Mirco Crosatto

Reflexio is a large disc of reflected light in which the exterior light source is entirely invisible. The light beam is uniformly distributed by the dome-shaped reflector, providing soft, indirect, comfortable illumination.

• **Body and wire casing in metal. Finishes: white/white, black/white, chocolate/white.**

Reflexio est un grand disque de lumière réfléchi, dans lequel la source périphérique est totalement invisible. Le faisceau lumineux est uniformément réparti par le réflecteur bombé pour un éclairage indirect, doux et confortable.

• **Corps et pavillon en métal. Finitions : blanc/blanc, noir/blanc, chocolat/blanc.**

Reflexio es un gran disco de luz reflejada, en el que la fuente perimetral es completamente invisible. El haz de luz se distribuye uniformemente por el reflector de cúpula, para una iluminación indirecta, suave y confortable.

• **Cuerpo y cubierta de cable en metal. Acabados: blanco/blanco, negro/blanco, chocolate/blanco.**

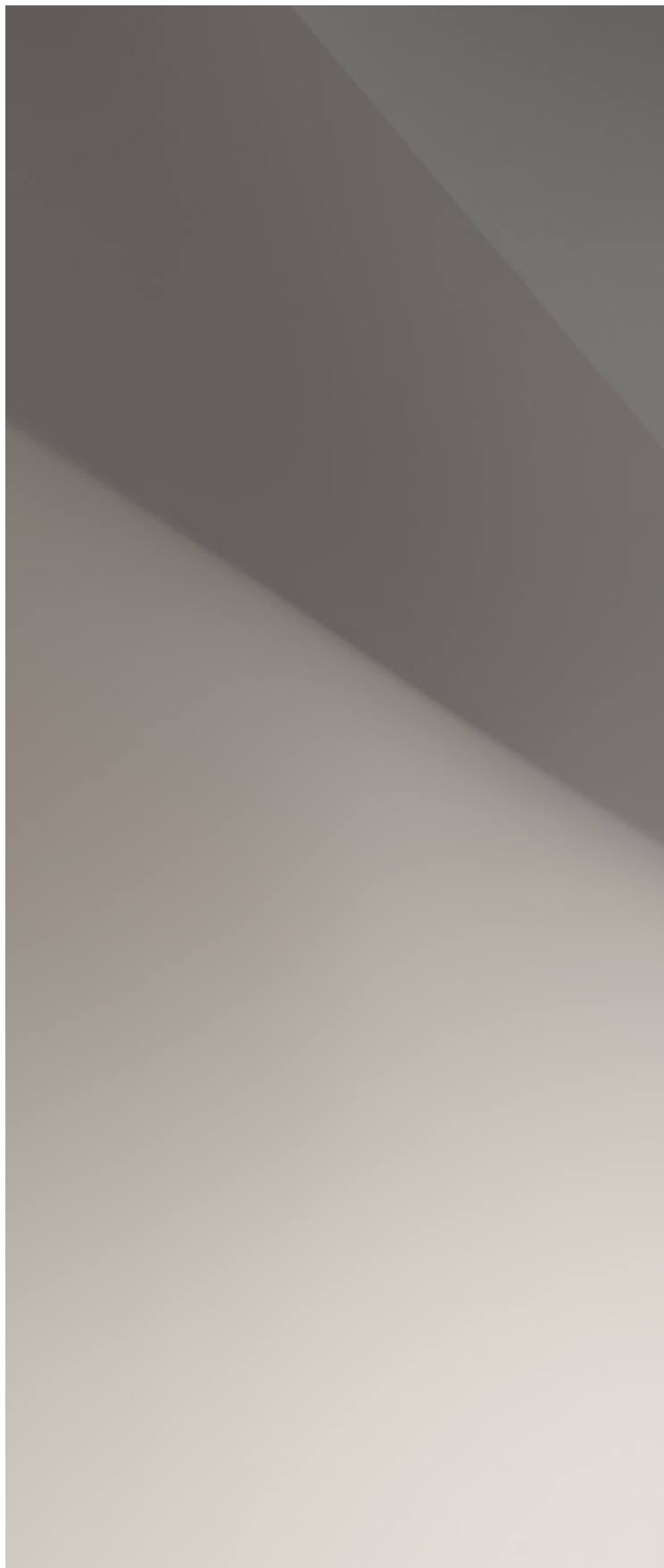





SUSPENSION REFLEXIO

STILNOVO 2023/24

1. Reflexio Ø46

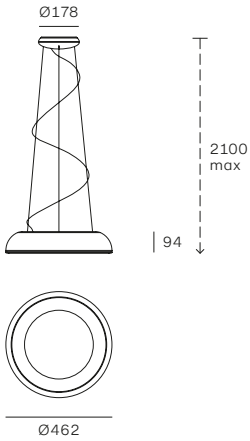

Dimming kits

- KIT0080** / CASAMBI
PH-CUT / 1 art / in
- KIT0026**
PH-CUT / 1-2 art



2. Reflexio Ø65

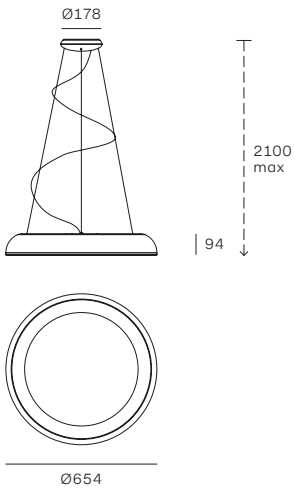

Dimming kits

- KIT0080** / CASAMBI
PH-CUT / 1 art / in
- KIT0026**
PH-CUT / 1-2 art

MOD	CODE	FINISH	SOURCE	INPUT	DIMMING	CCT (K)	LUMEN	CRI	IP	OPTICS
1	8536	WH WH	TopLED 35W	220-240V	Phase-cut	3000	3430	90	20	Diffused
	8537	BB WH	TopLED 35W	220-240V	Phase-cut	3000	3430	90	20	Diffused
	8538	CB WH	TopLED 35W	220-240V	Phase-cut	3000	3430	90	20	Diffused
2	8539	WH WH	TopLED 48W	220-240V	Phase-cut	3000	4778	90	20	Diffused
	8540	BB WH	TopLED 48W	220-240V	Phase-cut	3000	4778	90	20	Diffused
	8541	CB WH	TopLED 48W	220-240V	Phase-cut	3000	4778	90	20	Diffused

Other versions: wall/ceiling, p. 342.

Saliscendi

1957

Achille & Pier Giacomo Castiglioni

Designed in 1957, the next year two unique copies were created for the Milan Chamber of Commerce. Today, the Saliscendi finally emerges as an adjustable dual-emission metal lamp re-engineered with dimmable LED light sources. The luminous body and reflective disc slide silently along the cables, ensuring perfectly modulated lighting. Travelling in the opposite direction, the two elements diffuse more direct or indirect light depending on the distance by which they are separated.

• **Body, parabolic diffuser and wire casing in metal, diffusers in PMMA. Finishes: grey-white/white, ruby red/white, grass green/white.**

Saliscendi est une lampe réglable en métal à double émission. Le corps lumineux et le disque réfléchissant glissent silencieusement le long des câbles, assurant un éclairage parfaitement modulable. Les deux éléments, qui se déplacent en sens inverse, diffusent une lumière plus directe ou indirecte en fonction de la distance qui les sépare. Conçu en 1957 et réalisé l'année suivante en deux pièces uniques pour la Chambre de commerce de Milan, Saliscendi est aujourd'hui réaménagé avec des sources LED dimmables.

• **Corps, parabole et pavillon en métal, diffuseurs en PMMA. Finitions : grey white/blanc, rosso rubino/blanc, verde prato/blanc.**

Saliscendi es una lámpara regulable en metal de doble emisión. El cuerpo luminoso y el disco reflectante se deslizan silenciosamente a lo largo de los cables, asegurando una iluminación perfectamente modulada. Los dos elementos, moviéndose en sentido inverso, pueden difundir más luz directa o indirecta en función de la distancia que los separe. Diseñada en 1957 y realizada al año siguiente en dos ejemplares únicos para la Cámara de Comercio de Milán, ahora Saliscendi se rediseña con fuentes LED dimmables.

• **Cuerpo, parábola y cubierta de cable en metal, difusores en PMMA. Acabados: grey white/blanco, rojo rubí/blanco, verde hierba/blanco.**









SUSPENSION **SALISCENDI**

STILNOVO 2023/24





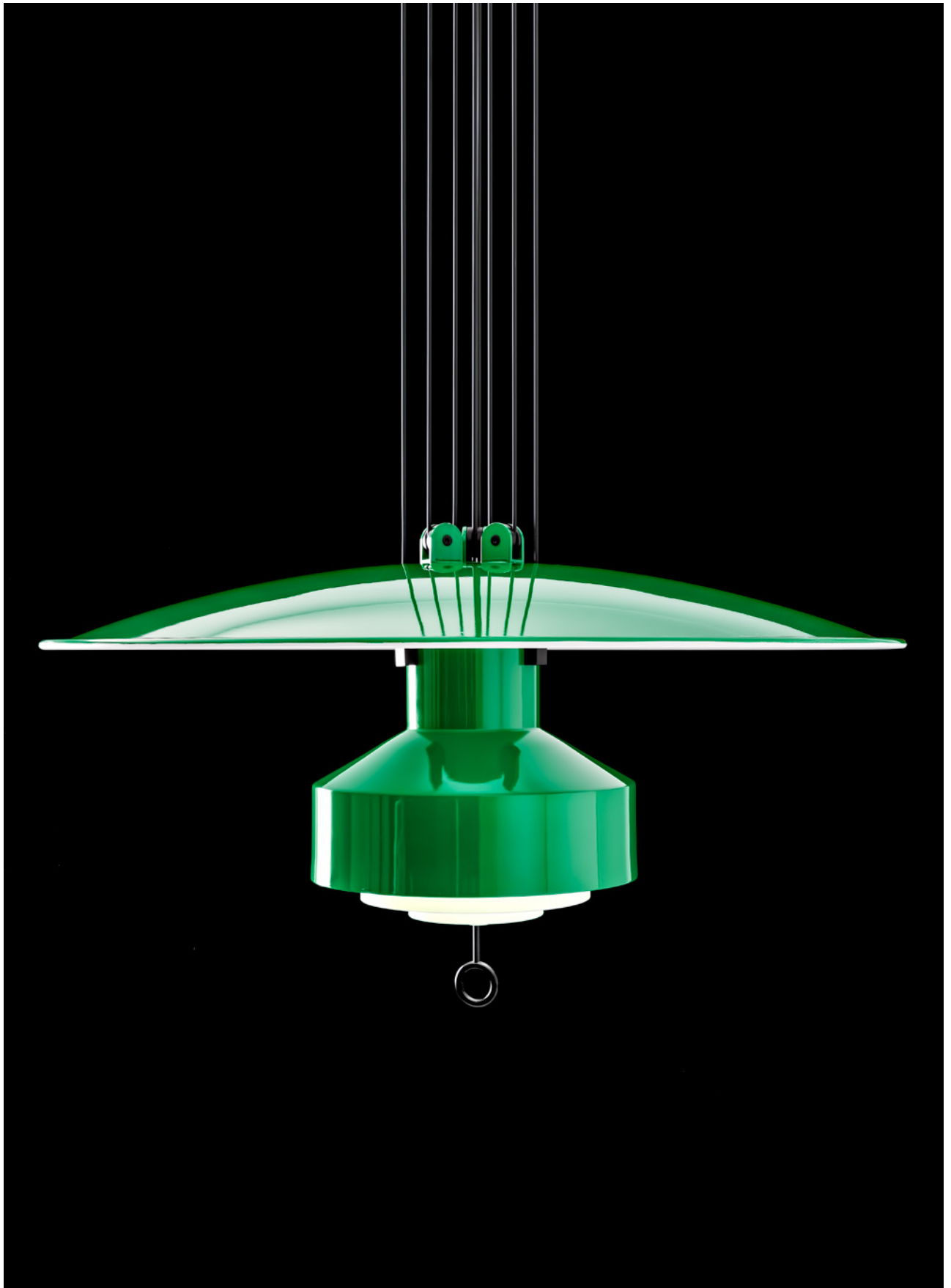

1. Saliscendi



Dimming kits

KIT0079 / CASAMBI
DALI / 1 art / out

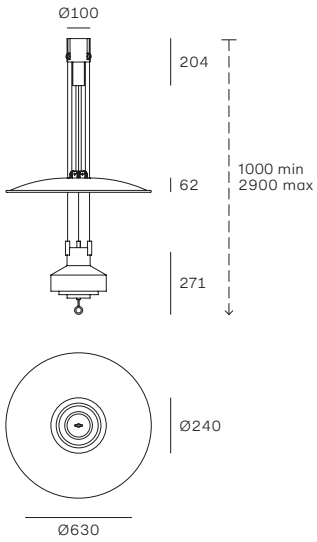

MOD	CODE	FINISH	SOURCE	INPUT	DIMMING	CCT (K)	LUMEN	CRI	IP	OPTICS
1	9310	RU WH	TopLED 36W	220-240V	DALI Push	2700	3672	90	20	Diffused
	9311	LY WH	TopLED 36W	220-240V	DALI Push	2700	3672	90	20	Diffused
	9312	GG WH	TopLED 36W	220-240V	DALI Push	2700	3672	90	20	Diffused

Saturn

2014

Stilnovo

Saturn is a striking luminous ring. The opaline diffuser, available in two diameters, emits uniform and high-performance ambient lighting. The minimalist geometry makes it ideal in the large spaces of modern architecture.

- Polyethylene diffuser, metal wire casing. Finish: white.

Saturn est un imposant anneau de lumière. Le diffuseur opalin, disponible en deux diamètres, émet une lumière d'ambiance uniforme et performante. Sa géométrie essentielle le rend idéal dans les grands espaces de l'architecture contemporaine.

- Diffuseur en polyéthylène, pavillon en métal. Finition : blanc.

Saturn es un imponente anillo luminoso. El difusor opalino, disponible en dos diámetros, emite una luz ambiental uniforme y de altas prestaciones. La geometría esencial lo hace ideal en grandes espacios de arquitectura contemporánea.

- Difusor en polietileno, cubierta de cable en metal. Acabado: blanco.





1. Saturn Ø76



Dimming kits

 **KIT0079** / CASAMBI
DALI / 1 art / in

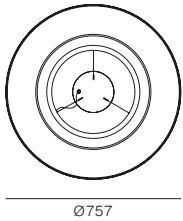
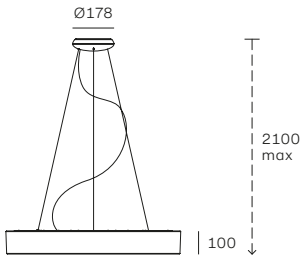

2. Saturn Ø115



Dimming kits

 **KIT0079** / CASAMBI
DALI / 1 art / in

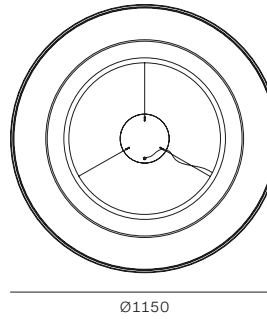
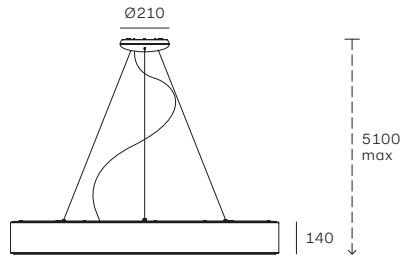

MOD	CODE	FINISH	SOURCE	INPUT	DIMMING	CCT (K)	LUMEN	CRI	IP	OPTICS
1	7652	WH	TopLED 36W	220-240V	DALI Push	3000	3686	90	20	Diffused
	7652N	WH	TopLED 36W	220-240V	DALI Push	4000	4048	90	20	Diffused
2	7650	WH	TopLED 98W	220-240V	DALI Push	3000	13961	90	20	Diffused
	7650N	WH	TopLED 98W	220-240V	DALI Push	4000	14566	90	20	Diffused

Other versions: wall/ceiling, p. 348.

Sputnik

1957

Stilnovo

Like fireworks, the Sputnik expands in all directions in an explosion of light. The sixteen-arm structure in precious brass with galvanic gilding is elegantly combined with the ends available in black, ivory or in the lively multicoloured variant.

• **Body, suspension rod and wire casing in brass, metal ends. Finishes: brass with galvanic gilding/black, brass with galvanic gilding/ivory, brass with galvanic gilding/multicolour.**

Sputnik s'étend dans toutes les directions dans une explosion de lumière, comme un feu d'artifice. La structure à seize bras en laiton précieux avec dorure galvanique est élégamment combinée avec des embouts disponibles en noir, ivoire ou dans la variante multicolore vibrante.

• **Corps, tige de suspension et pavillon en laiton, embouts en métal. Finitions : laiton avec dorure galvanique/noir, laiton avec dorure galvanique/ivoire, laiton avec dorure galvanique/multicolore.**

Sputnik se expande en todas direcciones en una explosión de luz, como fuegos artificiales. La estructura de dieciséis brazos en atractivo latón con dorado galvánico se combina elegantemente con los elementos finales, disponibles en negro, marfil o en la vivacidad de la variante multicolor.

• **Cuerpo, varilla de suspensión y cubierta de cable en latón, elementos finales en metal. Acabados: latón con dorado galvánico/negro, latón con dorado galvánico/marfil, latón con dorado galvánico/multicolor.**



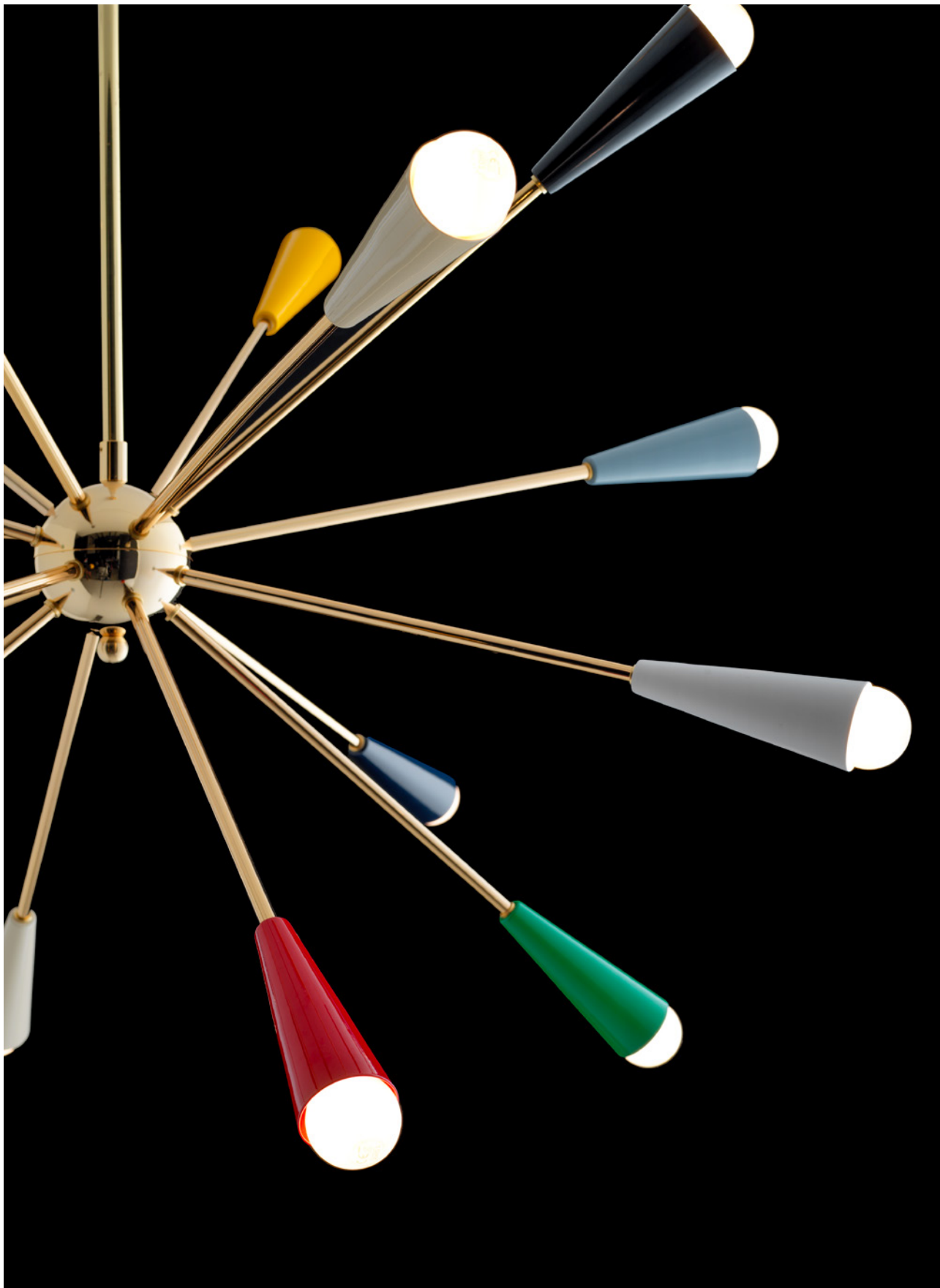





1. Sputnik



*2 stems included

Included bulbs
Miniglobo P45
LED Bulb E14 6W

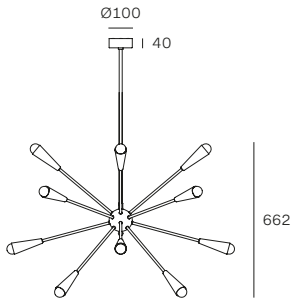

1116 (with longer stem)*

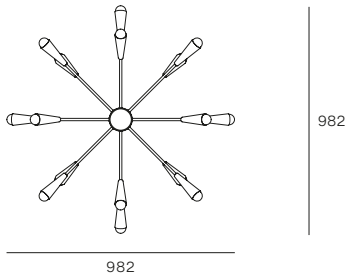
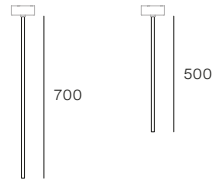

982

982

MOD	CODE	FINISH	SOURCE	INPUT	DIMMING	CCT (K)	LUMEN	CRI	IP	OPTICS
1	9590	AU BB	16xE14 6W	220-240V	No	2700	12896	≥80	20	Diffused
	9591	AU IV	16xE14 6W	220-240V	No	2700	12896	≥80	20	Diffused
	9592	AU	16xE14 6W	220-240V	No	2700	12896	≥80	20	Diffused

Tablet

2014

Mirco Crosatto

Tablet is a family of minimalistic lamps with adjustable light. A thin, rectangular frame houses the mobile light sources which, thanks to the almost complete rotation on its own axis, allows the orientation of direct, indirect or combined beams of light.

• **Aluminium body, opaline polycarbonate diffuser, metal wire casing. Finishes: white, black.**

Tablet est une famille de lampes minimalistes à lumière directionnelle. Dans un fin cadre rectangulaire sont encadrées les sources mobiles qui, grâce à la rotation presque complète sur son axe, permettent l'orientation de faisceaux lumineux directs, indirects ou combinés.

• **Corps en aluminium, diffuseur en polycarbonate opale, pavillon en métal. Finitions : blanc, noir.**

Tablet es una familia de lámparas minimalistas con luz direccional. Las fuentes de luz en movimiento están enmarcadas en un fino marco rectangular que, gracias a la rotación casi completa sobre su eje, permite la orientación de haces de luz directa, indirecta o combinada.

• **Cuerpo en aluminio, difusor en policarbonato opalino, cubierta de cable en metal. Acabados: blanco, negro.**





Trepiù

1972

Gae Aulenti
Livio Castiglioni

Trepiù is an evocative lamp, with an upper shell bearing a marked vintage flavour in two colours and a dome in chromed or glossy white aluminium. Its perfectly-white interior diffuses uniform lighting.

• **Rear shell in plastic material, aluminium dome, metal wire casing. Finishes: white/black shell, chrome/black shell, white/yellow shell, chrome/yellow shell.**

Trepiù est une lampe évocatrice, avec une coque supérieure au goût vintage marqué, disponible en deux couleurs, et un dôme en aluminium chromé ou blanc poli. Son intérieur, parfaitement blanc, diffuse une illumination uniforme.

• **Coque arrière en plastique, dôme en aluminium, pavillon en métal. Finitions : blanc/coque noire, chromé/coque noire, blanc/coque jaune, chromé/coque jaune.**

Trepiù es una sugerente lámpara, con una carcasa superior de marcado sabor vintage en dos variaciones de color y una cúpula en aluminio cromado o blanco brillante. Su interior, perfectamente blanco, difunde una iluminación uniforme.

• **Carcasa trasera en material plástico, cúpula en aluminio, cubierta de cable en metal. Acabados: blanco/carcasa negra, cromo/carcasa negra, blanco/carcasa amarilla, cromo/carcasa amarilla.**





SUSPENSION - TREPIÙ

STILNOVO 2023/24



SUSPENSION TREPIÙ

STILNOVO 2023/24



1. Trepìu



Dimming kits

KIT0079 / CASAMBI
DALI / 1 art / out

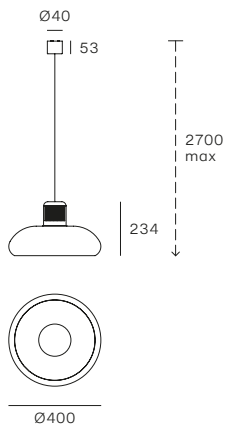

MOD	CODE	FINISH	SOURCE	INPUT	DIMMING	CCT (K)	LUMEN	CRI	IP	OPTICS
1	9305	CH BB	TopLED 27W	220-240V	DALI Push	3000	2535	90	20	Diffused
	9306	CH YY	TopLED 27W	220-240V	DALI Push	3000	2535	90	20	Diffused
	9307	WH BB	TopLED 27W	220-240V	DALI Push	3000	2535	90	20	Diffused
	9308	WH YY	TopLED 27W	220-240V	DALI Push	3000	2535	90	20	Diffused

Triedro

1970

Joe Colombo

Triedro is reminiscent of lighting from a photo shoot. Housing a silver-domed LED bulb, the lampshade is comprised of three contoured and bent metal parts in order to reflect the light downward, without creating glare.

• **Metal lampshade and bulb holder. Wire casing in plastic material. Finish: white/black.**

Triedro évoque les lampes de scène des décors photographiques. L'abat-jour, contenant une ampoule LED à calotte argentée, est en métal façonné et plié en trois parties, de manière à réfléchir la lumière vers le bas, sans éblouir.

• **Abat-jour et support de lampe en métal. Pavillon en plastique. Finitions : blanc/noir.**

Triedro recrea las lámparas de escena de los sets fotográficos. La pantalla, que contiene una bombilla LED de cúpula plateada, es de metal conformado y plegado en tres partes, a fin de reflejar la luz hacia abajo, sin deslumbrar.

• **Pantalla y portalámparas en metal. Cubierta de cable en material plástico. Acabado: blanco/negro.**





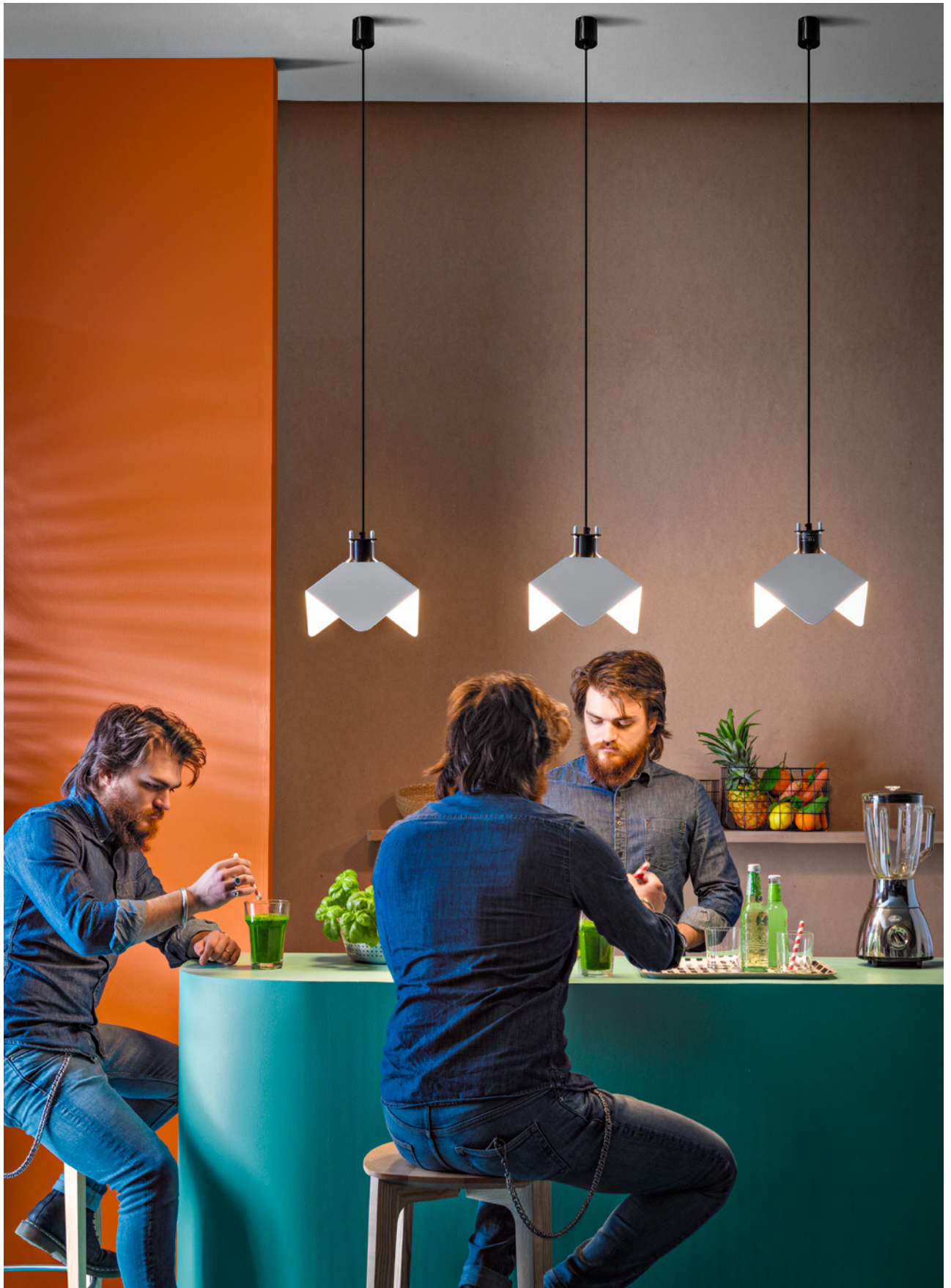

1. Tredro



Included bulb
Classic A Mirror
LED Bulb E27 7W

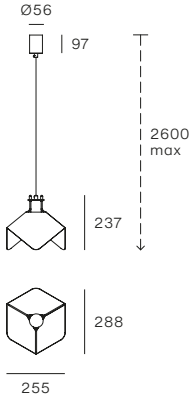

MOD	CODE	FINISH	SOURCE	INPUT	DIMMING	CCT (K)	LUMEN	CRI	IP	OPTICS
1	8995	BB WH	1xE27 7W	220-240V	No	2700	650	≥80	20	Diffused

Other versions: floor, p. 138; wall/ceiling, p. 356.

Xilema

2014

Edin Dedovic

In the Xilema pendant fixture, the upper joint permits perpendicular orientation to be consistently maintained, even in installations with sloped ceilings. Geometrical perfection and elevated technology unite thanks to the WallWasher optics with soft-touch on/off, for the diffusion of a delicate and subdued light on the walls.

• **Aluminium body, PMMA diffuser. Finishes: white, polished aluminium.**

Dans la suspension Xilema, l'articulation supérieure permet de toujours maintenir une orientation perpendiculaire au sol, même dans les installations avec des plafonds inclinés. La perfection géométrique et la haute technologie se rencontrent grâce à l'optique WallWasher, à commutation soft-touch, qui diffuse une lumière délicate et douce sur les murs.

• **Corps en aluminium, diffuseur en PMMA. Finitions blanc, aluminium brillant.**

En Xilema suspensión, la articulación superior permite mantener siempre una orientación perpendicular al suelo, incluso en instalaciones con techos inclinados. La perfección geométrica y la alta tecnología se unen gracias a la óptica WallWasher, con encendido soft-touch, que difunde una luz delicada y difusa en las paredes.

• **Cuerpo en aluminio, difusor en PMMA. Acabados: blanco, aluminio brillante.**







1. Xilema

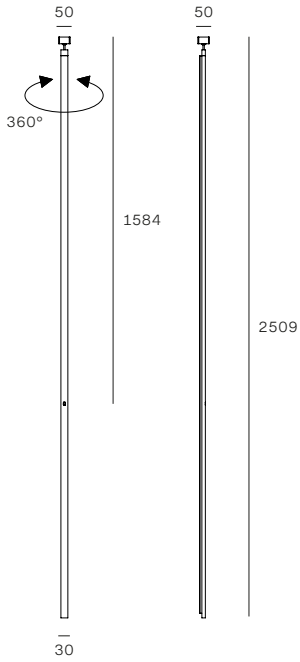

MOD	CODE	FINISH	SOURCE	INPUT	DIMMING	CCT (K)	LUMEN	CRI	IP	OPTICS
1	7773	WH	TopLED 25W	220-240V	Touch	3000	2926	90	20	Double asym.
	7774	PA	TopLED 25W	220-240V	Touch	3000	2926	90	20	Double asym.

Other versions: wall/ceiling, p. 360.

Wall/ceiling

Mur/plafond
Pared/techo

Table
Table
Mesa

14

Floor
Sol
Tierra

92

Suspension
Suspension
Suspensión

144



Bugia	266
Demí	272
Diphy	276
Dynamic	280
Fante	284
Galassia	288
Goletta	294
Gravitino 541	298
Honey	302
Inbilico	306
Lama	312
Lampiatto	316
Megafono	320
Minibox	324
Mr Magoo	328
Oxygen	332
Quad	338
Reflexio	342
Saturn	348
Tablet	352
Triedro	356
Xilema	360
Xilema system	364
1Night/2Nights	370

Bugia

1977

Roberto Beretta

Antonio Macchi Cassia

The shape of these lamps recalls and celebrates the old-fashioned candle holder with handle, commonly called bugia in Italian, the simplified name of the African city Bidgiaya which supplied most of the wax used to make candles! Today this curious anecdote also accompanies our modern-day Bugia: a table or wall lamp in single or double versions, as simple as it is ingenious.

• **Structure in glossy painted metal, satin glass diffuser. Finishes: white, black, red, green, yellow. Black lampholder and cable.**

La forme de ces lampes rappelle les anciens bougeoirs à manche, communément appelés « bugia » en italien, nom simplifié de la ville africaine Bidgiaya qui fournissait la majeure partie de la cire utilisée pour fabriquer les bougies ! Cette anecdote accompagne aujourd'hui également la Bugia « moderne » : une lampe de table ou murale à simple ou double lumière, aussi simple qu'ingénieuse.

• **Structure en métal peint poli, diffuseur en verre satiné. Ampoules fournies. Finitions : blanc, noir, rouge, vert, jaune. Support de lampe et câble noirs.**

La forma de estas lámparas recuerda a los antiguos candelabros con mango, comúnmente llamados en italiano "bugia", nombre simplificado de la ciudad norteafricana de Bidgiaya, que suministraba la mayor parte de la cera utilizada para fabricar velas. Esta anécdota sigue acompañando hoy a la "moderna" Bugia: lámpara de mesa o de pared de luz simple o doble, tan sencilla como genial.

• **Estructura de metal pintado brillante, difusor de vidrio satinado. Bombillas incluidas. Acabados: blanco, negro, rojo, verde, amarillo. Portalámparas y cable en negro.**

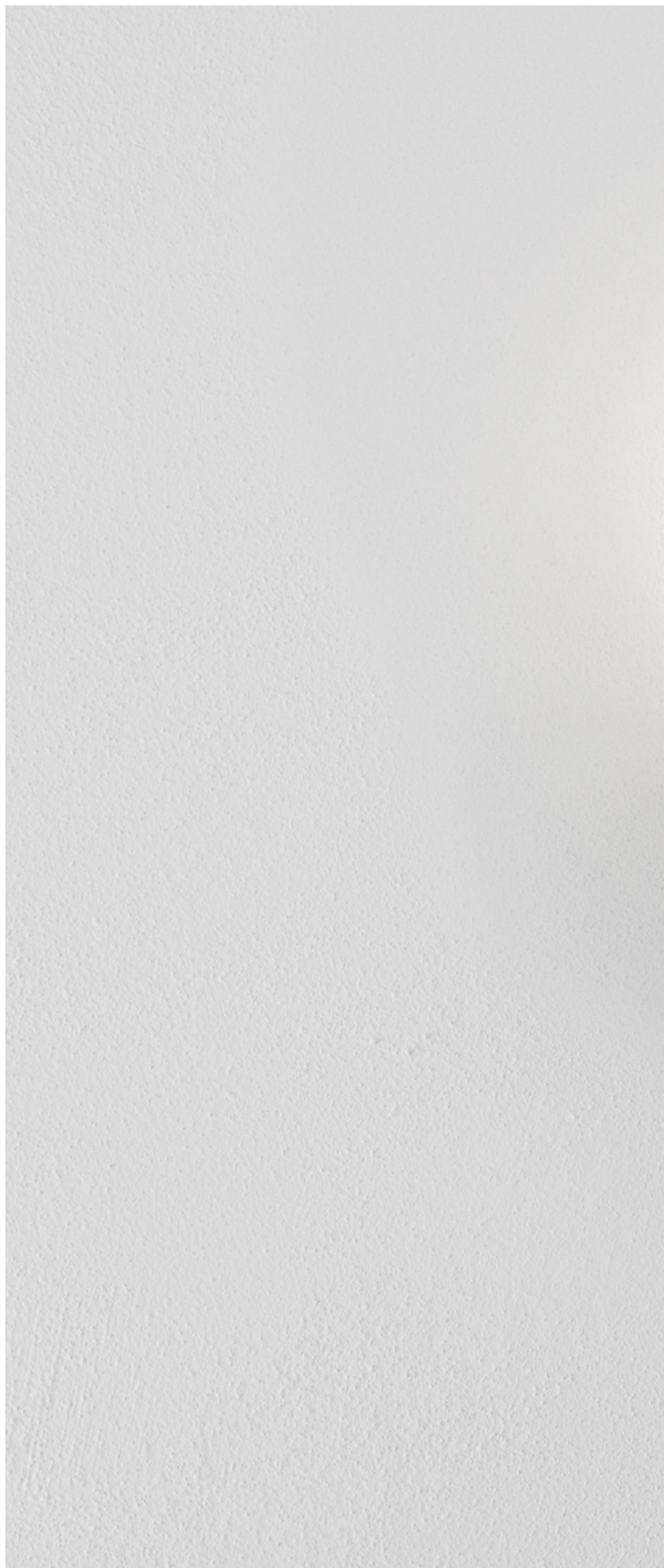







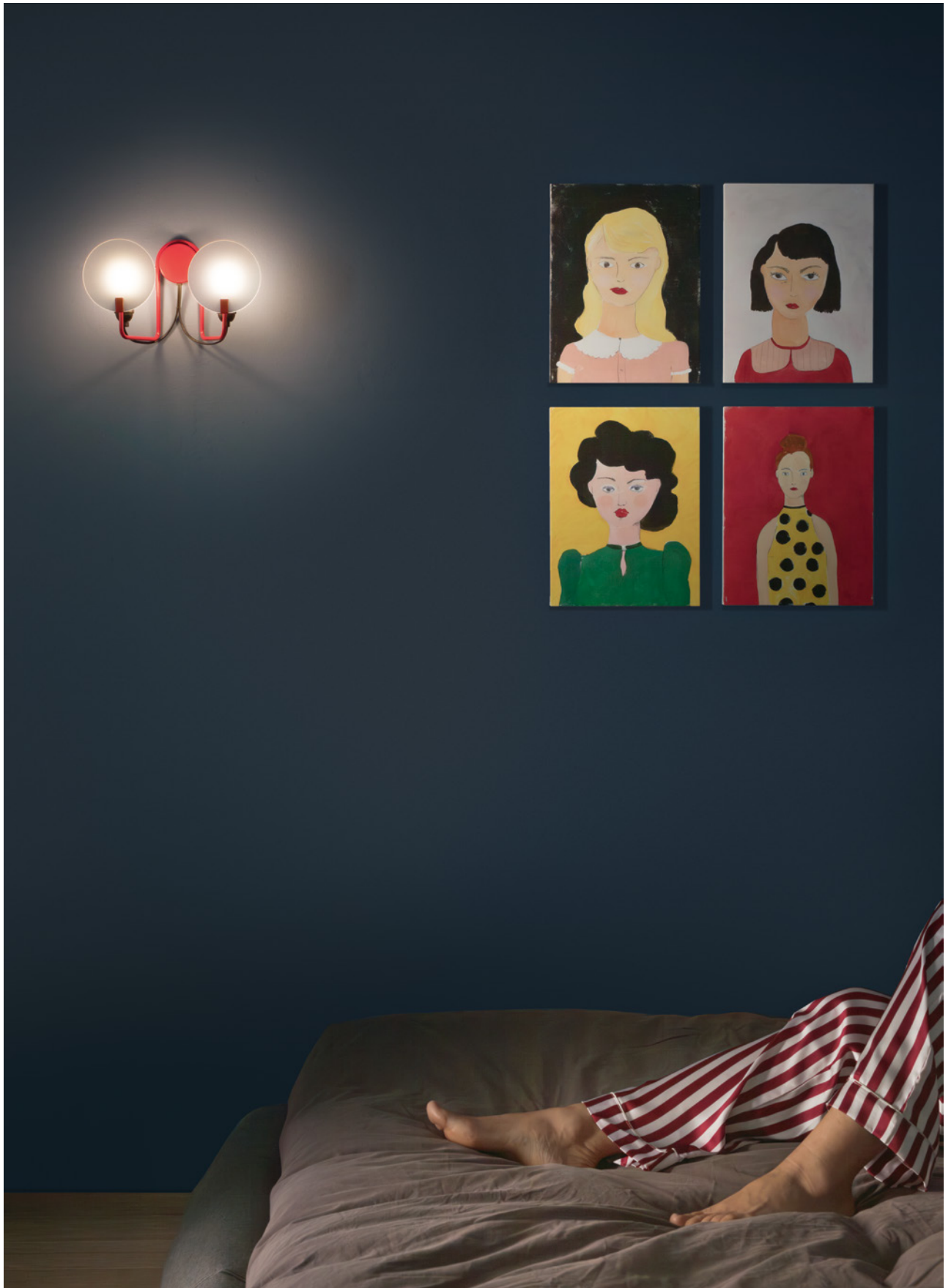

1. Bugia single source



Included bulb
Sfera Full Light
LED Bulb E27 4,5W

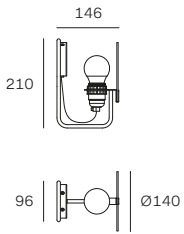

2. Bugia 2 sources



Included bulbs
Sfera Full Light
LED Bulb 2xE27 4,5W

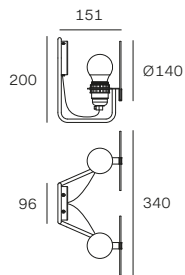

MOD	CODE	FINISH	SOURCE	INPUT	DIMMING	CCT (K)	LUMEN	CRI	IP	OPTICS
1	9686	WH	1xE27 4,5W	220-240V	No	2700	470	80	20	Diffused
	9687	BB	1xE27 4,5W	220-240V	No	2700	470	80	20	Diffused
	9688	GR	1xE27 4,5W	220-240V	No	2700	470	80	20	Diffused
	9689	RI	1xE27 4,5W	220-240V	No	2700	470	80	20	Diffused
	9690	YY	1xE27 4,5W	220-240V	No	2700	470	80	20	Diffused
	2	9692	WH	2xE27 4,5W	220-240V	No	2700	940	80	20
9693		BB	2xE27 4,5W	220-240V	No	2700	940	80	20	Diffused
9694		GR	2xE27 4,5W	220-240V	No	2700	940	80	20	Diffused
9695		RI	2xE27 4,5W	220-240V	No	2700	940	80	20	Diffused
9696		YY	2xE27 4,5W	220-240V	No	2700	940	80	20	Diffused

Other versions: table, p. 16.

Demí

2019

Mirco Crosatto

When switched off, Demí is a large, transparent dome. When switched on, the lower edge and the thousands of laser micro-incisions on the surface emit soft and uniform light thanks to the exclusive OptiLight™ technology. The light is generated by an invisible LED bulb inside the ring of the large upper opening that, like in Rome's ancient Pantheon, is the source of light.

- **Heat-blown PMMA diffuser, aluminium mounting. Finish: white/transparent.**

Demí, lorsqu'il est éteint, est une grande coupole transparente. Grâce à la technologie exclusive OptiLight™, lorsqu'il est allumé, le bord inférieur et les milliers de micro-incisions laser de la surface diffusent une lumière douce et homogène. Celle-ci est générée par une source LED invisible située dans l'anneau du grand trou supérieur qui, comme dans l'ancien Panthéon, est la source de lumière.

- **Diffuseur en PMMA soufflé à chaud, cadre en aluminium. Finition : blanc/transparent.**

Cuando está apagada, Demí es una gran cúpula transparente. Gracias a la exclusiva tecnología OptiLight™, cuando se enciende, el borde inferior y los miles de micrograbados láser de la superficie difunden una iluminación suave y homogénea. Es generada por una fuente LED invisible situada en el anillo del gran orificio superior que, como sucede en el antiguo Panteón, es el origen de la luz.

- **Difusor en PMMA termosoplado, estructura en aluminio. Acabados: blanco/transparente.**





WALL/CEILING **DEMÍ**

STILNOVO 2023/24

1. Demí Ø70

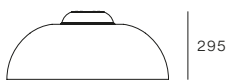

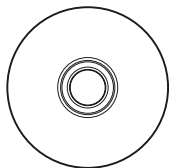

295



Ø700

Dimming kits

-  **KIT0079** / CASAMBI
DALI / 1 art / in
-  **KIT0080** / CASAMBI
PH-CUT / 1 art / in
-  **KIT0026**
PH-CUT / 1-3 art

2. Demí Ø95



389

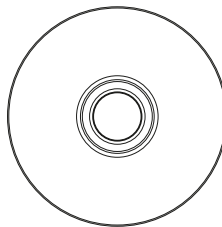

Ø950

Dimming kits

-  **KIT0079** / CASAMBI
DALI / 1 art / in

MOD	CODE	FINISH	SOURCE	INPUT	DIMMING	CCT (K)	LUMEN	CRI	IP	OPTICS
1	8893	WH TR	TopLED 33W	220-240V	Phase-cut	3000	3748	90	20	Diffused
	8893M	WH TR	TopLED 33W	220-240V	Phase-cut	2700	3485	90	20	Diffused
	8894	WH TR	TopLED 37W	220-240V	DALI Push	3000	4198	90	20	Diffused
	8894M	WH TR	TopLED 37W	220-240V	DALI Push	2700	3904	90	20	Diffused
2	8895	WH TR	TopLED 55W	220-240V	DALI Push	3000	6219	90	20	Diffused
	8895M	WH TR	TopLED 55W	220-240V	DALI Push	2700	5784	90	20	Diffused

Other versions: suspension, p. 158.

Diphy

2016

Mirco Crosatto

Diphy is a collection of luminous and transparent petals, combining natural aesthetics with a technological soul. The central source transmits light to the curving edges whilst the micro-incisions of the surfaces create soft and uniform ambient lighting. OptiLight™ technology allows Diphy to disappear from view when switched off, only to magically reappear when switched on.

• **Thermocurved PMMA diffuser, central body and mounting in aluminium. Finish: white/transparent.**

Diphy est une collection de pétales lumineux et transparents qui combine une esthétique organique avec une âme technologique. La source centrale transmet la lumière aux bords sinueux et aux micro-incisions des surfaces, créant ainsi un éclairage d'ambiance doux et homogène. La technologie OptiLight™ permet à Diphy de disparaître de la vue lorsqu'il est éteint et de réapparaître comme par magie lorsqu'il est allumé.

• **Diffuseur en PMMA plié à chaud, corps central et cadre en aluminium. Finition : blanc/transparent.**

Diphy es una colección de pétalos brillantes y transparentes que combina la estética orgánica con un espíritu tecnológico. La fuente central transmite la luz a los bordes sinuosos y a las microincisiones de las superficies, creando una iluminación ambiental suave y homogénea. La tecnología OptiLight™ permite que Diphy desaparezca de la vista cuando se apaga, reapareciendo mágicamente cuando se enciende.

• **Difusor en PMMA termocurvado, cuerpo central y bastidor en aluminio. Acabado: blanco/transparente.**







Dynamic

2010

Stilnovo

Dynamic is a collection of lamps in blown Murano glass that emit bright and uniform light, thanks to the topLED light sources housed in the concave diffusers. Three different sizes allow for multiple combinations in wall-mounting, being easy to install thanks to the practical bayonet mount.

• **Duplex blown glass diffuser, polycarbonate mounting. Finish: white/white.**

Dynamic est une collection de lampes en verre soufflé de Murano qui, grâce aux sources topLED logées à l'intérieur des diffuseurs de forme concave, diffusent une lumière intense et homogène. Trois tailles différentes permettent de multiples combinaisons sur le mur, faciles à installer grâce à la fixation pratique à baïonnette.

• **Diffuseur en verre soufflé duplex, cadre en polycarbonate. Finition : blanc/blanc.**

Dynamic es una colección de lámparas de cristal soplado de Murano que, gracias a las fuentes topLED alojadas en el interior de difusores de forma cóncava, liberan una luz intensa y homogénea. Tres tamaños diferentes permiten múltiples combinaciones de pared, fáciles de instalar gracias a la práctica conexión de bayoneta.

• **Difusor en vidrio soplado dúplex, estructura en polycarbonato. Acabado: blanco/blanco.**

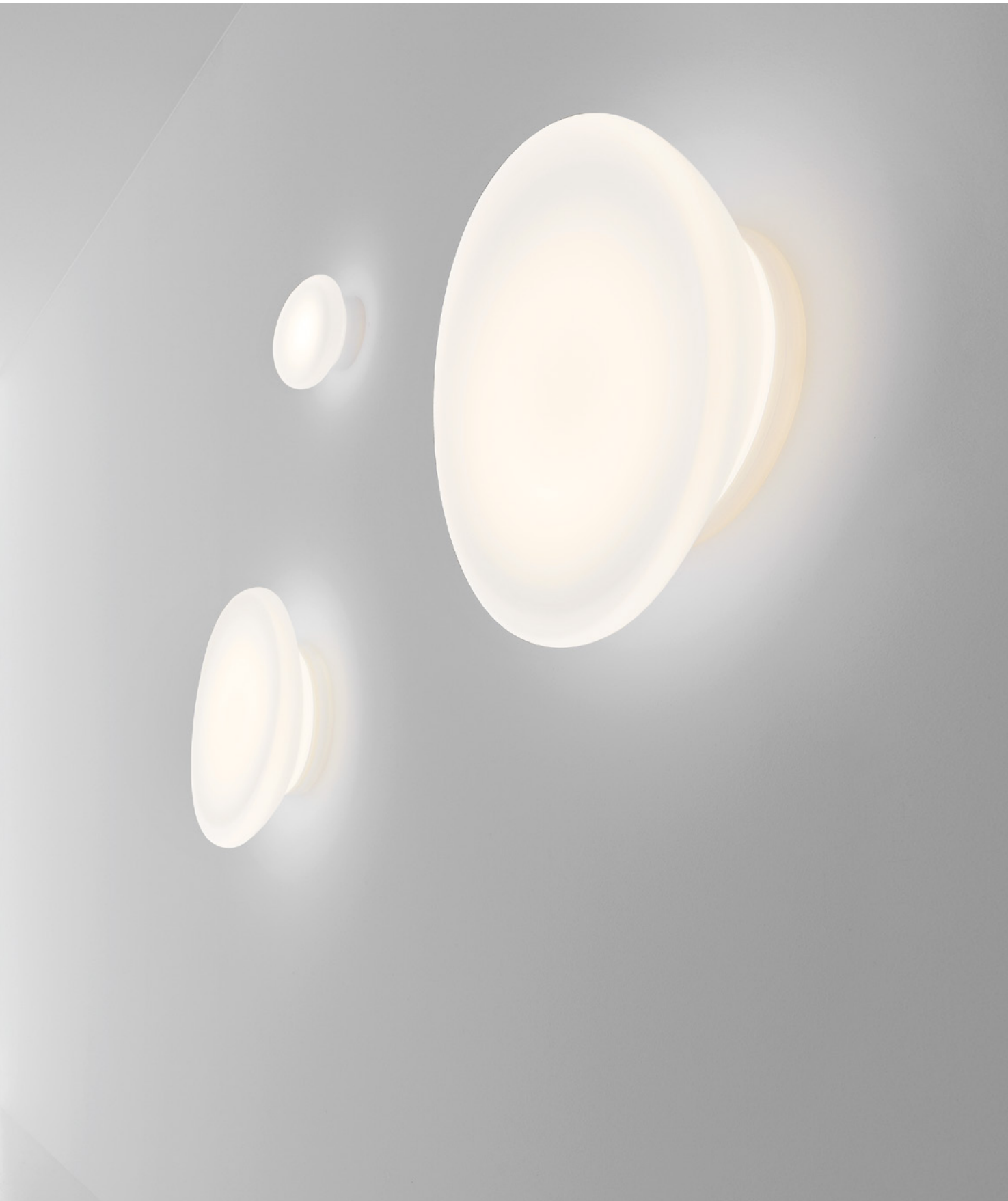

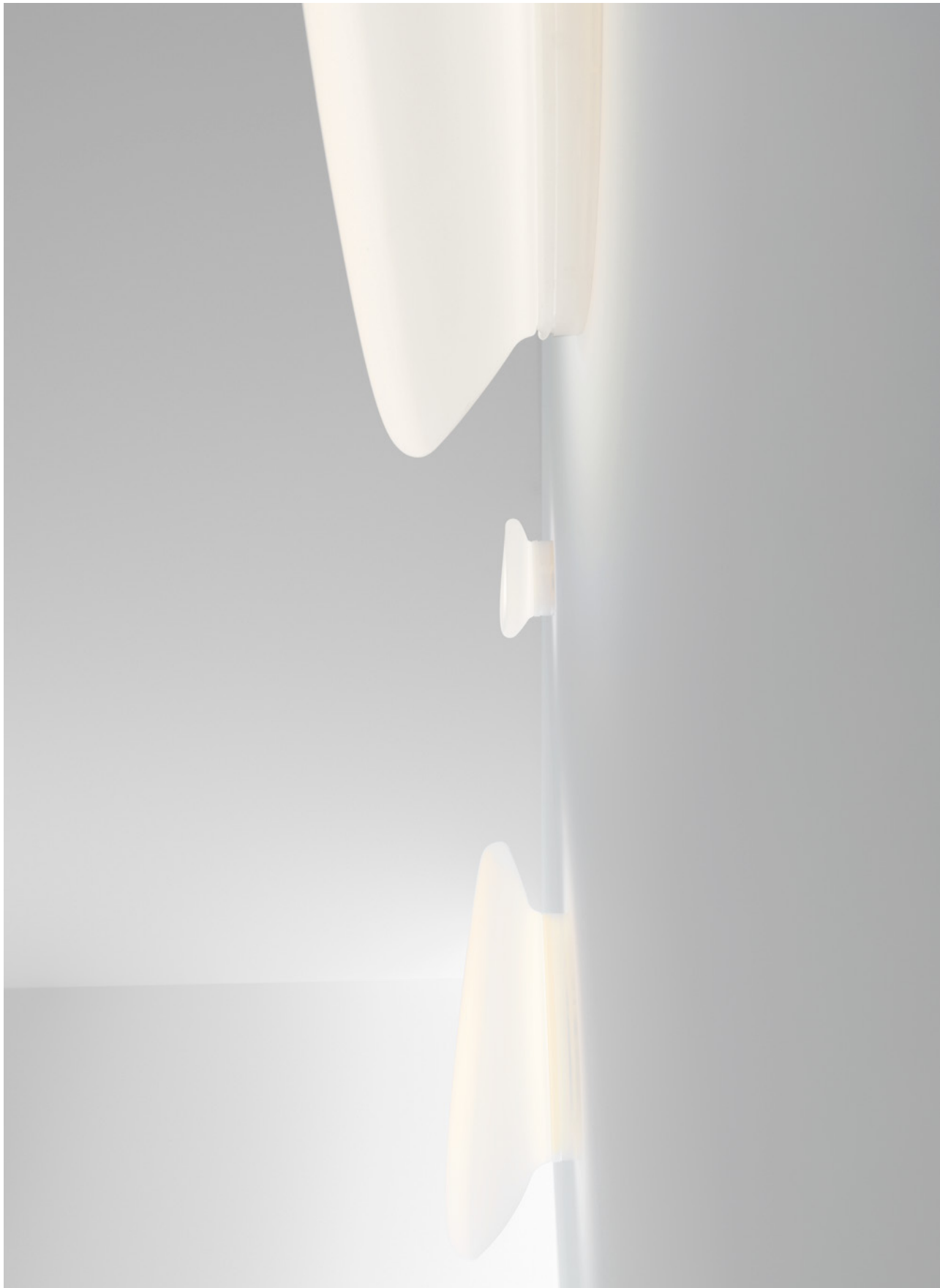

1. Dynamic Ø19

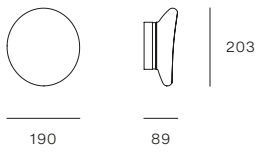

2. Dynamic Ø43

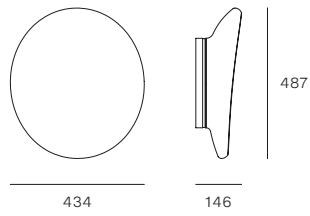

3. Dynamic Ø52

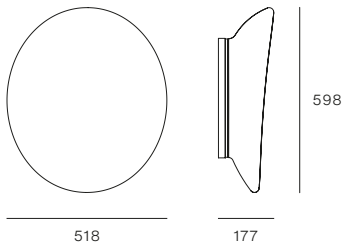

MOD	CODE	FINISH	SOURCE	INPUT	DIMMING	CCT (K)	LUMEN	CRI	IP	OPTICS
1	7785	WH	TopLED 6W	220-240V	No	3000	514	90	44	Diffused
2	7786	WH	TopLED 21W	220-240V	No	3000	2189	90	44	Diffused
3	7787	WH	TopLED 30W	220-240V	No	3000	3077	90	44	Diffused

Fante

1978

Jonathan De Pas
Donato D'Urbino
Paolo Lomazzi

Fante's light is easy to direct, thanks to the adjustable reflector on the bulb. The freedom of inclination allows simultaneous control of both the downward illumination and the indirect diffused light for upward radiance. The conical base is soft and pleasing to the touch, perfectly completing the proportioned design.

• **Conical rubber base, aluminium parabolic diffuser.**

Finishes: brick red/white, black/white.

La lumière de Fante est facile à orienter, grâce au réflecteur réglable sur l'ampoule elle-même. La liberté d'inclinaison permet de contrôler en même temps la lumière vers le bas et la lumière diffusée indirectement vers le haut. La base conique, douce et agréable au toucher, complète son design parfaitement proportionné.

• **Base en caoutchouc, parabole en aluminium. Finitions : rouge brique/blanc, noir/blanc.**

La luz de Fante se orienta con facilidad, gracias al reflector ajustable en la propia bombilla. La libertad de inclinación permite controlar al mismo tiempo tanto la luz descendente como la luz indirecta difusa hacia arriba. La base cónica, suave y agradable al tacto, completa un diseño perfectamente proporcionado.

• **Base de goma, parábola en aluminio. Acabados: rojo ladrillo/blanco, negro/blanco.**



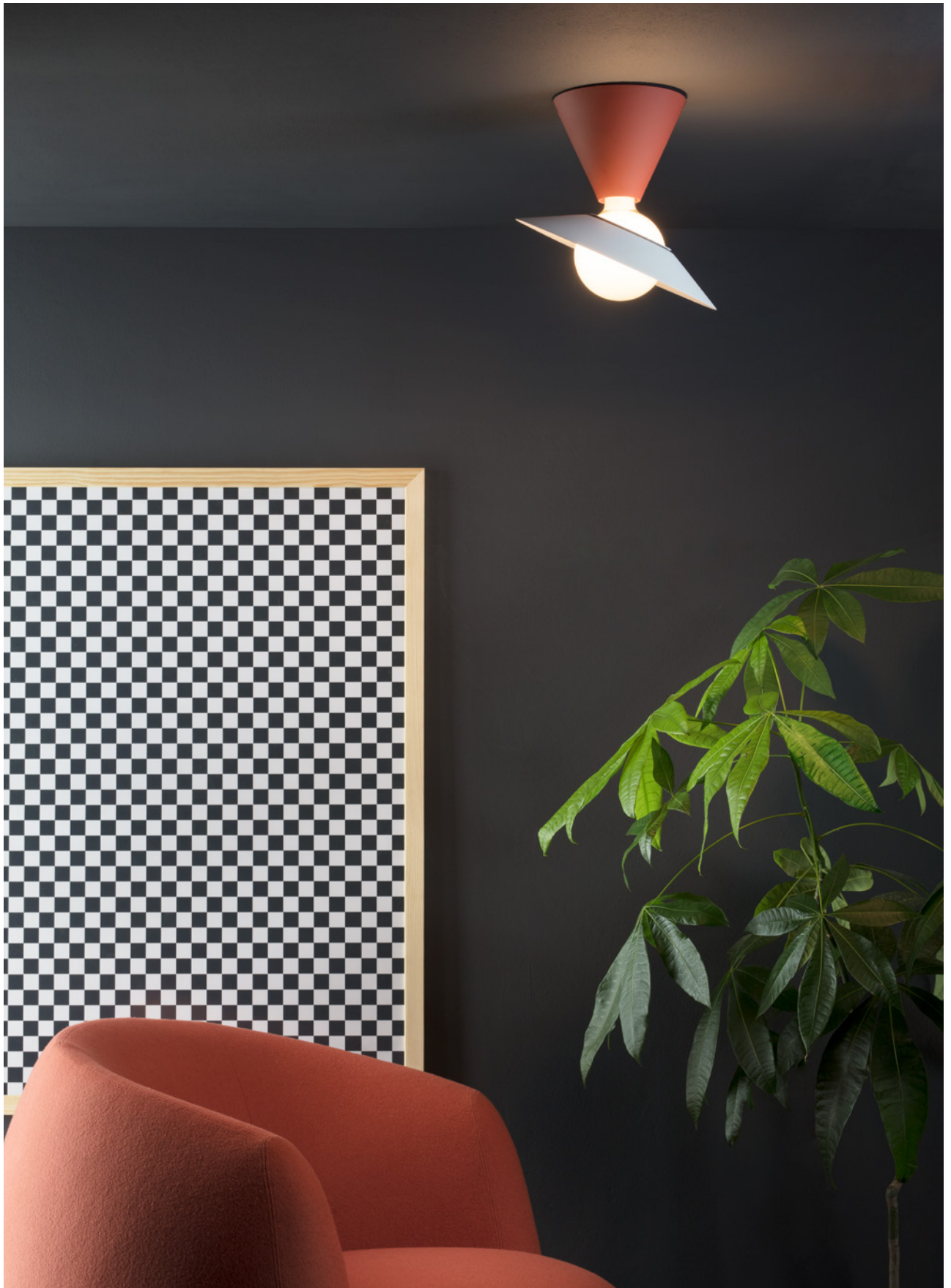

1. Fante



Included bulb
 Globo 125 Full Light
 LED Bulb E27 11W

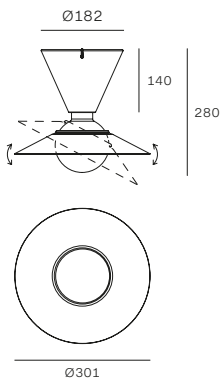

MOD	CODE	FINISH	SOURCE	INPUT	DIMMING	CCT (K)	LUMEN	CRI	IP	OPTICS
1	8967	BB WH	1xE27 11W	220-240V	No	2700	1520	≥80	20	Diffused
	8969	RR WH	1xE27 11W	220-240V	No	2700	1520	≥80	20	Diffused

Other versions: table, p. 24.

Galassia

1959

Stilnovo

The 1950s charm of the Galassia wall light, available with one bulb or two, orientable to the left or right, remains unchanged thanks to the combination of the brass with galvanic gilding on the structure and the white triplex blown glass sphere. A priceless collection that enriches any space with a sophisticated retro touch.

• **Brass body, triplex glass diffusers. Finishes: brass with galvanic gilding/glossy white glass.**

L'applique Galassia, disponible avec une ou deux lumières orientables vers la droite ou la gauche, conserve le charme des années 1950 grâce à la combinaison du laiton avec la dorure galvanique de la structure et les sphères en verre soufflé triplex blanc. Une collection précieuse qui enrichit l'espace d'une touche rétro sophistiquée.

• **Corps en laiton, diffuseurs en verre triplex. Finitions : laiton avec dorure galvanique/verre blanc brillant.**

Galassia para pared, disponible con luz sencilla y con dos luces orientadas a derecha o izquierda, mantiene inalterado el encanto de los años 50 gracias a la combinación del latón con dorado galvánico de la estructura y las esferas de vidrio soplado triplex blanco. Una atractiva colección que enriquece el espacio con un sofisticado toque retro.

• **Cuerpo en latón, difusores en vidrio triplex. Acabados: latón con dorado galvánico/vidrio blanco brillante.**



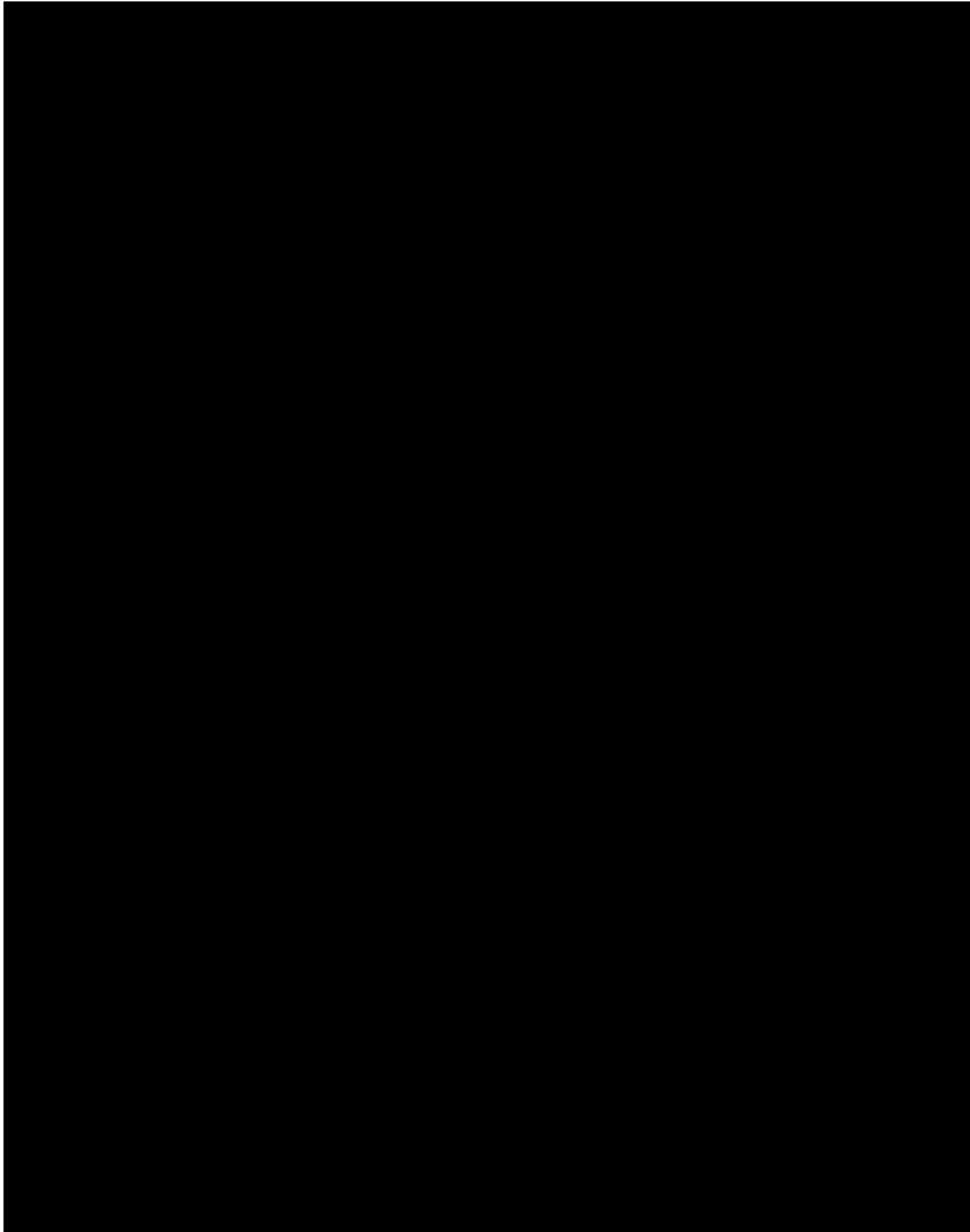



WALL/CEILING **GALASSIA**

STILNOVO 2023/24



1. Galassia single source

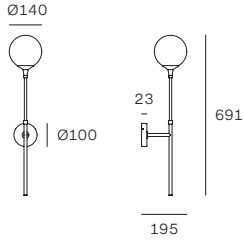
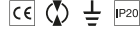

Included bulbs
Miniglobo P45
LED Bulb E14 6W

2. Galassia 2 sources right

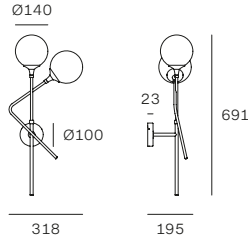

Included bulbs
Miniglobo P45
LED Bulb E14 6W

3. Galassia 2 sources left

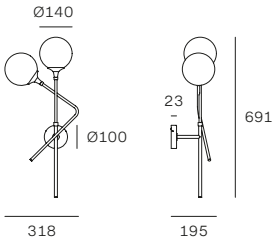

Included bulbs
Miniglobo P45
LED Bulb E14 6W

MOD	CODE	FINISH	SOURCE	INPUT	DIMMING	CCT (K)	LUMEN	CRI	IP	OPTICS
1	9559	AU WH	1xE14 6W	220-240V	No	2700	806	≥80	20	Diffused
2	9557	AU WH	2xE14 6W	220-240V	No	2700	1612	≥80	20	Diffused
3	9558	AU WH	2xE14 6W	220-240V	No	2700	1612	≥80	20	Diffused

Other versions: floor, p. 104; suspension, p. 170.

Goletta

1969

Studio Nizzoli Associati

Goletta is one of the first examples of Stilnovi's use of plastics. A 'three-dimensional' wall or ceiling lamp thanks to its flared shape and special interior structure: the reflector with concentric pyramid circles helps to control the emission of light. Externally, the colours confirm Stilnovi's 'pop' style, while the modular kit allows the creation of scenic compositions.

• **ABS or PMMA lamp body, polished aluminium reflector. Finishes: white/white, black/white, red/white, white/aluminium, black/aluminium, red/aluminium.**

Goletta est l'un des premiers exemples de l'utilisation de matériaux plastiques par Stilnovi. Une lampe murale ou de plafond, tridimensionnelle grâce à sa forme évasée et à sa conception interne spéciale : le réflecteur à cercles pyramidaux concentriques permet de contrôler l'émission de lumière. À l'extérieur, les couleurs confirment l'esprit « pop » de Stilnovi, tandis que le kit modulaire permet des compositions scéniques.

• **Corps de lampe en ABS ou PMMA, réflecteur en aluminium poli. Finitions : blanc/blanc, noir/blanc, rouge/blanc, blanc/aluminium, noir/aluminium, rouge/aluminium.**

Goletta es uno de los primeros ejemplos de uso de materiales plásticos por parte de Stilnovi. Una lámpara de pared o techo "tridimensional" gracias a su forma acampanada y a la particular conformación interna: el reflector en círculos piramidales concéntricos ayuda a controlar la emisión luminosa. En el exterior, los colores confirman el espíritu "pop" de Stilnovi, mientras que el kit modular permite composiciones escenográficas.

• **Cuerpo de lámpara en ABS o PMMA, reflector en aluminio brillante. Acabados: blanco/blanco, negro/blanco, rojo/blanco, blanco/aluminio, negro/aluminio, rojo/aluminio.**







1. Goletta

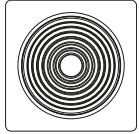

360

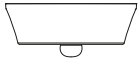

112

Ø292

Included bulb
Classic A Mirror
LED Bulb E27 7W

Connection kit
KIT0111 / 1-4 art.

220/240 V
input

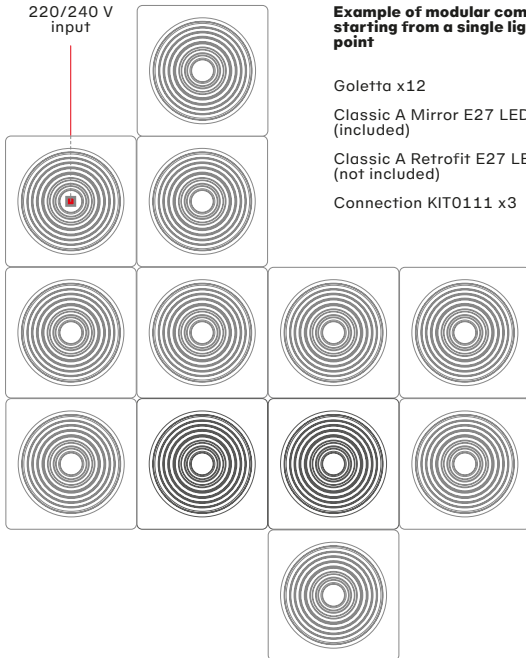

Example of modular composition starting from a single lighting point

Goletta x12
Classic A Mirror E27 LED Bulbs (included)
Classic A Retrofit E27 LED Bulbs (not included)
Connection KIT0111 x3



KIT0111 contains three 5-way connectors, to connect up to four lamps together.
Le KIT0111 contient trois connecteurs à 5 voies, pour brancher jusqu'à 4 lampes ensemble.
El KIT0111 contiene tres conectores de 5 vías para conectar hasta cuatro lámparas entre sí.

MOD	CODE	FINISH	SOURCE	INPUT	DIMMING	CCT (K)	LUMEN	CRI	IP	OPTICS
1	9733	WH WH	1xE27 7W	220-240V	No	2700	650	≥80	20	Diffused
	9734	BB WH	1xE27 7W	220-240V	No	2700	650	≥80	20	Diffused
	9735	RI WH	1xE27 7W	220-240V	No	2700	650	≥80	20	Diffused
	9736	WH AL	1xE27 7W	220-240V	No	2700	650	≥80	20	Diffused
	9737	BB AL	1xE27 7W	220-240V	No	2700	650	≥80	20	Diffused
	9738	RI AL	1xE27 7W	220-240V	No	2700	650	≥80	20	Diffused

Gravitino 541

1969

Antonio Macchi Cassia

In Gravitino 541, a magnet connects the upper sphere, which houses the LED source, to the lower sphere, the base. The magnetic attachment allows total freedom of movement of the light source, which can slide in any direction and rotate 360 degrees. The light source is recessed for improved visual comfort.

• **Sphere and base in glossy painted metal. Finishes: white, black, grey.**

Dans Gravitino 541, un aimant relie la sphère supérieure, qui abrite la source LED, à la sphère inférieure, la base. La fixation magnétique permet une totale liberté de mouvement de la source lumineuse, qui peut glisser dans n'importe quelle direction et tourner à 360 degrés. La source lumineuse est en retrait pour un meilleur confort visuel.

• **Boules et base en métal peint brillant. Finitions : blanc, noir, gris.**

En Gravitino 541, un imán conecta la esfera superior, que alberga la fuente LED, con la esfera inferior que forma la base. La fijación magnética permite una total libertad de movimiento de la fuente luminosa, que puede deslizarse en cualquier dirección y girar 360 grados. La fuente de luz queda retraída para un mayor confort visual.

• **Esfera y base en metal pintado brillante. Acabados: blanco, negro, gris.**





WAITING AREA





WALL/CEILING **GRAVITINO 541**

STILNOVO 2023/24

1. Gravitino 541 ceiling



Dimming kits

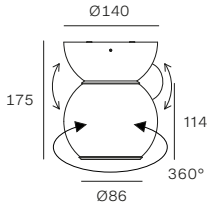

-  **KIT0080** / CASAMBI
PH-CUT / 1-4 art / out
-  **KIT0026**
PH-CUT / 1-9 art



2. Gravitino 541 wall



Dimming kits

-  **KIT0080** / CASAMBI
PH-CUT / 1-4 art / out
-  **KIT0026**
PH-CUT / 1-9 art

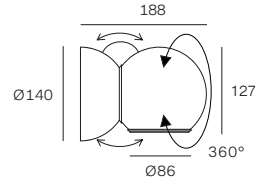

Magnetic connection between spheres



MOD	CODE	FINISH	SOURCE	INPUT	DIMMING	CCT (K)	LUMEN	CRI	IP	OPTICS
1	9717	WH	ArrayLED 11W	220-240V	Phase-cut	3000	1079	90	20	Extra Wide Flood
	9718	BB	ArrayLED 11W	220-240V	Phase-cut	3000	1079	90	20	Extra Wide Flood
	9719	GG	ArrayLED 11W	220-240V	Phase-cut	3000	1079	90	20	Extra Wide Flood
2	9720	WH	ArrayLED 11W	220-240V	Phase-cut	3000	1079	90	20	Extra Wide Flood
	9721	BB	ArrayLED 11W	220-240V	Phase-cut	3000	1079	90	20	Extra Wide Flood
	9722	GG	ArrayLED 11W	220-240V	Phase-cut	3000	1079	90	20	Extra Wide Flood

Other versions: table, p. 36.

Honey

2019

Pio & Tito Toso

The wall-mounted Honey plays on repetition, creating two linear configurations with three or nine modules. The warm light is diffused both directly and indirectly and, curtained by wavy opaline diffusers, creates fascinating nuances.

• **Polycarbonate modules, metal mounting. Finish: glossy white.**

La version murale de Honey joue sur la répétition, créant deux configurations linéaires de trois ou neuf modules. La lumière chaude est diffusée directement et indirectement et, tamisée par des diffuseurs opalins ondulés, donne vie à des nuances fascinantes.

• **Modules en Polycarbonate, cadre en métal. Finitions : blanc-brillant.**

Honey en pared juega con la repetición, creando dos configuraciones lineales de tres o nueve módulos. La luz cálida se difunde tanto directa como indirectamente y, protegida por difusores opalinos ondulados, da vida a tonos fascinantes.

• **Módulos en policarbonato, estructura en metal. Acabado: blanco brillante.**







1. Honey L27



163

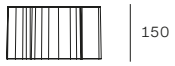

150

272

2. Honey L72

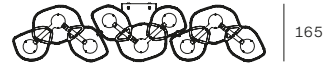

165



150

722

Dimming kits

 **KIT0080** / CASAMBI
PH-CUT / 1-2 art / out

 **KIT0026**
PH-CUT / 1-5 art

MOD	CODE	FINISH	SOURCE (incl.)	INPUT	DIMMING	CCT (K)	LUMEN	CRI	IP	OPTICS
1	8688	WH	TopLED 6W	220-240V	No	2700	563	90	20	Diffused
2	8690	WH	TopLED 20W	220-240V	Phase-cut	2700	2076	90	20	Diffused

Other versions: suspension, p. 178.

Inbilico

2023

Brian Sironi

A wall lamp whose reflected light is the result of the meeting of two volumes: Inbilico creates a sort of unstable equilibrium, accentuated by the inclination of the lamp itself against the wall. It can be installed in two opposite positions 180° apart, turning the light upwards or downwards as desired, with the housing for the light source always parallel to the floor.

• **Finishes: white-white, white-black, white-brushed gold, white-brushed smoke grey.**

Une applique dont la lumière « réfléchi » est créée par la rencontre de deux volumes : Inbilico crée une sorte d'équilibre instable, accentué par l'inclinaison de la lampe elle-même par rapport au mur. Elle peut être installée dans des positions opposées de 180° en tournant la lumière vers le haut ou vers le bas à volonté, en gardant le volume où est logée la source toujours parallèle au sol.

• **Finitions : blanc-blanc, blanc-noir, or brossé blanc, gris fumé brossé blanc.**

Una lámpara de pared con luz "reflejada" que nace del encuentro entre dos volúmenes: Inbilico crea una especie de equilibrio inestable, acentuado por la inclinación de la lámpara con respecto a la pared. Se puede instalar en posiciones opuestas de 180° girando la luz hacia arriba o hacia abajo a voluntad, manteniendo el volumen donde se encuentra la fuente siempre paralelo al suelo.

• **Acabados: blanco-blanco, blanco-negro, blanco-oro cepillado, blanco-gris ahumado cepillado.**







WALL/CEILING **INBILICO**

STILNOVO 2023/24



1. Inbilico



Dimming kits

 **KIT0080** / CASAMBI
PH-CUT / 1 art / in

 **KIT0026**
PH-CUT / 1-3 art

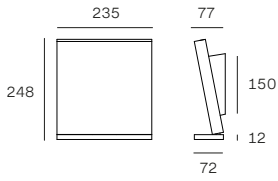

MOD	CODE	FINISH	SOURCE	INPUT	DIMMING	CCT (K)	LUMEN	CRI	IP	OPTICS
1	9780	WH WH	TopLED 28W	220-240V	Phase-cut	3000	3735	90	20	Diffused
	9780M	WH WH	TopLED 28W	220-240V	Phase-cut	2700	3490	90	20	Diffused
	9781	HG WH	TopLED 28W	220-240V	Phase-cut	3000	3735	90	20	Diffused
	9781M	HG WH	TopLED 28W	220-240V	Phase-cut	2700	3490	90	20	Diffused
	9782	GG WH	TopLED 28W	220-240V	Phase-cut	3000	3735	90	20	Diffused
	9782M	GG WH	TopLED 28W	220-240V	Phase-cut	2700	3490	90	20	Diffused
	9783	BB WH	TopLED 28W	220-240V	Phase-cut	3000	3735	90	20	Diffused
	9783M	BB WH	TopLED 28W	220-240V	Phase-cut	2700	3490	90	20	Diffused

Lama

2011

Mirco Crosatto

The Lama collection has a minimalist design. The opaline diffusers are built into the aluminium frame to directly unleash the topLED light, ideal for any modern space.

• **Aluminium body, polycarbonate diffuser. Finishes: white, black.**

Lama est une collection au design minimaliste. Les diffuseurs opalins sont intégrés dans le cadre en aluminium et diffusent une lumière topLED à émission directe, idéale pour tout espace contemporain.

• **Corps en aluminium, diffuseur en polycarbonate. Finitions : blanc, noir.**

Lama es una colección con un diseño minimalista. Los difusores opalinos se integran en el bastidor de aluminio, del que se desprende una luz topLED de emisión directa, idónea en cualquier espacio contemporáneo.

• **Cuerpo en aluminio, difusor en policarbonato. Acabados: blanco, negro.**





1. Lama wall

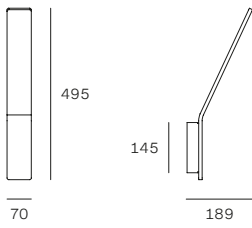

MOD	CODE	FINISH	SOURCE	INPUT	DIMMING	CCT (K)	LUMEN	CRI	IP	OPTICS
1	7104	WH	TopLED 21W	220-240V	No	3000	2505	90	40	Diffused
	7137	BB	TopLED 21W	220-240V	No	3000	2505	90	40	Diffused

Other versions: table, p. 50.

Lampiatta

1971

**Jonathan De Pas
Donato D'Urbino
Paolo Lomazzi**

Lampiatta can be easily repositioned without the use of joints or mechanisms. Indeed, the lampshade is designed to be inserted as desired in one of the four slots of the base, allowing the light to be inclined and directed as desired.

• **Parabolic diffuser in aluminium, body in plastic material, removable base in steel. Finishes: white/white, black/white, red/white.**

Lampiatta peut être facilement repositionnée sans l'utilisation d'articulations ou de mécanismes : l'abat-jour est conçu pour être inséré à volonté dans l'une des quatre fentes de la base, ce qui permet d'incliner et d'orienter la lumière.

• **Parabole en aluminium, corps en plastique, base amovible en acier. Finitions : blanc/blanc, noir/blanc, rouge/blanc.**

Lampiatta se puede reposicionar fácilmente sin el uso de juntas o mecanismos: la pantalla está diseñada para insertarse como se desee en una de las cuatro ranuras de la base, permitiendo la inclinación y orientación de la luz.

• **Parábola en aluminio, cuerpo en material plástico, base extraíble en acero. Acabados: blanco/blanco, negro/blanco, rojo/blanco.**





CHINOTTO

GASSOSA

SPUMA



1. Lampiatta table/wall



Included bulb
Classic A Mirror
LED Bulb E27 7W

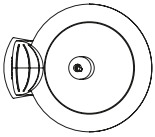
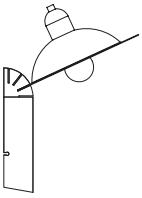

Ø282

327

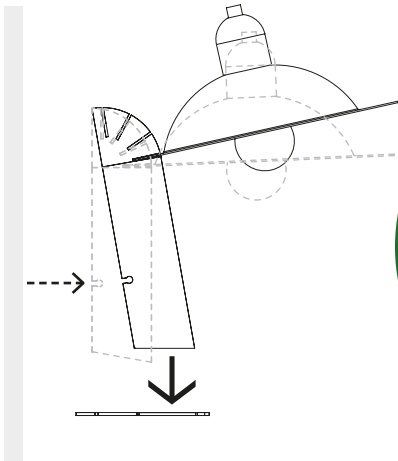

By fixing the steel base (included) to the body, Lampiatta becomes a table lamp.

Si vous fixez la base en acier (incluse) sur le corps, Lampiatta se transforme en une lampe de table.

Lampiatta se convierte en una lámpara de sobremesa al montar al cuerpo la base de acero (incluida).

MOD	CODE	FINISH	SOURCE	INPUT	DIMMING	CCT (K)	LUMEN	CRI	IP	OPTICS
1	8971	WH WH	1xE27 7W	220-240V	No	2700	650	≥80	20	Diffused
	8972	BB WH	1xE27 7W	220-240V	No	2700	650	≥80	20	Diffused
	8973	RR WH	1xE27 7W	220-240V	No	2700	650	≥80	20	Diffused

On table: p. 54. Other versions: suspension, p. 186.

Megafono

1958

Stilnovo

Megafono is an iconic 1950s lamp with both direct and indirect light. In the single- or double-arm wall lamp version, a prized brass structure bearing galvanic gilding combines with conical lampshades in ivory or glossy black finish, illuminating the environment with elegance.

• **Brass body, metal lampshades. Finishes: brass with galvanic gilding, black or ivory lampshades.**

Megafono est une lampe emblématique des années 1950 avec une lumière directe et indirecte. Dans la version applique simple ou double bras, elle associe une précieuse structure en laiton avec dorure galvanique les abat-jour coniques en finition ivoire ou noir brillant, éclairant la pièce avec élégance.

• **Corps en laiton, abat-jour en métal. Finitions : laiton avec dorure galvanique, abat-jour noir ou bien ivoire.**

Megafono es una icónica lámpara de los años 50 con luz directa e indirecta. En la versión de aplique de brazo simple o doble, combina la atractiva estructura de latón con dorado galvánico junto con las pantallas cónicas en acabado marfil o negro brillante, iluminando el espacio con toda elegancia.

• **Cuerpo en latón, pantallas en metal. Acabados: latón con dorado galvánico, pantallas en negro o marfil.**





1. Megafono 1x2 sources

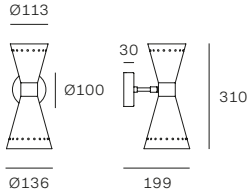
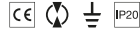

Included bulbs

Miniglobo P45
LED Bulb E14 6W

2. Megafono 2x2 sources

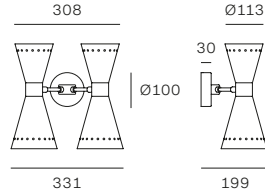

Included bulbs

Miniglobo P45
LED Bulb E14 6W

MOD	CODE	FINISH	SOURCE	INPUT	DIMMING	CCT (K)	LUMEN	CRI	IP	OPTICS
1	9570	AU BB	2xE14 6W	220-240V	No	2700	1612	≥80	20	Diffused
	9571	AU IV	2xE14 6W	220-240V	No	2700	1612	≥80	20	Diffused
2	9572	AU BB	4xE14 6W	220-240V	No	2700	3224	≥80	20	Diffused
	9573	AU IV	4xE14 6W	220-240V	No	2700	3224	≥80	20	Diffused

Other versions: table, p. 58; suspension, p. 194.

Minibox

1981

Gae Aulenti
Piero Castiglioni

The wall-mounted Minibox consists of a metal body and an irreverent luminous eye. The magnetic attachment of the head allows the light to be directed, rendering it suitable for any position.

• **Metal body and directable head with magnetic coupling. Finishes: white, black, coffee, green, red.**

L'applique Minibox est composée d'un corps métallique et d'un œil lumineux irrévérencieux. L'accouplement magnétique de la tête permet d'orienter la lumière, ce qui la rend adaptée à chaque endroit.

• **Corps et tête métalliques orientables avec accouplement magnétique. Finitions : blanc, noir, café, vert, rouge.**

Minibox de pared está compuesta por un cuerpo en metal y un irreverente ojo luminoso. El acoplamiento magnético del cabezal permite orientar la luz, haciéndola adecuada para cualquier lugar.

• **Cuerpo y cabezal orientable en metal con acoplamiento magnético. Acabados: blanco, negro, café, verde, rojo.**









1. Minibox



Dimming kits

-  **KIT0080** / CASAMBI
PH-CUT / 1-4 art / out
-  **KIT0026**
PH-CUT / 1-10 art

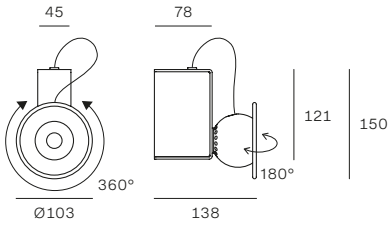

Magnetic head-body connection



MOD	CODE	FINISH	SOURCE	INPUT	DIMMING	CCT (K)	LUMEN	CRI	IP	OPTICS
1	9275	WH	PowerLED 10W	220-240V	Phase-cut	3000	640	90	20	Flood
	9276	BB	PowerLED 10W	220-240V	Phase-cut	3000	640	90	20	Flood
	9277	CF	PowerLED 10W	220-240V	Phase-cut	3000	640	90	20	Flood
	9278	GR	PowerLED 10W	220-240V	Phase-cut	3000	640	90	20	Flood
	9279	RR	PowerLED 10W	220-240V	Phase-cut	3000	640	90	20	Flood

Other versions: table, p. 66.

Mr Magoo

2010

Mirco Crosatto

Mr Magoo is a luminous cloud that adorns and delights with supple and natural lines. The light source is entirely integrated and emits soft and diffused light. Multiple elements allow the creation of an extensive array of scenographies.

• **Polyethylene diffuser, metal mounting. Finish: white.**

Mr Magoo est un nuage lumineux qui meuble et surprend par ses lignes sinueuses et naturelles. La source est complètement intégrée et émet une lumière douce et diffuse. Plusieurs éléments permettent de créer des scénographies très variées.

• **Diffuseur en polyéthylène, cadre en métal. Finition : blanc.**

Mr Magoo es una nube luminosa que decora y sorprende con sus líneas sinuosas y naturales. La fuente luminosa está completamente integrada y emite una luz suave y difusa. Diferentes elementos permiten la creación de escenografías de amplio espectro.

• **Difusor en polietileno, estructura en metal. Acabado: blanco.**







1. Mr Magoo Ø52

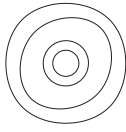

Ø520

Dimming kits

- KIT0079** / CASAMBI
DALI / 1 art / in
- KIT0080** / CASAMBI
PH-CUT / 1-2 art / in
- KIT0026**
PH-CUT / 1-4 art

2. Mr Magoo Ø76

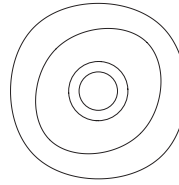

Ø760

Dimming kits

- KIT0079** / CASAMBI
DALI / 1 art / in
- KIT0080** / CASAMBI
PH-CUT / 1 art / in
- KIT0026**
PH-CUT / 1-3 art

3. Mr Magoo Ø115

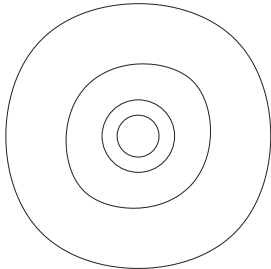
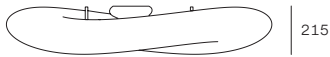

Ø1150

Dimming kits

- KIT0079** / CASAMBI
DALI / 1 art / in

MOD	CODE	FINISH	SOURCE	INPUT	DIMMING	CCT (K)	LUMEN	CRI	IP	OPTICS
1	7792	<input type="text" value="WH"/>	1x2GX13 23W	220-240V	No	3000	1900	≥80	40	Diffused
	8006	<input type="text" value="WH"/>	TopLED 23W	220-240V	DALI Push	3000	2189	90	40	Diffused
	8006N	<input type="text" value="WH"/>	TopLED 23W	220-240V	DALI Push	4000	2419	90	40	Diffused
	8136	<input type="text" value="WH"/>	TopLED 23W	220-240V	Phase-cut	3000	2794	90	40	Diffused
2	8008	<input type="text" value="WH"/>	TopLED 32W	220-240V	DALI Push	3000	3077	90	40	Diffused
	8008N	<input type="text" value="WH"/>	TopLED 32W	220-240V	DALI Push	4000	3577	90	40	Diffused
	8138	<input type="text" value="WH"/>	TopLED 32W	220-240V	Phase-cut	3000	3929	90	40	Diffused
3	7789	<input type="text" value="WH"/>	TopLED 96W	220-240V	DALI Push	3000	11734	90	40	Diffused
	7789N	<input type="text" value="WH"/>	TopLED 96W	220-240V	DALI Push	4000	12644	90	40	Diffused

Other versions: floor, p. 116; suspension, p. 204.

Oxygen

2016

Pio & Tito Toso

Oxygen adapts to any setting, both in the small and larger varieties. It houses an OptiLight™ diffuser, which generates delicate and uniform illumination, directed downwards and upwards. The Oxygen collection is both vast and versatile thanks to the various dimensions and finishes available.

• **Polyurethane lampshade, PMMA diffuser, metal mounting. Finishes: white/white, black/white, yellow/white, light blue/white.**

Oxygen s'adapte à tous les contextes, aussi bien dans sa petite version que dans sa version plus généreuse. Il abrite à l'intérieur le diffuseur OptiLight™, qui développe une lumière délicate et uniforme, tant vers le bas que vers le haut. Oxygen est une collection large et polyvalente grâce aux différentes tailles et finitions disponibles.

• **Abat-jour en polyuréthane, diffuseur en PMMA, cadre en métal. Finitions : blanc/blanc, noir/blanc, jaune/blanc, bleu/blanc.**

Oxygen se adapta a cualquier contexto, tanto en la versión pequeña como en la de medidas más generosas. En su interior alberga el difusor OptiLight™, que desarrolla una luz delicada y uniforme, tanto hacia abajo como hacia arriba. Oxygen es una colección amplia y versátil, gracias a los diferentes tamaños y acabados disponibles.

• **Pantalla en poliuretano, difusor en PMMA, estructura en metal. Acabados: blanco/blanco, negro/blanco, amarillo/blanco, azul/blanco.**

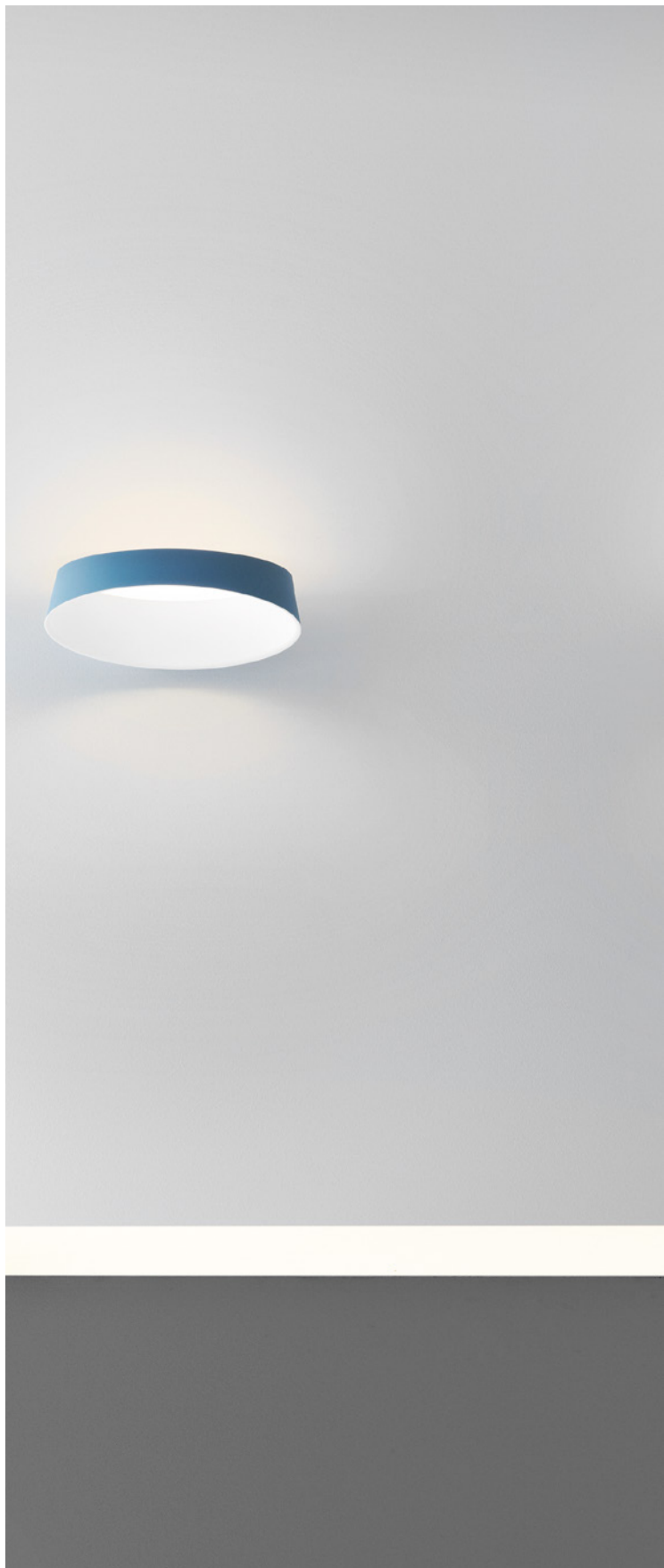







WALL/CEILING **OXYGEN**

STILNOVO 2023/24



1. Oxygen wall small

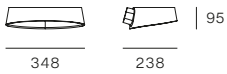

Dimming kits

- KIT0079** / CASAMBI
DALI / 1 art / out
- KIT0080** / CASAMBI
PH-CUT / 1-2 art / out
- KIT0026**
PH-CUT / 1-5 art

2. Oxygen ceiling Ø56

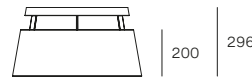

Dimming kits

- KIT0079** / CASAMBI
DALI / 1 art / in

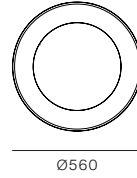

3. Oxygen ceiling Ø75

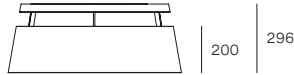

Dimming kits

- KIT0079** / CASAMBI
DALI / 1 art / in

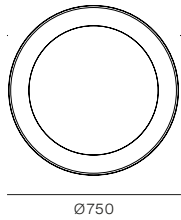

MOD	CODE	FINISH	SOURCE	INPUT	DIMMING	CCT (K)	LUMEN	CRI	IP	OPTICS
1	8185	WH WH	TopLED 17W	220-240V	DALI	3000	1674	90	40	Diffused
	8186	BB WH	TopLED 17W	220-240V	DALI	3000	1674	90	40	Diffused
	8187	YY WH	TopLED 17W	220-240V	DALI	3000	1674	90	40	Diffused
	8188	AZ WH	TopLED 17W	220-240V	DALI	3000	1674	90	40	Diffused
	8495	WH WH	TopLED 17W	220-240V	Phase-cut	3000	1674	90	40	Diffused
	8496	BB WH	TopLED 17W	220-240V	Phase-cut	3000	1674	90	40	Diffused
	8497	YY WH	TopLED 17W	220-240V	Phase-cut	3000	1674	90	40	Diffused
	8498	AZ WH	TopLED 17W	220-240V	Phase-cut	3000	1674	90	40	Diffused
2	8081	WH WH	TopLED 36W	220-240V	DALI Push	3000	3431	90	20	Diffused
	8082	BB WH	TopLED 36W	220-240V	DALI Push	3000	3431	90	20	Diffused
	8083	YY WH	TopLED 36W	220-240V	DALI Push	3000	3431	90	20	Diffused
	8084	AZ WH	TopLED 36W	220-240V	DALI Push	3000	3431	90	20	Diffused
3	8085	WH WH	TopLED 50W	220-240V	DALI Push	3000	4778	90	20	Diffused
	8086	BB WH	TopLED 50W	220-240V	DALI Push	3000	4778	90	20	Diffused
	8087	YY WH	TopLED 50W	220-240V	DALI Push	3000	4778	90	20	Diffused
	8088	AZ WH	TopLED 50W	220-240V	DALI Push	3000	4778	90	20	Diffused

Other versions: floor, p. 120; suspension, p. 212.

Quad

2014

Pio & Tito Toso

The wall version of Quad is comprised of two bodies. With a square base, the light form is structured through the coupled corners. The resulting body, in cast aluminium, houses a light source with indirect emission. The Quad gives its best in succession or in grouped arrangements for suggestive atmospheres of diffused light.

• **Aluminium module, polycarbonate diffuser, metal mounting. Finishes: white, black.**

La version murale de Quad est composée de deux volumes à base carrée qui se fondent dans une structure constituée d'arêtes connectées. Le corps en aluminium moulé sous pression qui en résulte abrite une source d'émission indirecte. Quad s'exprime le mieux en succession ou dans des compositions agrégées, pour des atmosphères suggestives de lumière diffuse.

• **Modules en aluminium, diffuseur en polycarbonate, cadre en métal. Finitions : blanc, noir.**

La versión de pared de Quad está formada por dos volúmenes de base cuadrada que se funden en una estructura formada por aristas unidas. El cuerpo resultante, de aluminio inyectado, alberga una fuente de emisión indirecta. Quad se expresa mejor en secuencia o en composiciones agregadas, para atmósferas sugerentes de luz difusa.

• **Módulo en aluminio, difusor en policarbonato, estructura en metal. Acabados: blanco, negro.**







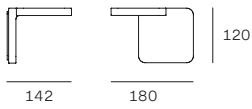

1. Quad



Dimming kits

-  **KIT0080** / CASAMBI
PH-CUT / 1-2 art / out
-  **KIT0026**
PH-CUT / 1-5 art



MOD	CODE	FINISH	SOURCE (incl.)	INPUT	DIMMING	CCT (K)	LUMEN	CRI	IP	OPTICS
1	7750	WH	TopLED 19W	220-240V	Phase-cut	3000	1530	90	40	Diffused
	7753	BB	TopLED 19W	220-240V	Phase-cut	3000	1530	90	40	Diffused

Other versions: suspension, p. 218.

Reflexio

2018

Mirco Crosatto

Reflexio is a large disc of reflected light in which the exterior light source is entirely invisible. The light beam is uniformly distributed by the dome-shaped reflector, providing soft, indirect and comfortable illumination.

• **Metal body. Finishes: white/white, black/white, chocolate/white.**

Reflexio est un grand disque de lumière réfléchie, dans lequel la source périphérique est totalement invisible. Le faisceau lumineux est uniformément réparti par le réflecteur bombé pour un éclairage indirect, doux et confortable.

• **Corps en métal. Finitions : blanc/blanc, noir/blanc, chocolat/blanc.**

Reflexio es un gran disco de luz reflejada, en el que la fuente perimetral es completamente invisible. El haz de luz se distribuye uniformemente por el reflector de cúpula, para una iluminación indirecta, suave y confortable.

• **Cuerpo en metal. Acabados: blanco/blanco, negro/blanco, chocolate/blanco.**









WALL/CEILING **REFLEXIO**

STILNOVO 2023/24



1. Reflexio Ø46



96

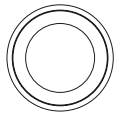

Ø462

Dimming kits

KIT0080 / CASAMBI
PH-CUT / 1 art / in

KIT0026
PH-CUT / 1-3 art

2. Reflexio Ø65



96

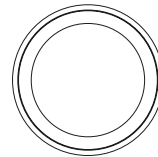

Ø654

Dimming kits

KIT0080 / CASAMBI
PH-CUT / 1 art / in

KIT0026
PH-CUT / 1-2 art

MOD	CODE	FINISH	SOURCE	INPUT	DIMMING	CCT (K)	LUMEN	CRI	IP	OPTICS
1	8530	WH WH	TopLED 35W	220-240V	Phase-cut	3000	3430	90	40	Diffused
	8531	BB WH	TopLED 35W	220-240V	Phase-cut	3000	3430	90	40	Diffused
	8534	CB WH	TopLED 35W	220-240V	Phase-cut	3000	3430	90	40	Diffused
2	8532	WH WH	TopLED 48W	220-240V	Phase-cut	3000	4778	90	40	Diffused
	8533	BB WH	TopLED 48W	220-240V	Phase-cut	3000	4778	90	40	Diffused
	8535	CB WH	TopLED 48W	220-240V	Phase-cut	3000	4778	90	40	Diffused

Other versions: suspension, p. 224.

Saturn

2014

Stilnovo

The ceiling-mounted Saturn is a striking luminous ring. The opaline diffuser, available in two diameters, emits uniform and high-performance ambient lighting that makes it ideal for the large spaces of modern architecture. The wall-mounted version, thanks to its “sharp-turning” geometry, is the solution for single compositions or dynamic series.

• **Polyethylene diffuser, metal mounting. Finish: white.**

Le plafonnier Saturn est un imposant anneau de lumière. Le diffuseur opalin, disponible en deux diamètres, émet une lumière d’ambiance uniforme et performante qui le rend idéal dans les grands espaces de l’architecture contemporaine. La version murale, grâce à sa géométrie en « anneau », est la solution pour les compositions uniques ou les séries dynamiques.

• **Diffuseur en polyéthylène, cadre en métal. Finition : blanc.**

Saturn de techo es un imponente anillo luminoso. El difusor opalino, disponible en dos diámetros, emana una luz ambiental uniforme y de alto rendimiento que lo hace ideal para grandes espacios de arquitectura contemporánea. La versión de pared, gracias a su geometría en horquilla, es la solución para composiciones individuales o en series dinámicas.

• **Difusor en polietileno, estructura en metal. Acabado: blanco.**







1. Saturn ceiling Ø76



Dimming kits

 **KIT0079** / CASAMBI
DALI / 1 art / out

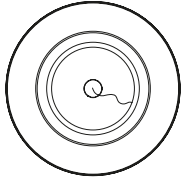
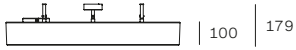

Ø757

2. Saturn ceiling Ø115



Dimming kits

 **KIT0079** / CASAMBI
DALI / 1 art / out

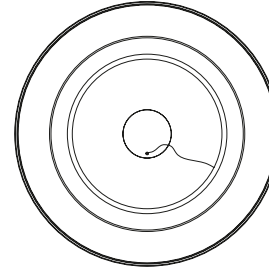
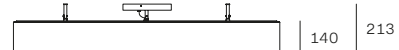

Ø1150

MOD	CODE	FINISH	SOURCE	INPUT	DIMMING	CCT (K)	LUMEN	CRI	IP	OPTICS
1	7653	WH	TopLED 33W	220-240V	DALI Push	3000	3686	90	40	Diffused
	7653N	WH	TopLED 33W	220-240V	DALI Push	4000	4048	90	40	Diffused
2	7651	WH	TopLED 98W	220-240V	DALI Push	3000	13961	90	40	Diffused
	7651N	WH	TopLED 98W	220-240V	DALI Push	4000	14566	90	40	Diffused

Other versions: suspension, p. 236.

Tablet

2014

Mirco Crosatto

Tablet is a family of minimalistic lamps with adjustable light. A thin, rectangular frame houses the mobile light sources which, thanks to the almost complete rotation on its own axis, allows the orientation of direct, indirect or combined beams of light.

• **Aluminium body, opaline polycarbonate diffuser.**
Finishes: white, black.

Tablet est une famille de lampes minimalistes à lumière directionnelle. Dans un fin cadre rectangulaire sont encadrées les sources mobiles qui, grâce à la rotation presque complète sur son axe, permettent l'orientation de faisceaux lumineux directs, indirects ou combinés.

• **Corps en aluminium, diffuseur en polycarbonate opale. Finitions : blanc, noir.**

Tablet es una familia de lámparas minimalistas con luz direccional. Las fuentes de luz en movimiento están enmarcadas en un fino marco rectangular que, gracias a la rotación casi completa sobre su eje, permite la orientación de haces de luz directa, indirecta o combinada.

• **Cuerpo en aluminio, difusor en policarbonato opalino. Acabados: blanco, negro.**

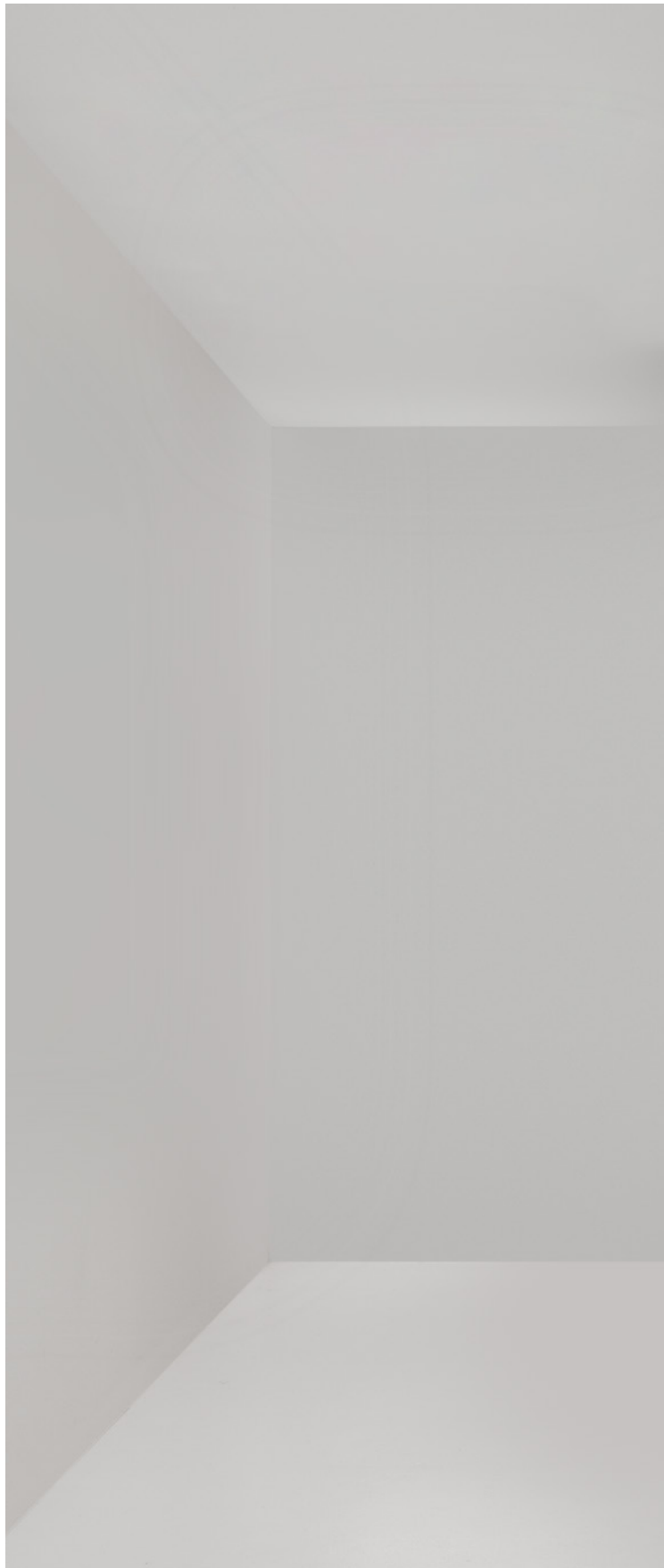





1. Tablet wall single L24

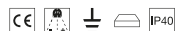

Cover for instl. hole:

KIT81 for 7601
KIT0042 for 7609

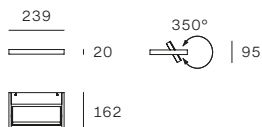

2. Tablet wall single L42

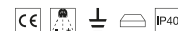

Cover for instl. hole:

KIT82 for 7602
KIT0043 for 7610

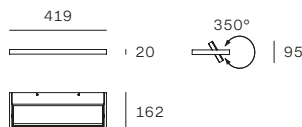

3. Tablet wall single L66

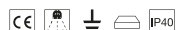

Cover for instl. hole:

KIT83 for 7604
KIT0044 for 7611

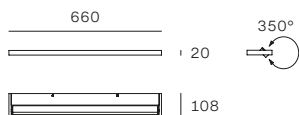

4. Tablet wall single L96



Cover for instl. hole:

KIT84 for 7605
KIT0045 for 7612

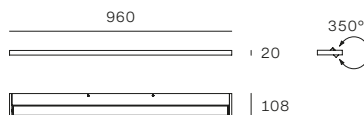

5. Tablet wall double L36

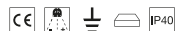

Cover for instl. hole:

KIT0046 for 7606
KIT0047 for 7613

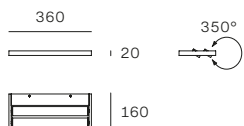

6. Tablet wall double L66

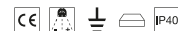

Cover for instl. hole:

KIT83 for 7607
KIT0044 for 7614

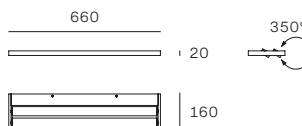

MOD	CODE	FINISH	SOURCE	INPUT	DIMMING	CCT (K)	LUMEN	CRI	IP	OPTICS
1	7601	WH	TopLED 15W	220-240V	No	3000	1826	80	40	Diffused
	7609	BB	TopLED 15W	220-240V	No	3000	1826	80	40	Diffused
2	7602	WH	TopLED 31W	220-240V	No	3000	3651	80	40	Diffused
	7610	BB	TopLED 31W	220-240V	No	3000	3651	80	40	Diffused
3	7604	WH	TopLED 21W	220-240V	No	3000	2360	80	40	Diffused
	7611	BB	TopLED 21W	220-240V	No	3000	2360	80	40	Diffused
4	7605	WH	TopLED 32W	220-240V	No	3000	3158	80	40	Diffused
	7612	BB	TopLED 32W	220-240V	No	3000	3158	80	40	Diffused
5	7606	WH	TopLED 22W	220-240V	No	3000	2360	80	40	Diffused
	7613	BB	TopLED 22W	220-240V	No	3000	2360	80	40	Diffused
6	7607	WH	TopLED 45W	220-240V	No	3000	4720	80	40	Diffused
	7614	BB	TopLED 45W	220-240V	No	3000	4720	80	40	Diffused

Other versions: floor, p. 130; suspension, p. 246.

Triedro

1970

Joe Colombo

Triedro is reminiscent of lighting from a photo shoot. Housing a silver-domed LED bulb, the lampshade is comprised of three contoured and bent metal parts in order to reflect the light downward, without creating glare. The flexibility in positioning is guaranteed by the supporting double joint for rotation and inclination of the light source into any position. In the clamp version, it secures easily to suit any needs.

• **Metal lampshade, body and bulb holder. Finish: white/black.**

Triedro évoque les lampes de scène des décors photographiques. L'abat-jour, contenant une ampoule LED à dôme argenté, est en métal façonné et plié en trois parties, de manière à réfléchir la lumière sans éblouir. Une grande flexibilité de mouvement est garantie par la double articulation principale, qui permet la rotation et l'inclinaison de la source lumineuse. Dans la version à pinces, il peut être facilement fixé pour chaque besoin.

• **Abat-jour, corps et support de lampe en métal. Finitions : blanc/noir.**

Triedro recrea las lámparas de escena de los sets fotográficos. La pantalla, que contiene una bombilla LED de cúpula plateada, es de metal conformado y plegado en tres partes, a fin de reflejar la luz sin deslumbrar. Una amplia flexibilidad de movimiento está garantizada por la articulación de doble codo, que permite la rotación e inclinación de la fuente de luz. En la versión de abrazadera se fija fácilmente para cualquier necesidad.

• **Pantalla, cuerpo y portalámparas en metal. Acabado: blanco/negro.**

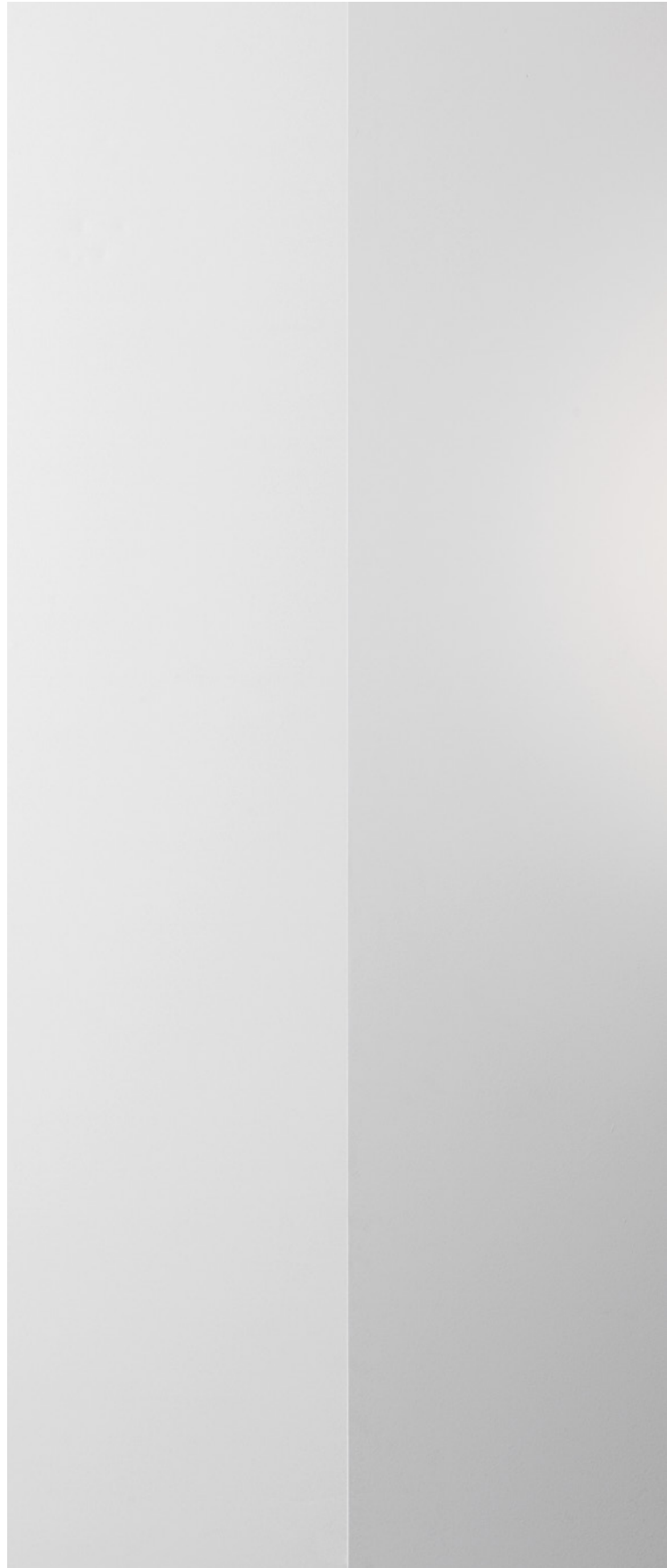





1. Triedro clamp



Included bulb
Classic A Mirror
LED Bulb E27 7W

227



2. Triedro wall

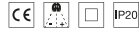

Included bulb
Classic A Mirror
LED Bulb E27 7W

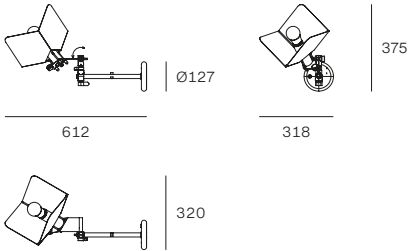

MOD	CODE	FINISH	SOURCE	INPUT	DIMMING	CCT (K)	LUMEN	CRI	IP	OPTICS
1	8992	BB WH	1xE27 7W	220-240V	No	2700	650	≥80	20	Diffused
2	8993	BB WH	1xE27 7W	220-240V	No	2700	650	≥80	20	Diffused

Other versions: floor, p. 138; suspension, p. 256.

Xilema

2014

Edin Dedovic

The elegant lightness of Xilema houses a Wall-Washer toppled light source which, be it vertical or horizontal, diffuses comfortable, indirect ambient illumination. Alongside the linear versions is a more intricate version reminiscent of xilema, the plant tissue that transports water from the roots to the stems and leaves.

• **Aluminium body, PMMA diffuser. Finishes: white, polished aluminium.**

L'élégante légèreté de Xilema accueille une source topLED WallWasher qui, verticalement ou horizontalement, diffuse une confortable lumière ambiante indirecte. Les versions linéaires sont flanquées d'une variante complexe qui rappelle le xylème, le tissu qui, dans les plantes, conduit la sève des racines aux feuilles.

• **Corps en aluminium, diffuseur en PMMA. Finitions : blanc, aluminium brillant.**

La elegante ligereza de Xilema acoge una fuente WallWasher topLED que, vertical u horizontalmente, difunde una confortable luz ambiental indirecta. Las versiones lineales están flanqueadas por una variante compleja que recuerda el xilema, el tejido vegetal que conduce la savia desde las raíces hasta las hojas.

• **Cuerpo en aluminio, difusor en PMMA. Acabados: blanco, aluminio brillante.**





1. Xilema wall L79

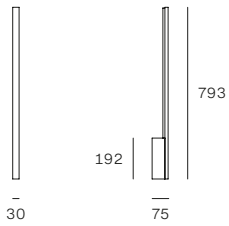

2. Xilema wall L180

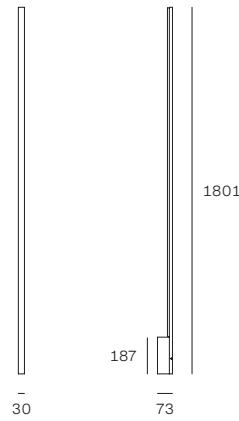

3. Xilema wall/ceiling L149

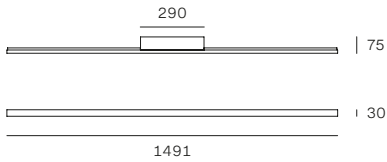
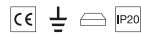

4. Xilema wall/ceiling L160

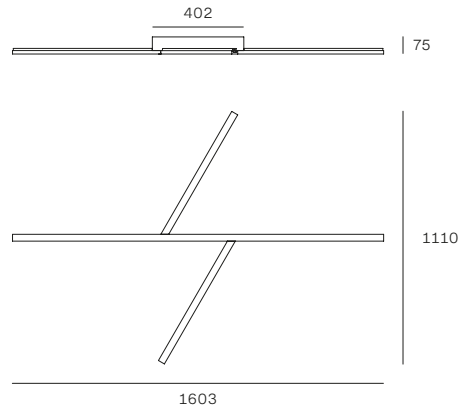
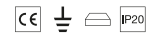

MOD	CODE	FINISH	SOURCE	INPUT	DIMMING	CCT (K)	LUMEN	CRI	IP	OPTICS
1	7765	WH	TopLED 17W	220-240V	No	3000	1703	90	20	Double asym.
	7766	PA	TopLED 17W	220-240V	No	3000	1703	90	20	Double asym.
2	7777	WH	TopLED 25W	220-240V	Touch	3000	2556	90	20	Double asym.
	7778	PA	TopLED 25W	220-240V	Touch	3000	2556	90	20	Double asym.
3	7767	WH	TopLED 34W	220-240V	No	3000	3407	90	20	Double asym.
	7768	PA	TopLED 34W	220-240V	No	3000	3407	90	20	Double asym.
4	7769	WH	TopLED 47W	220-240V	No	3000	4956	90	20	Double asym.
	7770	PA	TopLED 47W	220-240V	No	3000	4956	90	20	Double asym.

Other versions: suspension, p. 260.

Xilema system

2019

Edin Dedovic

The Xilema System is characterised by high modularity. The lighting structures bear a WallWasher topLED light source, being inter-connected thanks to specific adaptors that allow variable pathways to be created on vertical, horizontal and sloped surfaces. This renders it possible to design lines of continuous illumination, able to adapt to any architectural setting.

• **Lighting modules, junctions, ends and power supply modules in aluminium, diffuser in PMMA. Finishes: white, polished aluminium.**

Le système Xilema se distingue pour sa grande modularité. Les luminaires sont équipés d'une source topLED WallWasher et peuvent être reliés entre eux grâce à des raccords spéciaux qui permettent de créer des trajectoires variables sur des surfaces verticales, horizontales et inclinées. De cette façon, il est possible de dessiner des lignes de lumière continues, capables de s'adapter à tout contexte architectural.

• **Modules d'éclairage, jonctions, embouts et modules d'alimentation en aluminium, diffuseur en PMMA. Finitions : blanc, aluminium brillant.**

Xilema System se caracteriza por una alta modularidad. Los cuerpos de iluminación están equipados con una fuente topLED Wall Washer y se pueden conectar entre sí gracias a herrajes especiales que permiten crear recorridos variables sobre superficies verticales, horizontales e inclinadas. Así es posible trazar líneas continuas de luz, capaces de adaptarse a cualquier contexto arquitectónico.

• **Módulos de iluminación, juntas, elementos finales y módulos de alimentación en aluminio, difusor en PMMA. Acabados: blanco, aluminio brillante.**











1. Linear light

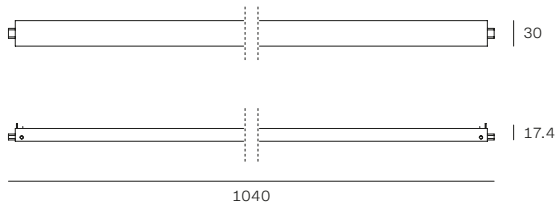

Head or Central power multi-supply required (*)

2. Electrified planar joint

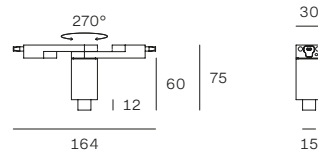

3. Electrified angular joint

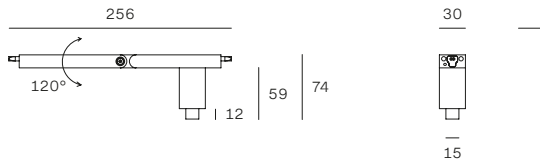

4. End fixing

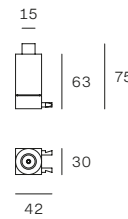

5. Head power multi-supply

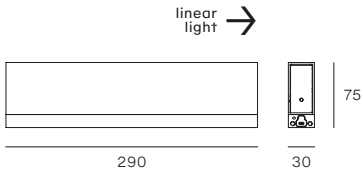

Max 10 linear lights connectable

6. Central power multi-supply

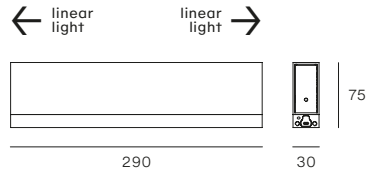

Max 10 linear lights connectable

MOD	CODE	FINISH	SOURCE	INPUT	DIMMING	CCT (K)	LUMEN	CRI	IP	OPTICS
1	9100	WH	TopLED 9.5W	48V	DALI Push*	3000	1040	90	20	Double asym.
	9110	PA	TopLED 9.5W	48V	DALI Push*	3000	1040	90	20	Double asym.
2	9103	WH	-	-	-	-	-	-	20	-
	9113	PA	-	-	-	-	-	-	20	-
3	9104	WH	-	-	-	-	-	-	20	-
	9114	PA	-	-	-	-	-	-	20	-
4	9105	WH	-	-	-	-	-	-	20	-
	9115	PA	-	-	-	-	-	-	20	-
5	9101	WH	-	220-240V	DALI Push	-	-	-	20	-
	9111	PA	-	220-240V	DALI Push	-	-	-	20	-
6	9102	WH	-	220-240V	DALI Push	-	-	-	20	-
	9112	PA	-	220-240V	DALI Push	-	-	-	20	-

*Head or central power multi-supply required.

1Night/2Nights

2016

Davide Oppizzi

1Night offers refined illumination. The powerLED technology is housed in an elegant cylinder that can be rotated and directed as desired, being perfect bedside or in a reading nook. In the 2Nights version, the structure contains coloured texture filters to act as a projector, adorning the wall with multiple light and shadow effects.

• **Body and directable cylinder in aluminium. Finishes: white, black, white/galvanic rose gold, black/galvanic gold.**

1Night est un élégant objet d'éclairage. La technologie powerLED est logée dans un élégant cylindre qui peut être tourné et orienté à volonté, idéal pour une utilisation près de la tête de lit ou dans un coin lecture. Dans la version 2Nights, la structure s'articule pour accueillir des filtres aux textures colorées : la source fonctionne comme un projecteur, décorant le mur de multiples effets d'ombre et de lumière.

• **Corps et cylindre orientable en aluminium. Finitions : blanc, noir, blanc/galvanisé or rose, noir/galvanisé or.**

1Night es un objeto luminoso refinado. La tecnología powerLED está alojada en un elegante cilindro que se puede girar y ajustar como se desee, ideal cerca de la cabecera de la cama o para un rincón de lectura. En la variante 2Nights, la estructura se articula para alojar filtros con texturas de colores: la fuente luminosa actúa como proyector, decorando la pared con múltiples efectos de luz y sombra.

• **Cuerpo y cilindro orientable en aluminio. Acabados: blanco, negro, blanco/galvánico oro rosa, negro/galvánico oro.**









WALL/CEILING **1NIGHT/2NIGHTS**

STILNOVO 2023/24



1. 2Nights

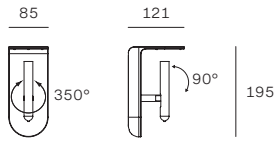

Amber, transparent and opal filters included:



2. 2Nights with switch

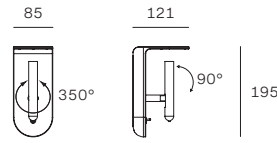

Amber, transparent and opal filters included:



3. 1Night with switch

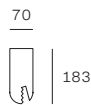
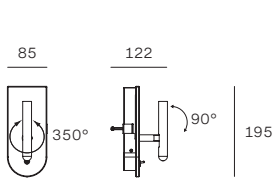

2Nights optional filters



Fire
KIT0035 (white)
KIT0036 (black)



Tree
KIT0055 (white)
KIT0056 (black)

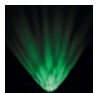

Water
KIT0057 (white)
KIT0058 (black)

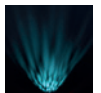

Ø74

MOD	CODE	FINISH	SOURCE	INPUT	DIMMING	CCT (K)	LUMEN	CRI	IP	OPTICS
1	7975	WH WH	TopLED 4W	220-240V	No	3000	230	90	20	Wide Flood
	7977	BB BB	TopLED 4W	220-240V	No	3000	230	90	20	Wide Flood
	7942	WH RG	TopLED 4W	220-240V	No	3000	230	90	20	Wide Flood
	7944	BB AU	TopLED 4W	220-240V	No	3000	230	90	20	Wide Flood
2	7976	WH WH	TopLED 4W	220-240V	No	3000	230	90	20	Wide Flood
	7978	BB BB	TopLED 4W	220-240V	No	3000	230	90	20	Wide Flood
	7943	WH RG	TopLED 4W	220-240V	No	3000	230	90	20	Wide Flood
	7945	BB AU	TopLED 4W	220-240V	No	3000	230	90	20	Wide Flood
3	8636	WH WH	TopLED 4W	220-240V	No	3000	230	90	20	Wide Flood
	8637	BB BB	TopLED 4W	220-240V	No	3000	230	90	20	Wide Flood
	8639	WH RG	TopLED 4W	220-240V	No	3000	230	90	20	Wide Flood
	8638	BB AU	TopLED 4W	220-240V	No	3000	230	90	20	Wide Flood

Designers



Danilo & Corrado Aroldi

Periscopio

pp. 76, 126



Shigeaki Asahara

Bascula

pp. 146

Luna

112, 190



Gae Aulenti

Minibox

pp. 66, 324

Trepiù

250

© Archivio Gae Aulenti



Achille & Pier Giacomo Castiglioni

Saliscendi

p. 228

© Fondazione Achille Castiglioni



© Piero Castiglioni

Livio Castiglioni

Trepù p. 250

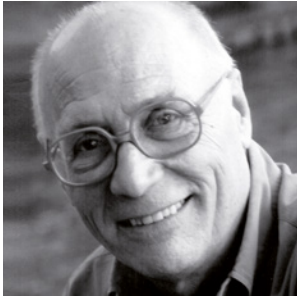

© Piero Castiglioni

Piero Castiglioni

Minibox pp. 66, 324



© Ignazia Favata / Studio Joe Colombo

Joe Colombo

Minitopo pp. 70
Topo 80, 134
Triedro 256, 356



Mirco Crosatto
Stilnovo

Demí pp. 158, 272
Demí Moon 94
Diphy 98, 164, 276
La Mariée 46, 182
Lama 50, 312
Mr Magoo 116
Reflexio 224, 342
Tablet 130, 246, 352



© CASVA - Centro di Alti Studi sulle Arti Visive

Jonathan De Pas
Donato D'Urbino
Paolo Lomazzi

Fante	pp. 24, 284,
Lampiatto	54, 186, 316



Edin Dedovic
Stilnovo

Kimia	pp. 108,
Xilema	260, 360
Xilema system	352



© Giovanni Luigi Gorgoni

Giovanni Luigi Gorgoni

Buonanotte	p. 20
------------	-------

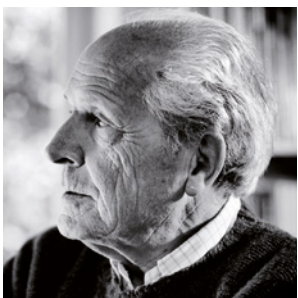

© Antonio Macchi Cassia

Antonio Macchi Cassia

Bugia	p. 16, 266
Gravita	28
Gravitino 541	36, 298



Davide Oppizzi

1Night/2Nights

pp. 370

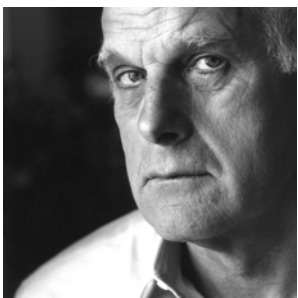

Richard Sapper

Halley

pp. 40

© Richard Sapper Archives



Brian Sironi

Inbilico

p. 306

© Benvenuto Saba



Studio Nizzoli Associati

Alessandro Mendini
Giuseppe Mario Oliveri
Paolo Viola

Goletta

p. 294

© Archivio
Alessandro
Mendini.
Ph. Young
Hee Cha

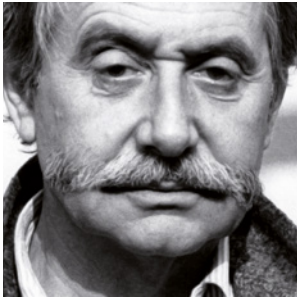

© Barbara Radice

Ettore Sottsass Jr

Valigia p. 86



Pio & Tito Toso

Honey	pp. 178, 302
Oxygen	212, 332
Quad	218, 338



Stilnovo

Campana	pp. 152
Dynamic	280
Galassia	104, 170, 288
Megafono	58, 194, 320
Mongolfier	200
Opti-line	208
Saturn	236, 348
Sputnik	240

Awards



ADI Design Index

Selected

2022 Soliscendi



Compasso d'oro

Honourable Mention

2018 Diphy



iF Product Design Award

Winner

2018 Reflexio



Red Dot Design Award

Winner

2011 Lama

2015 Mr Magoo

2016 2Nights

2017 Oxygen

2017 Diphy

2018 Tablet floor

2019 Demí

Code index

CODE	PRODUCT	PAGE
7104	Lama	315
7112	Lama	53
7113	Lama	53
7137	Lama	315
7601	Tablet	355
7602	Tablet	355
7604	Tablet	355
7605	Tablet	355
7606	Tablet	355
7607	Tablet	355
7609	Tablet	355
7610	Tablet	355
7611	Tablet	355
7612	Tablet	355
7613	Tablet	355
7614	Tablet	355
7650	Saturn	239
7650N	Saturn	239
7651	Saturn	351
7651N	Saturn	351
7652	Saturn	239
7652N	Saturn	239
7653	Saturn	351
7653N	Saturn	351
7750	Quad	341
7753	Quad	341
7765	Xilema	363
7766	Xilema	363
7767	Xilema	363
7768	Xilema	363

CODE	PRODUCT	PAGE
7769	Xilema	363
7770	Xilema	363
7773	Xilema	263
7774	Xilema	263
7777	Xilema	363
7778	Xilema	363
7785	Dynamic	283
7786	Dynamic	283
7787	Dynamic	283
7788	Mr. Magoo	207
7788N	Mr. Magoo	207
7789	Mr. Magoo	331
7789N	Mr. Magoo	331
7790	Mr. Magoo	207
7792	Mr. Magoo	331
7942	2Nights	375
7943	2Nights	375
7944	2Nights	375
7945	2Nights	375
7975	2Nights	375
7976	2Nights	375
7977	2Nights	375
7978	2Nights	375
8005	Mr. Magoo	207
8005N	Mr. Magoo	207
8006	Mr. Magoo	331
8006N	Mr. Magoo	331
8007	Mr. Magoo	207
8007N	Mr. Magoo	207
8008	Mr. Magoo	331

CODE	PRODUCT	PAGE
8008N	Mr. Magoo	331
8009	Mr. Magoo	119
8037	Opti-Line	211
8038	Opti-Line	211
8081	Oxygen	337
8082	Oxygen	337
8083	Oxygen	337
8084	Oxygen	337
8085	Oxygen	337
8086	Oxygen	337
8087	Oxygen	337
8088	Oxygen	337
8089	Oxygen	217
8090	Oxygen	217
8091	Oxygen	217
8092	Oxygen	217
8093	Oxygen	217
8094	Oxygen	217
8095	Oxygen	217
8096	Oxygen	217
8097	Oxygen	125
8098	Oxygen	125
8099	Oxygen	125
8100	Oxygen	125
8101	Oxygen	125
8102	Oxygen	125
8103	Oxygen	125
8104	Oxygen	125
8110	Quad	222
8111	Quad	222

CODE	PRODUCT	PAGE
8112	Quad	223
8113	Quad	223
8135	Mr. Magoo	207
8136	Mr. Magoo	331
8137	Mr. Magoo	207
8138	Mr. Magoo	331
8140	Mongolfier	203
8141	Mongolfier	203
8142	Mongolfier	203
8144	Mongolfier	203
8145	Mongolfier	203
8146	Mongolfier	203
8147	Mongolfier	203
8148	Mongolfier	203
8149	Mongolfier	203
8163	Diphy	279
8163M	Diphy	279
8164	Diphy	279
8164M	Diphy	279
8165	Diphy	103
8165M	Diphy	103
8166	Diphy	279
8166M	Diphy	279
8167	Diphy	279
8167M	Diphy	279
8168	Diphy	169
8168M	Diphy	169
8169	Diphy	169
8169M	Diphy	169
8170	Diphy	169

CODE	PRODUCT	PAGE
8170M	Diphy	169
8171	Diphy	169
8171M	Diphy	169
8172	Diphy	169
8172M	Diphy	169
8173	Diphy	169
8173M	Diphy	169
8174	Diphy	169
8174M	Diphy	169
8185	Oxygen	337
8186	Oxygen	337
8187	Oxygen	337
8188	Oxygen	337
8450	Tablet	249
8451	Tablet	249
8452	Tablet	133
8453	Tablet	133
8475	Tablet	249
8476	Tablet	249
8490	Opti-Line	211
8491	Opti-Line	211
8495	Oxygen	337
8496	Oxygen	337
8497	Oxygen	337
8498	Oxygen	337
8520	Quad	222
8521	Quad	222
8522	Quad	222
8523	Quad	222
8524	Quad	223

CODE	PRODUCT	PAGE
8525	Quad	223
8526	Quad	222
8527	Quad	222
8530	Reflexio	347
8531	Reflexio	347
8532	Reflexio	347
8533	Reflexio	347
8534	Reflexio	347
8535	Reflexio	347
8536	Reflexio	227
8537	Reflexio	227
8538	Reflexio	227
8539	Reflexio	227
8540	Reflexio	227
8541	Reflexio	227
8545	Kimia	111
8546	Kimia	111
8624	La Mariée	185
8625	La Mariée	185
8626	La Mariée	185
8627	La Mariée	185
8628	La Mariée	49
8629	La Mariée	49
8630	La Mariée	49
8631	La Mariée	49
8636	1Night	375
8637	1Night	375
8638	1Night	375
8639	1Night	375
8680	Honey	181

CODE	PRODUCT	PAGE
8682	Honey	181
8684	Honey	181
8686	Honey	181
8688	Honey	305
8690	Honey	305
8890	Demí	163
8890M	Demí	163
8891	Demí	163
8891M	Demí	163
8892	Demí	163
8892M	Demí	163
8893	Demí	275
8893M	Demí	275
8894	Demí	275
8894M	Demí	275
8895	Demí	275
8895M	Demí	275
8960	Valigia	91
8961	Buonanotte	23
8962	Buonanotte	23
8963	Buonanotte	23
8964	Buonanotte	23
8966	Fante	27
8967	Fante	287
8968	Fante	27
8969	Fante	287
8971	Lampiatto	319
8972	Lampiatto	319
8973	Lampiatto	319
8981	Lampiatto	189

CODE	PRODUCT	PAGE
8982	Lampiatto	189
8983	Lampiatto	189
8984	Lampiatto	189
8985	Lampiatto	189
8987	Lampiatto	189
8988	Lampiatto	189
8989	Lampiatto	189
8990	Lampiatto	189
8991	Lampiatto	189
8992	Triedro	359
8993	Triedro	359
8994	Triedro	143
8995	Triedro	259
9055	Periscopio	79
9056	Periscopio	79
9057	Periscopio	79
9058	Periscopio	129
9059	Periscopio	129
9060	Periscopio	129
9061	Periscopio	129
9062	Periscopio	129
9063	Periscopio	129
9064	Minitopo	75
9065	Minitopo	75
9066	Minitopo	75
9067	Minitopo	75
9068	Minitopo	75
9069	Minitopo	75
9070	Minitopo	75
9071	Topo	85

CODE	PRODUCT	PAGE
9072	Topo	85
9073	Topo	85
9074	Topo	85
9075	Topo	85
9076	Topo	85
9077	Topo	85
9078	Topo	85
9079	Topo	85
9080	Topo	85
9081	Topo	137
9082	Topo	137
9083	Topo	137
9084	Topo	137
9085	Topo	137
9090	Diphy	169
9090M	Diphy	169
9100	Xilema	369
9101	Xilema	369
9102	Xilema	369
9103	Xilema	369
9104	Xilema	369
9105	Xilema	369
9110	Xilema	369
9111	Xilema	369
9112	Xilema	369
9113	Xilema	369
9114	Xilema	369
9115	Xilema	369
9275	Minibox	327
9276	Minibox	327

CODE	PRODUCT	PAGE
9277	Minibox	327
9278	Minibox	327
9279	Minibox	327
9285	Minibox	69
9286	Minibox	69
9287	Minibox	69
9288	Minibox	69
9289	Minibox	69
9300	Campana	157
9301	Campana	157
9302	Campana	157
9305	Trepiù	255
9306	Trepiù	255
9307	Trepiù	255
9308	Trepiù	255
9310	Saliscendi	235
9311	Saliscendi	235
9312	Saliscendi	235
9555	Galassia	177
9556	Galassia	177
9557	Galassia	293
9558	Galassia	293
9559	Galassia	293
9560	Galassia	107
9566	Megafono	199
9567	Megafono	199
9568	Megafono	199
9569	Megafono	199
9570	Megafono	323
9571	Megafono	323

CODE	PRODUCT	PAGE
9572	Megafono	323
9573	Megafono	323
9574	Megafono	61
9575	Megafono	61
9576	Megafono	199
9577	Megafono	199
9585	Gravita	35
9586	Halley	45
9586M	Halley	45
9587	Halley	45
9587M	Halley	45
9590	Sputnik	245
9591	Sputnik	245
9592	Sputnik	245
9680	Bugia	19
9681	Bugia	19
9682	Bugia	19
9683	Bugia	19
9684	Bugia	19
9686	Bugia	271
9687	Bugia	271
9688	Bugia	271
9689	Bugia	271
9690	Bugia	271
9692	Bugia	271
9693	Bugia	271
9694	Bugia	271
9695	Bugia	271
9696	Bugia	271
9698	Meta	65

CODE	PRODUCT	PAGE
9699	Meta	65
9700	Meta	65
9701	Meta	65
9703	Luna	193
9703M	Luna	193
9705	Luna	193
9705M	Luna	193
9707	Luna	115
9707M	Luna	115
9709	Luna	115
9709M	Luna	115
9711	Gravitino 541	39
9712	Gravitino 541	39
9713	Gravitino 541	39
9714	Gravitino 541	39
9715	Gravitino 541	39
9716	Gravitino 541	39
9717	Gravitino 541	301
9718	Gravitino 541	301
9719	Gravitino 541	301
9720	Gravitino 541	301
9721	Gravitino 541	301
9722	Gravitino 541	301
9733	Goletta	297
9734	Goletta	297
9735	Goletta	297
9736	Goletta	297
9737	Goletta	297
9738	Goletta	297
9775	Demí Moon	97

CODE	PRODUCT	PAGE
9775M	Demí Moon	97
9776	Demí Moon	97
9776M	Demí Moon	97
9780	Inbilico	311
9780M	Inbilico	311
9781	Inbilico	311
9781M	Inbilico	311
9782	Inbilico	311
9782M	Inbilico	311
9783	Inbilico	311
9783M	Inbilico	311
CZ001CBZMDD	Bascula	151
CZ001CBZWDD	Bascula	151
CZ001CGGMDD	Bascula	151
CZ001CGGWDD	Bascula	151
CZ001CKGMDD	Bascula	151
CZ001CKGWDD	Bascula	151
CZ001CKWMDD	Bascula	151
CZ001CKWWDD	Bascula	151
CZ001CRRMDD	Bascula	151
CZ001CRRWDD	Bascula	151
CZ001CWHMDD	Bascula	151
CZ001CWHWDD	Bascula	151
KIT0026	Phase-cut dimmer	163, 168, 181, 203, 207, 211, 222, 227, 249, 279, 301, 305, 311, 327, 331, 332, 341, 347, 375
KIT0035	2Nights gobo filter	375
KIT0036	2Nights gobo filter	375
KIT0042	Tablet fixing bracket	355

CODE	PRODUCT	PAGE
KIT0043	Tablet fixing bracket	355
KIT0044	Tablet fixing bracket	355
KIT0045	Tablet fixing bracket	355
KIT0046	Tablet fixing bracket	355
KIT0047	Tablet fixing bracket	355
KIT0055	2Nights gobo filter	375
KIT0056	2Nights gobo filter	375
KIT0057	2Nights gobo filter	375
KIT0058	2Nights gobo filter	375
KIT0079	Casambi DALI dimmer	151, 157, 163, 168, 169, 193, 207, 211, 217, 222, 223, 235, 239, 255, 275, 279, 331, 337, 351
KIT0080	Casambi Phase cut dimmer	163, 168, 181, 203, 207, 211, 222, 227, 249, 279, 301, 305, 311, 327, 331, 332, 341, 347, 375
KIT0111	Goletta modular kit	297
KIT81	Tablet fixing bracket	355
KIT82	Tablet fixing bracket	355
KIT83	Tablet fixing bracket	355
KIT84	Tablet fixing bracket	355

Finishes

Varnished metal

	WH	WH	LY	GG	BB	CB	CF	IV	RU	RR
	White RAL 9016 polished	White RAL 9003 matt	Light Gray RAL 9002 polished	Gray RAL 7012 polish./matt	Black RAL 9005 polish./matt	Chocolate RAL 8019 matt	Coffee beige RAL 1001 polished	Ivory RAL 1015 polished	Ruby red RAL 3003 polished	Flame red RAL 3000 polished
Bascula		1		1						
Bugia	1				1					1
Buonanotte	1									1
Campana			1							1
Demí		1								
Demí Moon		1			1					
Diphy		1								
Dynamic										
Fante		2								
Galassia										
Goletta	2									
Gravita										
Gravitino 541	1			1	1					
Halley										
Honey		1								
Inbilico		1 2			2					
Kimia		1			1					
La Mariée		1 2			2					
Lama		1			1					
Lampiatto	1 2				1					
Luna		1			1					
Megafono	2							2		
Meta	1	2			1 2					
Minibox	1				1		1			1
Minitopo	1				1 2					1
Mongolfier					1					
Mr. Magoo		1								
Opti-Line		1								
Oxygen		1								
Periscopio	1				1					
Quad		1			1					
Reflexio		1 2			1	1				
Saliscendi	2		1		2				1	
Saturn										
Sputnik	2				2			2		2
Tablet		1			1					
Topo	1				1 2					
Trepìù	1				2					
Triedro	1				2					
Valigia					○					1
Xilema/X. system		1								
1Night/2Nights		1 2			1 2					

- ① Body lamp finish
- ② Component visible finish
- Diffuser / lampshade finish

Varnished metal										Marble
RI	RV	YY	GR	GR	GR	BL	AZ	BZ	NK	
Iconic red RAL 3020 polished	Vermilion red RAL 2002 polished	Yellow RAL 1003 polished	Leaf green RAL 6002 polished	Mint green RAL 6029 polished	Grass green RAL 6024 polished	Blue RAL 5011 polished	Azure RAL 5024 polished	Bronze	Nichel	Carrara marble
①								②	②	
		①		①						
		①				①				
										②
①		①								
	①	①		①						
①			①							
① ②				①						
①										
					①					
		②		②		②	②			
① ②				①						
		②								























Finishes

	Finished metal		Anodized metal		Galvanized metal							TR
	PA	HA	AM	AK	BC	CH	RG	AU	BZ	HG	HK	
	Polished aluminum	Brushed aluminum	Anodized aluminum	Black anodized aluminum	Black nickel	Chrome	Rose gold	Gold	Brushed bronze	Brushed gold	Brushed black nickel	Transp. PMMA
Bascula									1 2		2	
Bugia												
Buonanotte												
Campana		1										
Demí												○
Demí Moon												○
Diphy												○
Dynamic												
Fante												
Galassia								1				
Goletta	2											
Gravita				1		2						
Gravitino 541												
Halley			1	1								
Honey												
Inbilico										2	2	
Kimia												
La Mariée					1		1	1				
Lama												
Lampiatto												
Luna						2		2				
Megafono								1				
Meta										1		
Minibox												
Minitopo						1 2		1				
Mongolfier					1		1					
Mr. Magoo												
Opti-Line		1										○
Oxygen												
Periscopio												
Quad												
Reflexio												
Saliscendi												
Saturn												
Sputnik								1				
Tablet												
Topo						1						
Trepiù						1						
Triedro						2						
Valigia												
Xilema/X. system	1											
1Night/2Nights							2	2				

- ① Body lamp finish
- ② Component visible finish
- Diffuser / lampshade finish

Plastic & rubber									Glass				
WH	WH	BB	BB	RR	YY	AZ	WH	BB	RI RR	WH	SG	RG AU	TR
White polycarb./polyethyl.	White polyurethane	Black polyurethane	Black rubber	Brick red rubber	Yellow polyurethane	Azure polyurethane	White RAL 9003 ABS	Black RAL 9005 ABS/PMMA	Red RAL 3000/20 ABS/PMMA	White glass	Grey smoked glass	Gold / Rose glass	Transp. glass
			①	①						○			
							①	①	①	○			
○													○
											○	○	○
							①	①	①				
○										○			
	○	○	②		○	○							
○													

Symbols

	CE Marking		Installation hole
	Protection class (IEC 60529) against foreign bodies and water		C.V. Constant Voltage
	Directional light beam		Push DIM
	Power supply cable included (pendant or table lamps)		DALI
	Class I - IEC protection class		DALI / Push DIM
	Class II - IEC protection class		Phase-Cut
	Class III - IEC protection class		Touch dimmer
	Driver included		Touchless dimmer
	Driver not included		Warm Tune
	Indirect emission		Magnetic connection
	Double emission		
	% Emission up and down		

The lumens indicated refer to the light source emission. The connection diagrams for electronics articles are included in the technical documentation.

Les lumens indiqués se réfèrent à l'émission de la source lumineuse. Les schémas de branchement pour les articles électroniques sont disponibles à l'intérieur de la documentation technique.

Los lúmenes indicados se refieren a la emisión de la fuente luminosa. Los esquemas de conexión para los artículos de la electrónica están disponibles dentro de la documentación técnica.

Warranty & disclaimer

"Stilnovo by Linea Light Group" offers a 5-year warranty on its products against manufacturing defects, subject to filling in the activation form available at www.stilnovo.com. In the absence of activation, the statutory warranty remains valid.

All power supply, wiring and accessories used for product installation shall be original "Stilnovo by Linea Light Group" parts or approved by the company. The warranty will become void if non original or non approved parts are used. For more information, please visit our website www.stilnovo.com.

"Stilnovo by Linea Light Group" reserves the right, without any advance notice, to change the characteristics of their products, as well as the availability of the same at any time. No product, relative technical data, illustrations and information in the catalogue are binding for "Stilnovo by Linea Light Group". "Stilnovo by Linea Light Group" will not be held liable for any illustration, text and/or translation errors. More product characteristics are contained in the relative technical data sheets and instruction sheets. This catalogue is protected by copyright (law 22/04/1941 No. 633 and law 14/12/1942 No. 1485: this prohibits any reproduction, total or even partial).

All values indicated in the catalogue are measured values. There is a +/- 10% tolerance for the flow, CCT and power data.

"Stilnovo by Linea Light Group" offre une garantie de 5 ans sur ses produits pour vice de fabrication à condition d'avoir préalablement rempli le formulaire d'activation correspondant, disponible sur le site www.stilnovo.com. En cas de non-activation, la garantie prévue par la loi reste valable.

Les produits doivent impérativement être installés avec des alimentations, des câblages et des accessoires "Stilnovo by Linea Light Group", ou qui ont été approuvés par l'entreprise. L'utilisation d'accessoires non d'origine, ou non approuvés, entraîne la déchéance de toute garantie sur le produit. Pour tout renseignement complémentaire, consulter le site www.stilnovo.com.

"Stilnovo by Linea Light Group" se réserve le droit, à tout moment et sans préavis, de modifier les caractéristiques de ses produits et leur disponibilité. Tous les produits, données techniques, illustrations et informations du catalogue ne sont pas contractuels pour "Stilnovo by Linea Light Group". "Stilnovo by Linea Light Group" ne pourra être tenu responsable des éventuelles erreurs d'illustration, de texte et/ou de traduction. Les autres caractéristiques des produits sont décrites dans les fiches techniques et les notices d'instructions correspondantes. Ce catalogue est protégé par la loi sur les droits d'auteur (loi 22/04/1941 n° 633 et loi 14/12/1942 n° 1485 : toute reproduction totale ou partielle du présent catalogue est interdite). Toutes les valeurs indiquées dans ce catalogue sont des valeurs mesurées. Les données de flux, de CCT et de puissance sont soumises à des tolérances de +/- 10 %.

"Stilnovo by Linea Light Group" ofrece una garantía de 5 años para sus productos por vicios de fabricación previa cumplimentación del formulario correspondiente de activación, disponible en el sitio www.stilnovo.com. En caso de no activación, la garantía es la contemplada por la ley.

Los productos se han de instalar obligatoriamente con alimentaciones, cableados y accesorios originales de "Stilnovo by Linea Light Group" o, de otra forma, deben ser aprobados por la empresa misma. El uso de accesorios no originales, o no aprobados, anula todas las garantías del producto. Para más información, visite www.stilnovo.com.

"Stilnovo by Linea Light Group" se reserva el derecho de modificar, en cualquier momento sin previo aviso, las características de sus productos, así como la disponibilidad de los mismos. Todos los productos, sus datos técnicos, las ilustraciones y la información del catálogo no son vinculantes para "Stilnovo by Linea Light Group". "Stilnovo by Linea Light Group" no se hace responsable de los errores de las ilustraciones, los textos y/o la traducción. Pueden encontrarse características adicionales de los productos en las correspondientes hojas de datos e instrucciones. Este catálogo está protegido por la ley de derechos de autor (ley 22/04/1941 n° 633 y ley 14/12/1942 n° 1485: está prohibida toda reproducción total o parcial de este catálogo). Todos los valores reflejados en el catálogo son valores medidos. Los datos de flujo, CCT y potencia están sujetos a tolerancias de +/- 10 %.

Addresses

Headquarter

c/o Linea Light Srl
Via Della Fornace 59
31023 Castelminio di Resana TV
Italy
T +39 0423 7868
E info@stilnovo.com

Milan

Via Morimondo 26
int. 17/G
20143 Milano MI
Italy
T +39 02 36750915
E milano@linealight.com

Rome

c/o Linea Light Roma Srl
Via La Spezia, 34
00182 Roma
Italy
T +39 06 68589134
E info@linealightroma.com

France

c/o Linea Light France
Rue des Pays-Bas 12
68310 Wittelsheim
France
T +33 389 75 52 23
E info@linealight.fr

Germany

c/o Linea Light Deutschland
Aktienstraße 214
45473 Mülheim an der Ruhr
Germany
T +49 208 299979-0
E service@linealight.de

United Arab Emirates

c/o Linea Light GCC DMCC
P.O. Box 125902
Jumeirah Lake Towers JBC2
35th Floor Office 02
Dubai UAE
T +971 4 4218275
E info@linealight.ae

Qatar

Al Muntaza, C Ring Road,
Andalus petrol station
Building n.1, office 3 Po Box: 30459
Doha, Qatar
T +974 44785354
E naim.eldamaa@linealight.com

United Kingdom

c/o Linea Light UK Ltd
52 Upper Street
N10QH Islington London
United Kingdom
T +44 0203 6371983
E info@linealight-uk.com

China

c/o People and Objects CO. LTD
Room 118 BLDG. 20 No. 1-42
Lane 83
Hongxiang North
RD, Pudong New District
Shanghai, 201313
China
T Mr. Gianni del Vecchio:
+86 131 66090185
T Ms. Yuxuan Ye: +86 136 15814387
E peopleandobjects@outlook.com

Singapore

c/o Linea Light Singapore PTE. LTD.
21 Kaki Bukit Place, 5th Fl.
416199 Singapore
Singapore
T +65 6908 5758
E info.sg@linealight.com

Spain

c/o Linea Light Spain S.L.
C/ Longares, 48
28022 Madrid
Spain
T +34 912534773
E gestion@linedlight.com

United States

c/o Inter-lux, Inc.
3741 Commerce Dr Suite 306-308,
Halethorpe, MD 21227
USA
T +1 410 381 1497
E answers@inter-lux.com

Greece & Cyprus

c/o Aronoele Consulting Ltd
61 Lordou Vironos St. Lumiel Build
6023 Larnaca
Cyprus
T +30 2109940559
E g.virinis@linedlight.com

Thanks to:

Albedo
Arearea
Arper
Bolzan Letti
Brionvega
Cierre1972
Desalto
Dudubags
Fantin
Frag
Inkiostro Bianco
Itlas
Kasthall
Kristalia
La Fabbrica del Lino
LaCividina
Medulum
Miniforms
Minotti
Moroso
Niù
Novamobili
Passoni
Sportler
Tacchini
Thonet
Trabo
Wall&decò
Write sketch &

STILNOVO

a Linea Light Group brand

ADMINISTRATIVE HQ

Via Europa, 14

31028 Vazzola - TV

Italy

OPERATIVE HQ

Via della Fornace, 59

31023 Castelminio di Resana - TV

Italy

+39 0423 7868

info@stilnovo.com

Follow us on:

Instagram / Facebook / LinkedIn

September 2023 edition

© 2023 Linea Light Group

All rights reserved

