

joli



joli
designed to last

ABOUT US. 07

CHOICE FOR QUALITY. 13

GET INSPIRED. 23

Wire	24
Curve	44
Marguerite	52
Fizz	62
Chagall	70
Layers	76
Rafael	82
Propeller	88
Accessories	94
Cube	100

TECHNICAL SPECS. 107

Tables	108
Chairs & loungers	118
Accessories	130
Cabinets	136
Maintenance	150
Table tops	154
Fabrics	156



**ABOUT
US.**

Since its foundation in 1996, quality has been at the core for Joli. This is reflected in the stainless steel and aluminium tables with ceramic tabletops. But also in the other high-quality furniture, such as chairs, loungers, cabinets and, more recently, accessories. Thanks to their durability, the furniture is more than just an object. It becomes the place where you create lifelong memories.

Joli manufactures furniture that meet current material and stability standards, all aligning with the newest design trends.

Furthermore, we also offer bespoke furniture on request. Thanks to a wide range of finishes in a variety of styles, a great eye for detail and an ear to the latest developments in market trends, Joli manages to offer designs that are both timeless modern and trendy.

www.joli.be | [@joli_belgium](https://www.instagram.com/joli_belgium)



BELGIAN CUSTOMISED DESIGN

Joli is a Belgian quality brand for customized tables, chairs, accessories, loungers and cabinets. One by one handmade.

This also ensures that Joli can offer **custom-made craftsmanship**. With this offer, we occupy a unique position worldwide. Curious what we can do for you? Feel free to send us an email: info@joli.be.

Our products are 100% Belgian in terms of quality and design. We work exclusively with domestic designers. We are always looking for improvements to expand our brand.

Get ready to be inspired!





CHOICE FOR QUALITY.

Designed to last	15
John Ghekiere	17
Mathias De Ferm	19
Lieven Musschoot & Cas Moor	21

*"At Joli, we believe that
aesthetics & quality can
go hand in hand!"*

It all starts around the table & **we make sure it will last**

We believe in durability. Our furniture is designed to last. Robust, yet cosy. We always use stainless steel and aluminium for our tables and our table tops are made of Xeramica[®], a product that is beautiful and practical.

Because of our choice for quality all our tables, accessories and loungers can be used both indoors and outdoors. This also applies to many of our chairs and their cushions.

So, what are you in for? A new table for the terrace?
A new eye-catcher in the dining room? Or both?



Our indoor & outdoor products
are recognizable by this icon





MEET THE DESIGNER.

"We are still refining our know-how. As a trendsetter, we keep a close eye on our potential customers."

John Ghekiere

John Ghekiere, also known as Mister Joli, established Joli in 1996. As founder of the furniture brand, he is keen to see the company grow and develop. R&D is therefore his main focus. His keen interest in innovation, superior materials and a sharp eye for functional design are an intrinsic part of his personality. The creation of new products and directing marketing campaigns are his greatest passion.

THE JOLI-PORTFOLIO:

Tables

- » Curve
- » Easy-4
- » Propeller

Chairs

- » Cezanne
- » Chagall
- » Curve
- » Gaugin
- » Rafael





MEET THE DESIGNER.

“The challenge is to make a design that is beautiful, ergonomical and ecological at the same time.”

Mathias De Ferm

Mathias De Ferm is a product and furniture designer from Antwerp, Belgium. Collaborating with renowned international brands, his work includes furniture, products, lighting and micro-architecture. His work is characterized by a strong belief in the social relevance of design. A dining table, for instance, is not limited to its practical qualities. It forms the social centerpiece of a home: a place where people gather to eat, drink and talk with each other. This idea led to a serene yet warmhearted aesthetic and the frequent use of durable materials.

THE JOLI-PORTFOLIO:

Tables

- » Collins
- » Fizz
- » Marguerite
- » Wire

Chairs

- » Fizz
- » Marguerite
- » Wire

Loungers

- » Marguerite
- » Wire



MEET THE DESIGNERS.

Lieven Musschoot & Cas Moor

Lieven Musschoot graduated as an interior architect from the Architecture school Sint-Lucas in Ghent, Belgium. He believes interior architecture is a reaction between the client and the architect.

Cas Moor graduated in 2015 with a bachelor's degree in Interior Architecture and a masters degree in Autonomous design. His projects range from interior architecture, lighting, furniture and accessories to exhibitions and electronics.

Since 2014 Moor & Musschoot are a productdesign team. Their philosophy is: "It's obvious that a designer listens to the machines".

"You don't know where one man's inspiration ends and the other's creativity starts"

- Lieven Musschoot

"A good design to me is when an object is stripped down to its bare bones with the essence still intact."

- Cas Moor

THE JOLI-PORTFOLIO:

Accessories

- » Bite
- » Heatt
- » Turnable Disc





GET INSPIRED.

Wire	24
Curve	44
Marguerite	52
Fizz	62
Chagall	70
Layers	76
Rafael	82
Propeller	88
Accessories	94
Cube	100

WIRE

in + out



The idea behind the Wire collection, a design by Mathias De Ferm, is ingeniously simple. The tables and chairs are fashioned from fine, stainless steel wire: a single collection with one highly recognisable design line. These are suitable for both indoors and outdoors, are lightweight and solid, and are available in versatile finishes with a range of tabletops. A striking detail is that the legs are angled outwards from a central point, giving the entire piece an even lighter look.



Wire low chair in lino with nautic linen carbon [127]



DINE & WORK



AT THE SAME

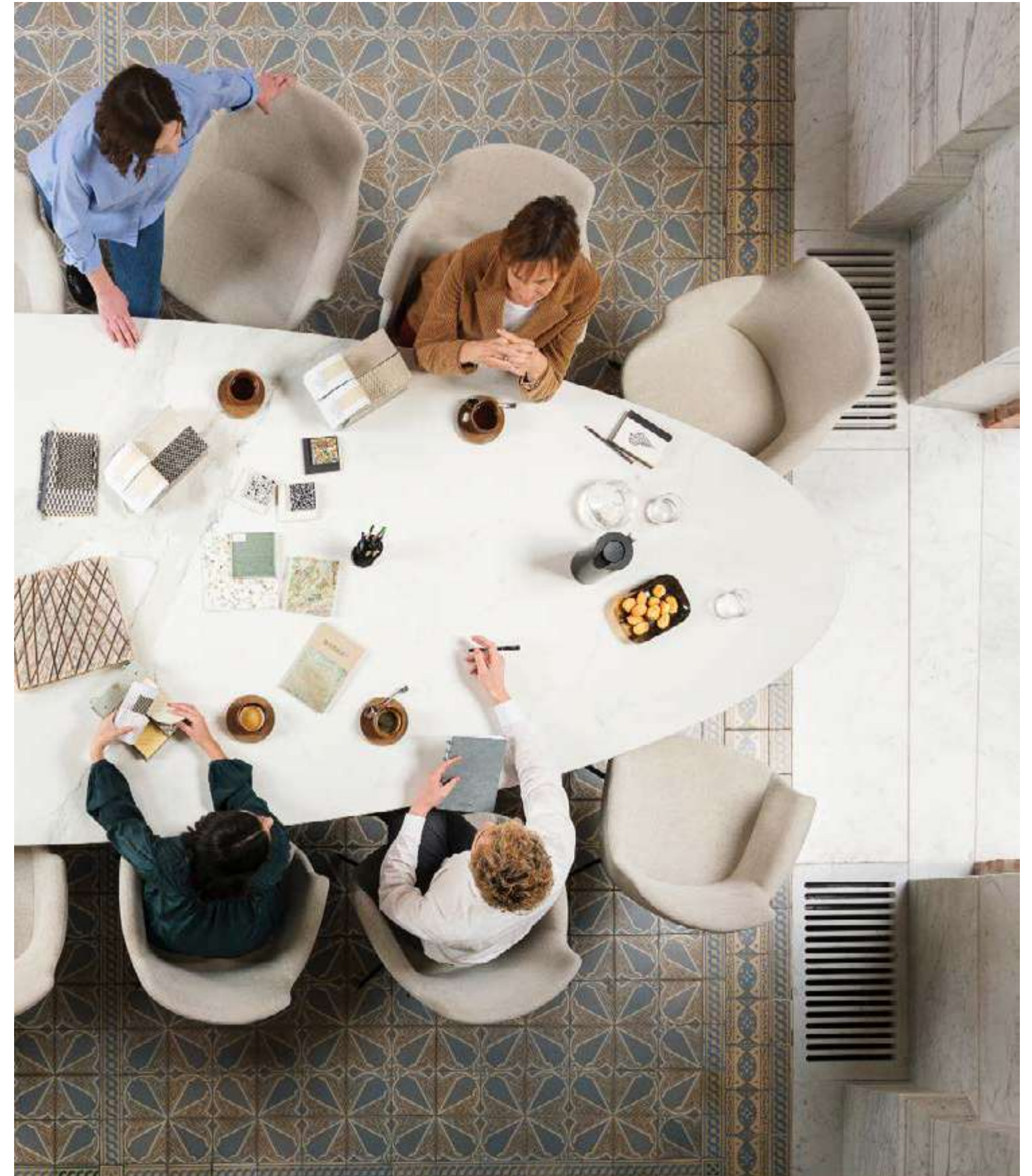

MAJESTIC TABLE

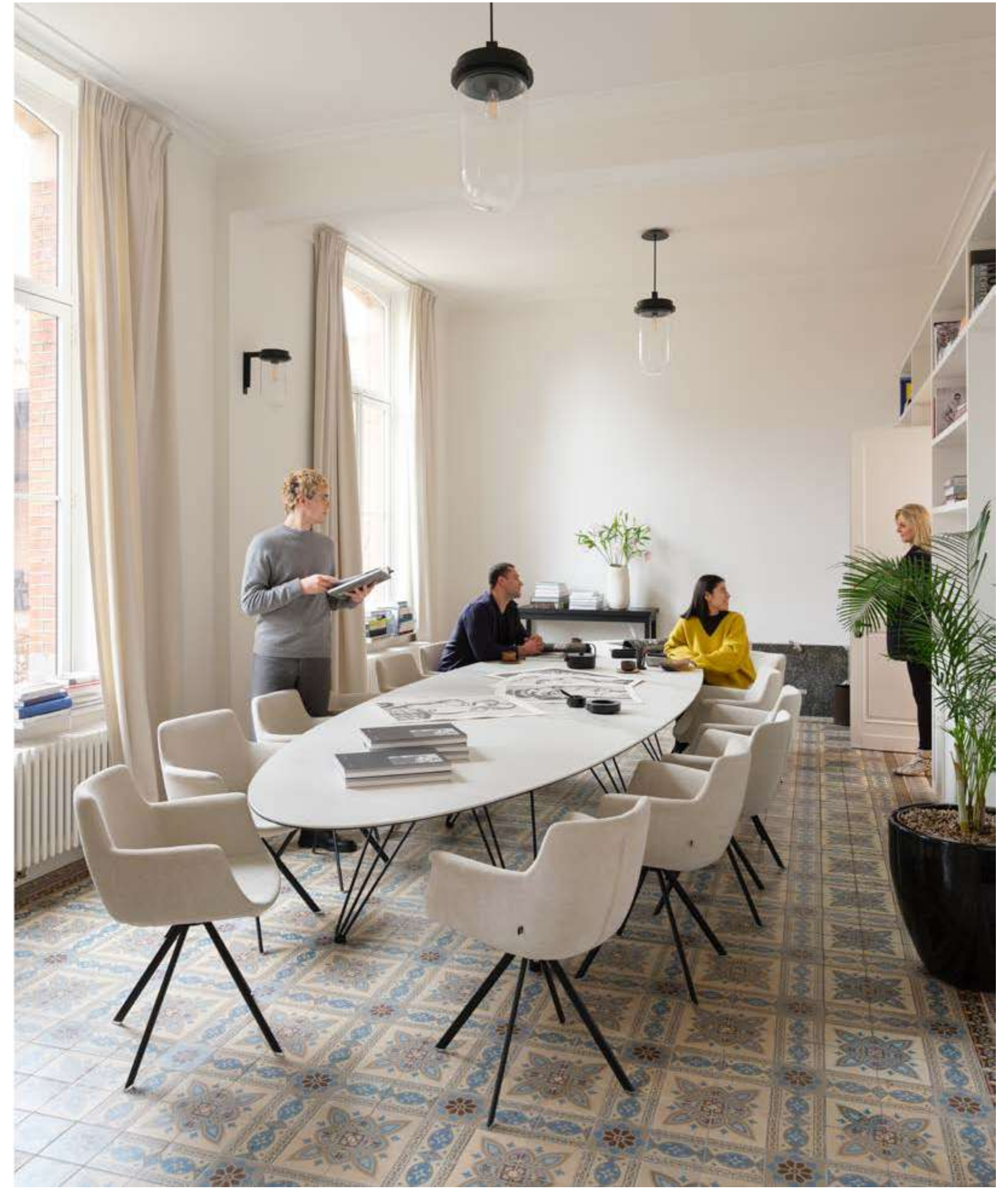

Wire Majestic black 5 metres with table top calacatta [117], Chagall spinning black in easy care fabric flax [120]



Wire elyps black with table top calacatta [117], Curve armchairs in vegan leather (skai) black [121] and Wire barstool black with smooth tagine cushion [127]



Left: **Wire** low chair black with cushion smooth tagine [127] and **Collins** side table black high and low black [110]
Right: **Wire** low chair black with cushion smooth ash [127] and **Collins** side table black high and low black [110]



Wire coffee table elyps with table top calacatta [117]
and Wire low chairs black with cushions nautic linen carbon [127]



Wire elyps black with table top black iron [117], **Wire** low chairs black with cushions nautic linen pepper [127] and **Wire** tabouret black with cushion nautic linen pepper [127]

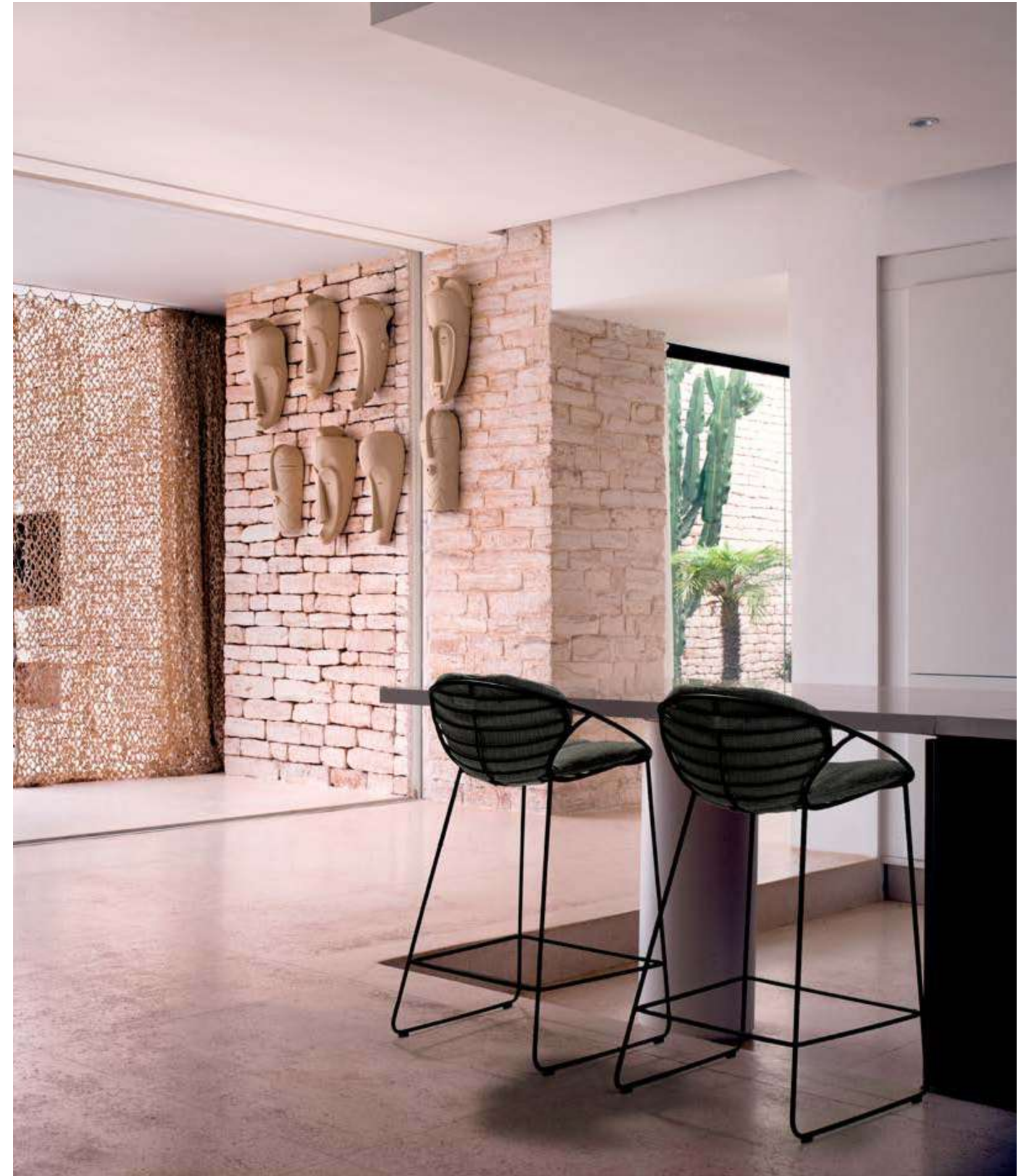

Wire barstools black with cushions nautic linnen pepper [127]



On the left: Wire lounge black [129]
On this page: Wire 2-seat with cushion nautic linen sand [128]



Wire Majestic 5 metres with table top marble marone [117]
and Wire armchairs black with cushions smooth canvas [127]

CURVE

in + out



Organic lines, that's what this collection is all about. These lines cause both the tables and the chairs to be a visual delight. However, they are also very practical. The chairs are perfect for long days of sitting, because the slight curve and the flexible upper part allow you to sit up straight without looking too stiff. The Curve chairs and tables can be put together in such a way that they complement any decor.



Curve elyps black with caravaggio table top [111] and Curve chairs black in vegan leather (skai) cognac [121]



Curve elyps black with table top caravaggio [111] and Curve chairs black in smooth tagine [121]



Curve XXL faux elyps black with table top marble marone [111]
and Curve armchairs black in smooth sooty [121]



Curve faux elyps with table top marble azuro [111]
and Fizz armchairs black with cushions nautic linen carbon [122]

MARGUERITE

in + out



A true masterpiece, Marguerite only reveals its secrets to the careful observer. The unassuming design of the table and the character of its conical legs make it an easy fit for any environment, whether indoors or outdoors. At the same time, its presence adds a subtle but priceless elegance to any occasion.

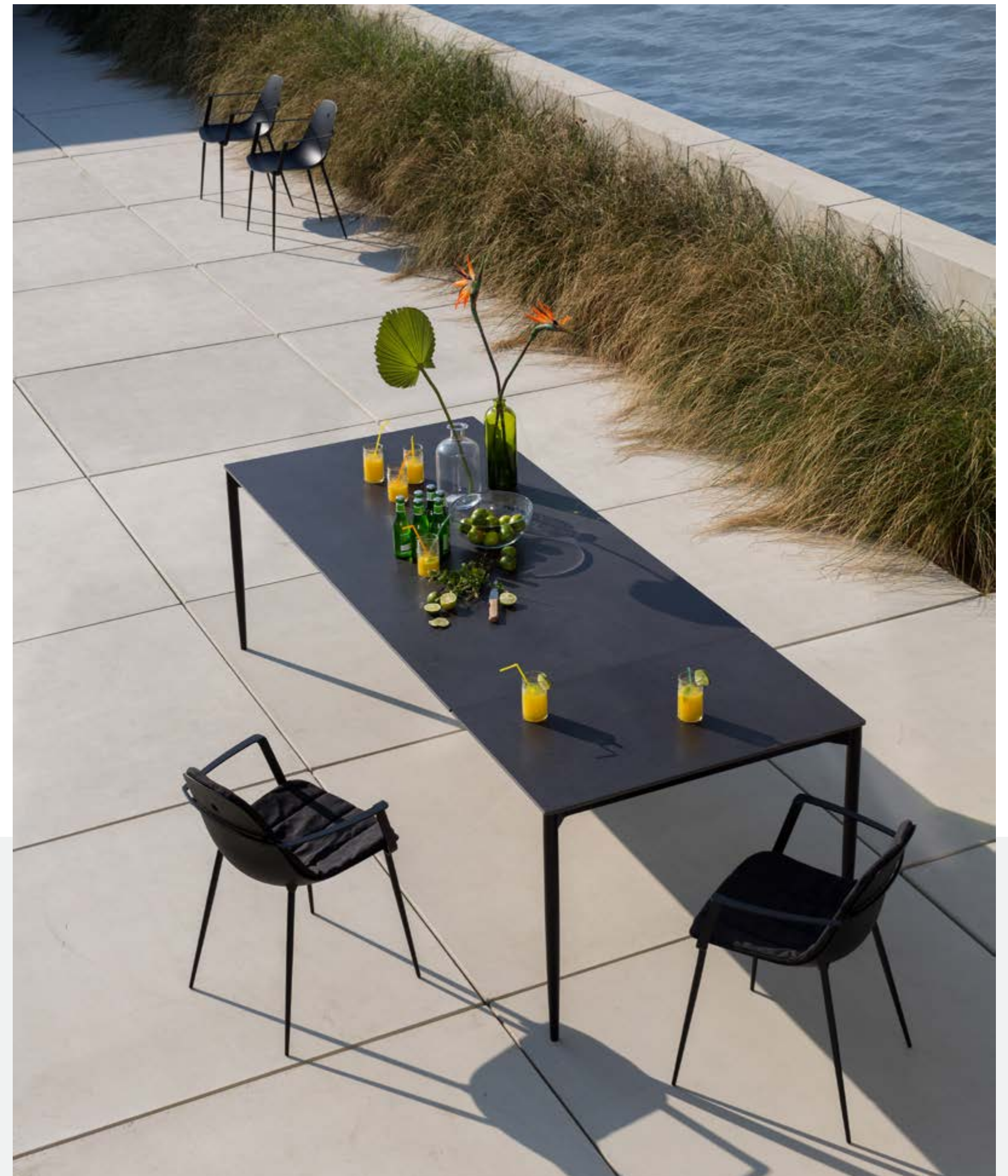

Marguerite XXL table black with table top black iron [115] and Marguerite black armchair with cushions nautic linen carbon [124]



Marguerite elyps black with table top soft oak [115]
and Marguerite chairs black with shell smooth sooty [124]



Marguerite elyps black with table top soft oak [115] and **Marguerite** chairs black with shell smooth sooty [124]

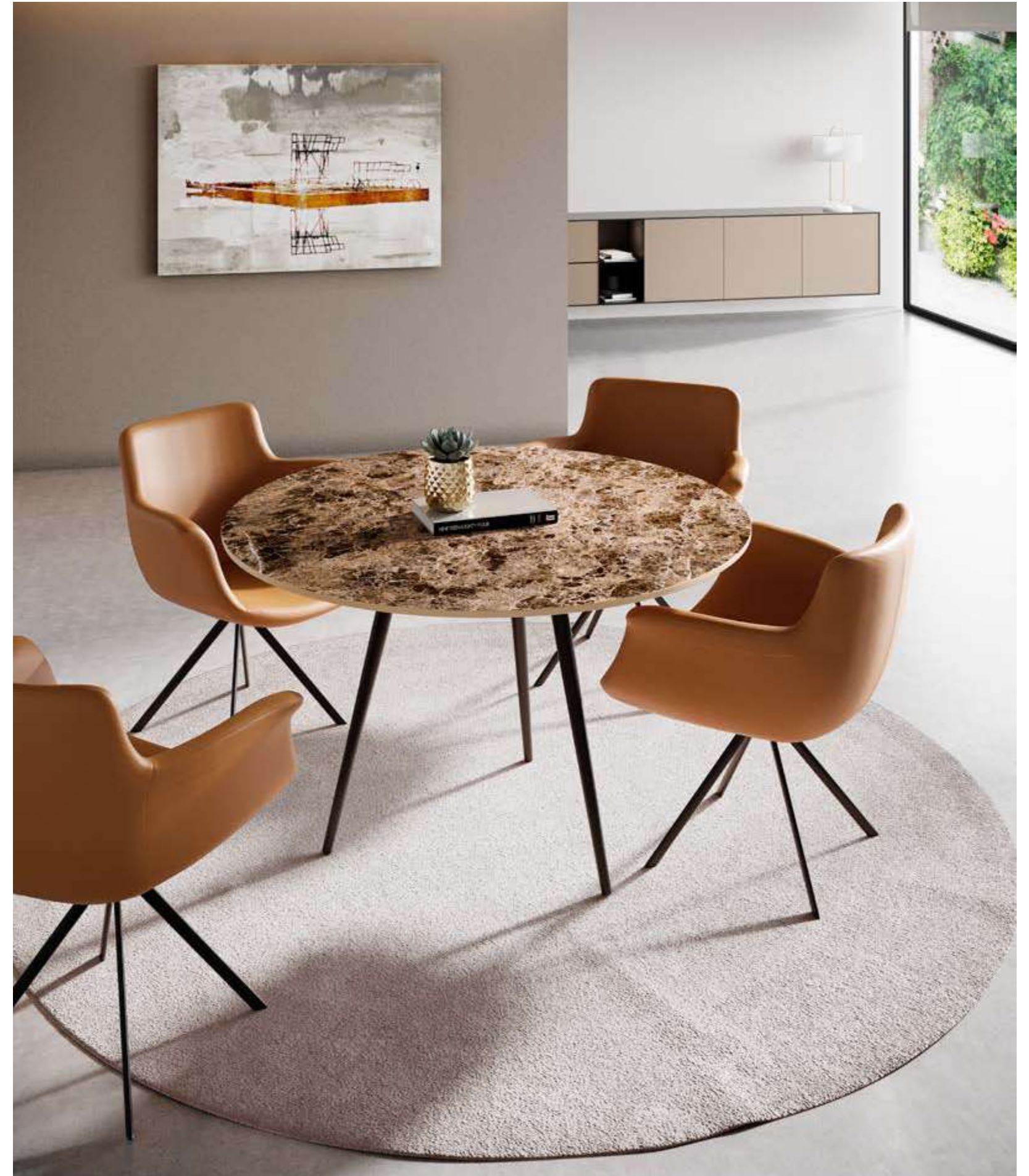

Marguerite round table black with table top emperador [115] and **Chagall** spinning black in vegan leather (skai) cognac [120]



Marguerite coffee table lino with table top calacatta [115],
Marguerite sofa lino with cushions nautic linen sahara & bamboo [125],
Fizz low chair lino with cushion nautic linen bamboo [122]
 and **Marguerite** loungers with cushions nautic linen sahara & bamboo [125]



On the left: Marguerite lounge black with cushion nautic linen carbon [125], Collins side table black [110]
On this page: Fizz bistro round black with table top marble azuro [113], Marguerite armchair black [124]

FIZZ

in + out



The starting point of this collection is organically shaped aluminium. The slender, feminine lines and curves give these tables and chairs a visual lightness. The seat pattern was inspired by traditional rattan. Replacing this with high-end Italian rope produces an extremely attractive and recognisably modern look. Not only is the rope very comfortable to sit on, it is also totally weatherproof and dries extremely quick.



Fizz big round with table top marble azuro [113] and Fizz armchair black [122]



Fizz bistro black dia 70, height 110 cm with table top marble marone [113]



Fizz big round black with table top black iron [113], **Marguerite** armchairs black with shell vegan leather (skai) black [124], **Cube 70 D / SLL / SD / D** in Matilux® black [143], **Wire** low chair black with cushion leather cognac [127] and **Collins** side table low black [110]



Fizz bistro round dia 70 black with table top marble azuro [113] and Fizz armchairs black with cushions nautic linen carbon [122]



Fizz bistro square with table top emperador [113] and Fizz armchairs black with cushions nautic linen carbon [122]

CHAGALL



The ultimate in femininity: Chagall's 'egg cup' curves are organic and graceful. The shaped foam seat can be upholstered in vegan leather or a fabric with a pleasant feel. This beautifully designed armchair is available with either a fixed (x-base / sled base) or spinning foot. Despite its strikingly light structure, this is a strong, long-lasting chair.



Chagall spinning black in velvet beige [120]



Fizz big round with table top marble azuro [113] and Chagall spinning black in corallo blue [120]

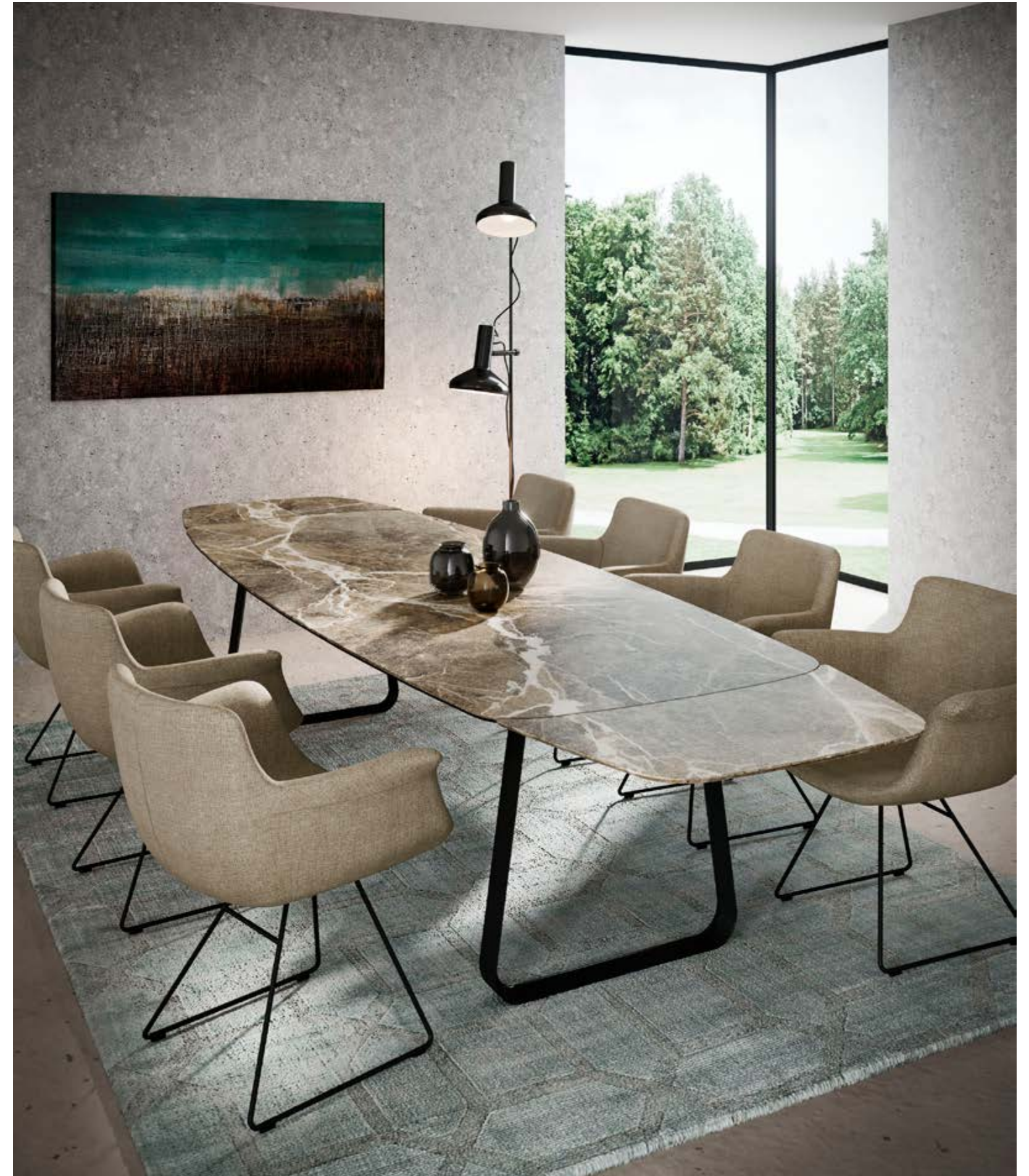

Curve XXL faux elyps black with table top marble marone [111] and Chagall sled base black in corallo beige [120]



Wire Majestic black 5 metres with table top calacatta [117]
and Chagall spinning black in easy care flax [120]

LAYERS

in + out



Layers, with a table top that appears to float, this table looks very light and spacious. It is also true to its aesthetic beauty thanks to its extremely thin frame. This in combination with one of the twelve ceramic tabletops makes Layers an excellent and elegant table for indoor and outdoor use.



Layers dining table black with table top soft oak [114]



Layers dining table black with table top soft oak [114], Rafael sled base black in easy care flax [126] and Collins side table black [110]



Layers dining table black with table top soft oak [114] and Fizz armchairs black [122]

RAFAEL



Modern, stately and surprisingly comfortable: the Rafael chair is a must for anyone looking for the ultimate combination of sober refinement and warm conviviality. The minimalist design gives your living room a sophisticated aura. The seating gyrates on the base for optimal comfort.



Rafael sled base black in vegan leather (skai) black [126]



Layers dining table black with table top soft oak [114] and **Rafael** sled base black in easy care flax [126]



Rafael bar stools low black in vegan leather (skai) black [126]



Layers dining table black with table top soft oak [114]
and **Rafael** x-base black in vegan leather (skai) black [126]

PROPELLER

in + out



The sleek, streamlined Propeller dining table exudes peace and strength. The base, crafted in stainless steel and inspired by aircraft propellers, ensures stability.



Propeller rectangular white with absolute white table top [116]



Propeller rectangular white with absolute white table top [116],
 Wire armchairs white with cushions smooth canvas [127],
 Heatt 95 in absolute white [133], Heatt dia 21 in absolute white [134] and Bite dia 35 in oak [132]



Propeller rectangular white with table top soft oak [116], Chagall sled base white in easy care truffle [120] and Cube 55 2L/space/3L in Matilux® bronze [141]

ACCESSORIES

in + out



Everything starts at the table. And who doesn't love evenings that slowly turn into the night while you're still picking from the food on the table. Especially for these occasions we now have 3 types of table accessories: Heatt to keep your food warm, Bite which you can easily attach to your table to create more space and thanks to the Turnable Disc, everything is within reach.



Heatt 95 in absolute white [133] and Heatt dia 21 in absolute white [134]



On the left: Heatt dia 21 in soft oak [134]
On this page: Heatt 145 in soft oak [133] and Heatt dia 21 in soft oak [134]



Heatt 140 in soft oak [133]

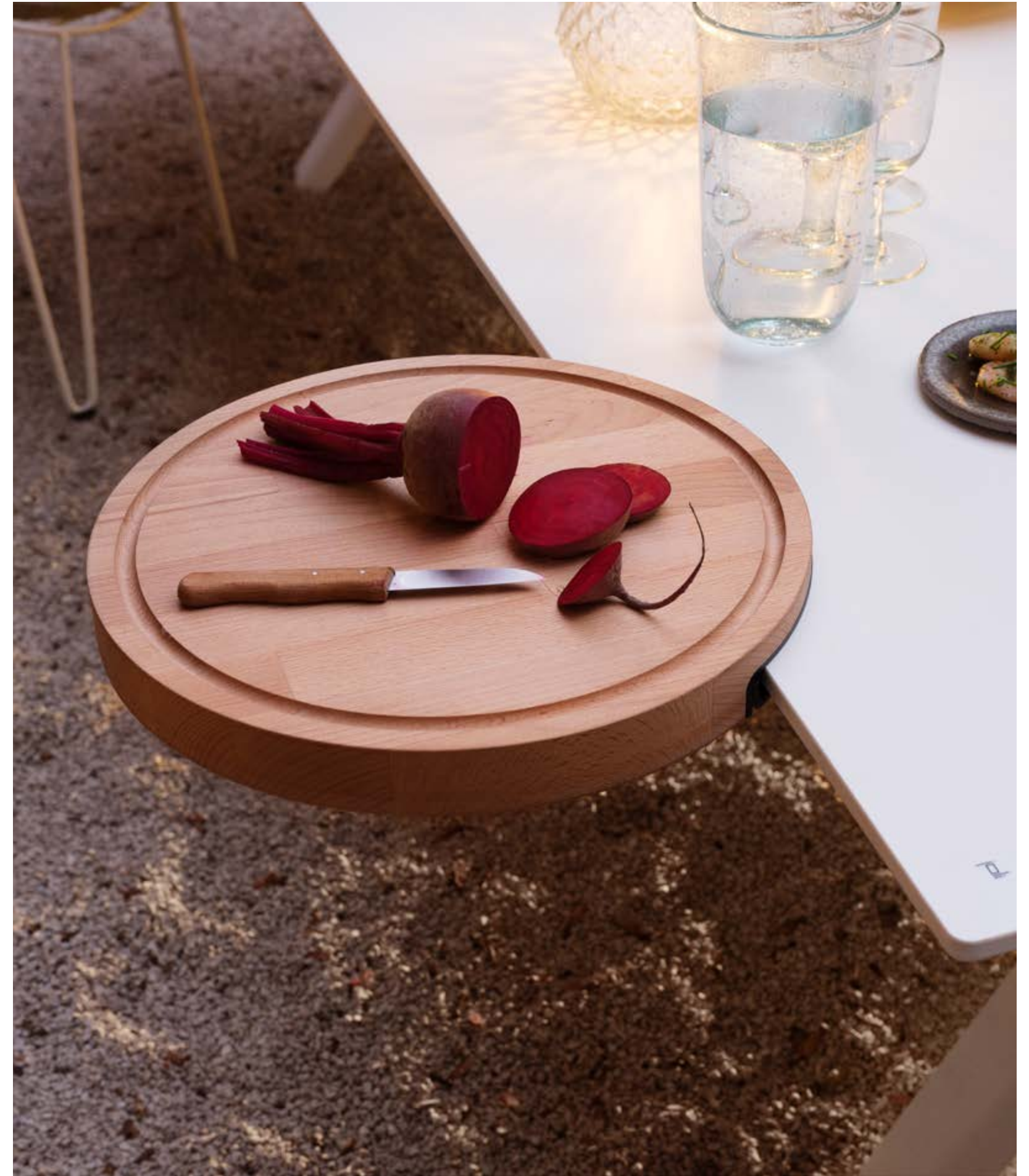

Bite dia 35 in oak [132]

CUBE

Meet Cube, our cabinet collection. The options are endless. The separate blocks can be put together in such a way that they deserve a place in every interior.

There are endless color combinations to be made. Give everything the same colour or choose a variation between the inside, outside and top. Thanks to the material the doors are made of, Matilux®, you no longer have any problems with stripes, scratches and reflections in the sun.

You can choose between Cube 55, 70, 85 and 193. Did you know that the number in the name refers to the height of the separate blocks?

Via the step-by-step guide on the next page, we will help you put together the perfect cabinet!

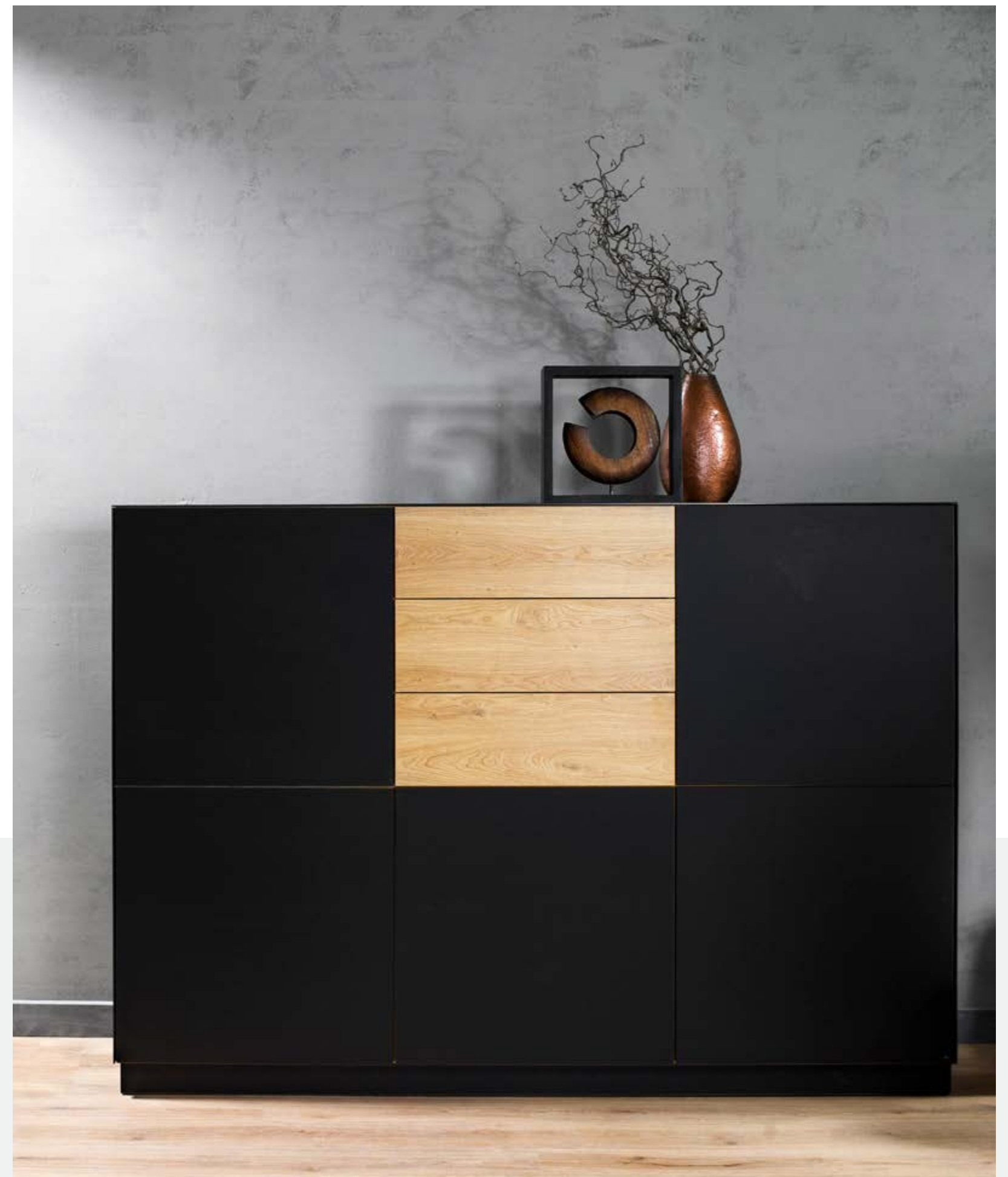

Cube 70 double 6 doors in Matilux® black with drawer box without glass [143]



Fizz big round black with table top black iron [113], Marguerite armchairs black with shell vegan leather (skai) black [124], Cube 70 in D / SLL / SD / D Matilux® black [143] and Wire low chair black with cushion velvet blue [127]



Cube 193 Cosy 4 inside melamine nature oak, front Matilux® black [149],
Wire low chair black with cushion leather cognac [127] and **Collins** side table black [110]



TECHNICAL SPECS.

Tables	108
Chairs & loungers	118
Accessories	130
Cabinets	136
Maintenance	150
Table tops	<i>fold-out page</i>
Fabrics	<i>fold-out page</i>

TABLES.

TABLE TOPS.

For all tables, except the Collins side table, it is possible to choose one of the following Xeramica® table tops.



Calacatta
6 + 6 mm



Emperador
13 mm



Black Iron
13 mm



Absolute White
13 mm



Beton
13 mm

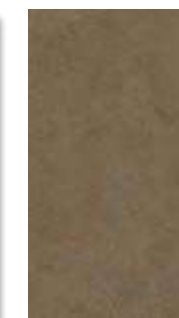

Lava Brown
13 mm



Marble Azuro
13 mm



Marble Marone
13 mm



Caravaggio
13 mm



Travertino Grey
13 mm



Soft Oak
13 mm



Charisma Grey
13 mm

For a full overview see
page 155 or go to:
joli.be/ceramic



TABLES

Collins side table.

Designed by Mathias De Ferm

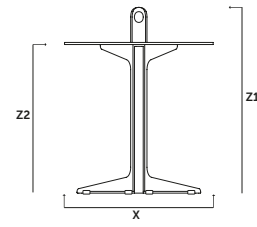

DIMENSIONS	X	Z1	Z2
low lacquered aluminium	dia 44	56	46
high lacquered aluminium	dia 44	66	56

FRAME



Curve.

Designed by John Ghekiere

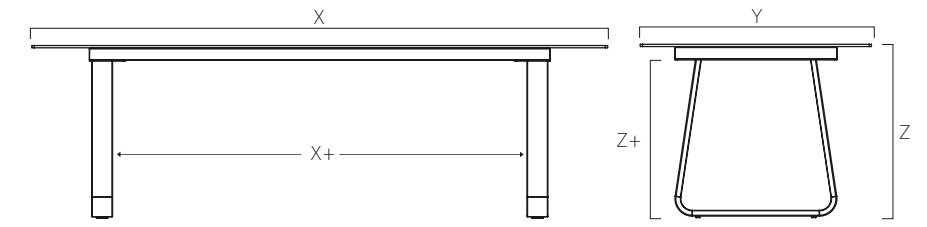
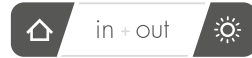

DIMENSIONS		X	Y	Z	X+	Z+
rectangular	lacquered aluminium	300	100	75	230	68.5
		250	100	75	180	68.5
		220	100	75	150	68.5
		200	100	75	138	68.5
		180	90	75	110	68.5
rectangular extendable XL/XXL	lacquered aluminium	215 - 315	100	75	180	65.8
		160 - 240	100	75	121	65.8
faux elyps	lacquered aluminium	300	110	75	230	68.5
		250	110	75	180	68.5
		220	110	75	150	68.5
		200	110	75	138	68.5
		180	100	75	110	68.5
faux elyps extendable XL/XXL	lacquered aluminium	220 - 320	110	75	180	65.8
		165 - 245	110	75	136	65.8
elyps	lacquered aluminium	300	128	75	140	68.5
		250	128	75	140	68.5
		210	128	75	140	68.5

FRAME

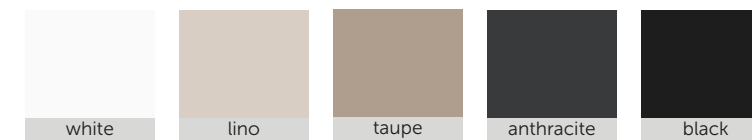

TABLE TOPS

Xeramica® > [page 154]

- | | | |
|----------|-------------------|---------------------------|
| 6 + 6 mm | • Calacatta | not for extendable models |
| 13 mm | • Beton | • Marble Azuro |
| | • Black Iron | • Caravagio |
| | • Travertino Grey | • Absolute White |
| | • Emperador | • Soft Oak |
| | • Lava Brown | • Charisma Grey |
| | • Marble Marone | |



Easy-4.

Designed by John Ghekiere

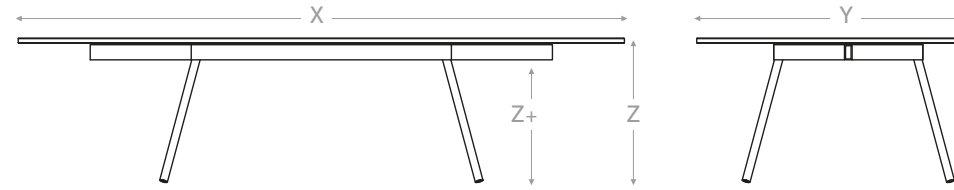

DIMENSIONS		X	Y	diameter	Z	Z+
rectangular	<i>lacquered steel</i>	150	100	-	29	25
		130	70	-	29	25
		100	100	-	29	25
round	<i>lacquered steel</i>	-	-	120	29	25
		-	-	100	29	25

FRAME



TABLE TOPS

Xeramica® > [page 154]

- 6 + 6 mm • Calacatta
- 13 mm • Beton • Marble Azuro
- Black Iron • Caravagio
- Travertino Grey • Absolute White
- Emperador • Soft Oak
- Lava Brown • Charisma Grey
- Marble Marone



Fizz.

Designed by Mathias De Ferm

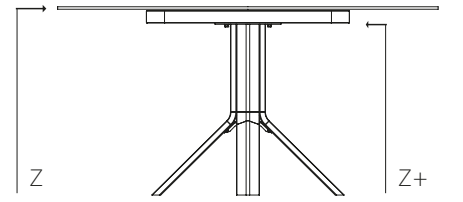

DIMENSIONS		diameter	Z	Z+	
big dining round	<i>lacquered aluminium</i>	150	75	68.5	
		120	75	68.5	
big dining square	<i>lacquered aluminium</i>	X	Y	Z	Z+
		150	150	75	68.5
		130	130	75	68.5

bistro round		diameter	Z	4-legs table without click system	
<i>tripod table with click system</i>		70	66	80	66
		70	75	80	75
		70	90	80	90
		70	110	80	110
bistro square		square	Z	4-legs table without click system	
<i>tripod table with click system</i>		70	66	80	66
		70	75	80	75
		70	90	80	90
		70	110	80	110

FRAME



TABLE TOPS

Xeramica® > [page 154]

- 6 + 6 mm • Calacatta
- 13 mm • Beton * • Marble Azuro
- Black Iron • Caravagio
- Travertino Grey • Absolute White
- Emperador • Soft Oak
- Lava Brown • Charisma Grey
- Marble Marone

* Beton is not possible for big dining round dia 150 and big dining square.

OPTIONS

- Adjustment dia, length and/or width: 25% closest standard dimension. Maximum dia is 150.



Layers.

Designed by Sylvain Willenz

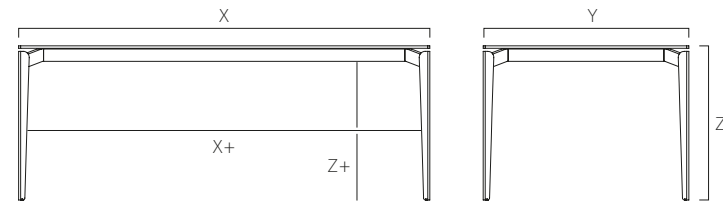

DIMENSIONS		X	Y	Z	X+	Z+
dining table	<i>lacquered steel</i>	300	100	75	289	67.5
		250	100	75	239	67.5
		220	100	75	209	67.5
		200	100	75	189	67.5
		180	90	75	169	67.5
wall table	<i>lacquered metal</i>	200	40	75	-	67.5
		160	40	75	-	67.5
coffee table	<i>lacquered metal</i>	150	100	29	-	-
		130	70	29	-	-
		100	100	29	-	-
lamp table	<i>lacquered metal</i>	55	55	43	-	-

FRAME



TABLE TOPS

Xeramica® > [page 154]

- 6 + 6 mm • Calacatta
- 13 mm • Beton • Marble Azuro
- Black Iron • Caravagio
- Travertino Grey • Absolute White
- Emperador • Soft Oak
- Lava Brown • Charisma Grey
- Marble Marone

OPTIONS

- Adjustment length and/or width: 25% closest standard dimension
- Oval cable entry



Marguerite.

Designed by Mathias De Ferm

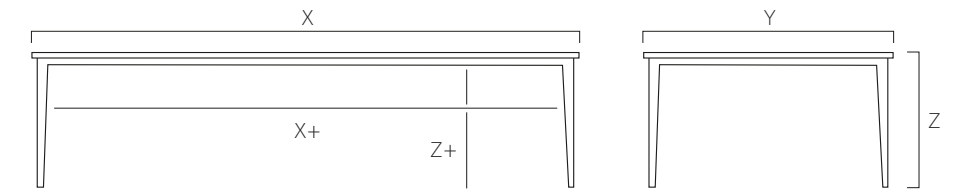

DIMENSIONS		X	Y	Z	X+	Z+
rectangular	<i>lacquered aluminium</i>	300	100	75	290	67.5
		250	100	75	240	67.5
		220	100	75	150	67.5
		200	100	75	138	67.5
		180	90	75	110	67.5
		180	90	75	110	67.5
rectangular extendable XL/XXL	<i>lacquered aluminium</i>	200 - 260	100	75	190	67.5
		160 - 220	100	75	150	67.5
dining table square	<i>lacquered aluminium</i>	150	150	75	140	67.5
		130	150	75	120	67.5
		100	100	75	90	67.5
dining table round	<i>lacquered aluminium</i>	dia 150	-	75	-	73.5
		dia 120	-	75	-	73.5
		dia 100	-	75	-	73.5
dining table elyps	<i>lacquered aluminium</i>	300	128	74.5	165,7	73.3
		250	128	74.5	127,7	73.3
		210	128	74.5	127,7	73.3
bistro	<i>lacquered aluminium</i>	70	70	75	60	67.5
coffee table	<i>lacquered aluminium</i>	130	70	32	120	29
		100	100	32	90	29
lamp table	<i>lacquered aluminium</i>	55	55	46.5	45	43

FRAME

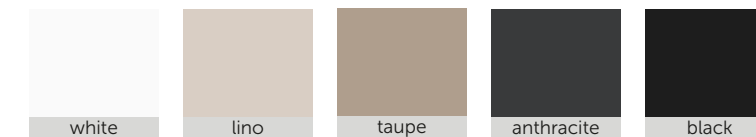

TABLE TOPS

Xeramica® > [page 154]

- 6 + 6 mm • Calacatta
- 13 mm • Black Iron • Marble Azuro
- Travertino Grey • Caravagio
- Emperador • Absolute White
- Lava Brown • Soft Oak
- Marble Marone • Charisma Grey

* Beton is not possible for dining table round dia 150 and dining square 150.

OPTIONS





- Adjustment dia, length and/or width: 25% closest standard dimension. Maximum dia is 150.

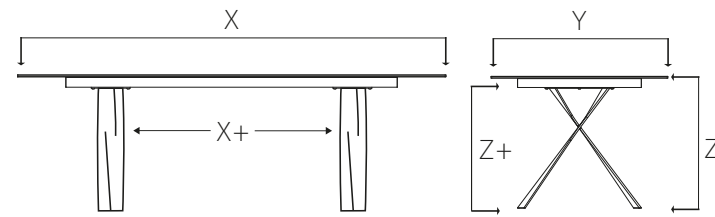

Propeller.

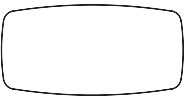
Designed by John Ghekiere

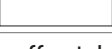

DIMENSIONS	X	Y	Z	X+	Z+
dining table rectangular <i>lacquered steel</i>	300	100	75	194	68.5
	250	100	75	144	68.5
	220	100	75	114	68.5
	200	100	75	94	68.5
	180	90	75	74	68.5
dining table faux elyps <i>lacquered steel</i>	300	110	75	194	68.5
	250	110	75	144	68.5
	220	110	75	114	68.5
	200	110	75	94	68.5
	180	100	75	74	68.5
dining table elyps <i>lacquered steel</i>	300	128	75	134	67.5
	250	128	75	84	67.5
	210	128	75	84	67.5
wall table rectangular <i>lacquered aluminium</i>	200	40	75	135	68.5
	160	40	75	95	68.5
coffee table rectangular <i>lacquered aluminium</i>	150	100	38	-	31.5
	130	70	38	-	31.5
	100	100	38	-	31.5

FRAME



TABLE TOPS

Xeramica® > [page 154]

- 6 + 6 mm • Calacatta
- 13 mm • Beton • Marble Azuro
- Black Iron • Caravagio
- Travertino Grey • Absolute White
- Emperador • Soft Oak
- Lava Brown • Charisma Grey
- Marble Marone





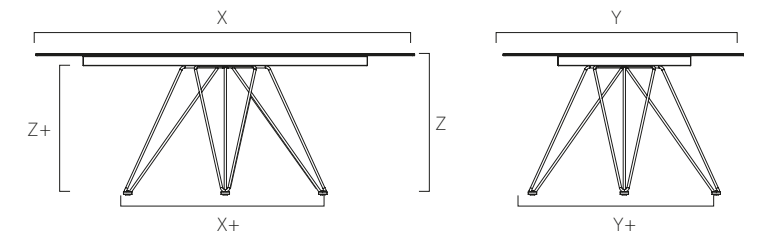

OPTIONS

- Adjustment length and/or width: 25% closest standard dimension
- Oval cable entry

Wire.

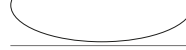
Designed by Mathias De Ferm



DIMENSIONS	X	Y	Y max.	Z	X+	Y+	Z+
dining table rectangular <i>lacquered steel</i>	300	100	128	75/66	197	74/102	69/60
	250	100	128	75/66	147	74/102	69/60
	220	100	128	75/66	108	74/102	69/60
	200	100	128	75/66	108	74/102	69/60
	180	90	128	75/66	108	74/102	69/60
dining table square <i>lacquered steel</i>	150	150	-	75/66	99	99	69/60
	130	130	-	75/66	77	77	69/60
	128	138	-	75/66	77	77	69/60
majestic table elyps <i>lacquered steel</i>	600*	150	-	75	411	101	69
	500*	150	-	75	311	101	69
	400*	150	-	75	212	101	69
dining table elyps <i>lacquered steel</i>	300	128	-	75/66	147	74	69/60
	250	128	-	75/66	147	74	69/60
	210	128	-	75/66	147	74	69/60
dining table faux elyps <i>lacquered steel</i>	300	110	128	75/66	197	74/102	69/60
	250	110	128	75/66	147	74/102	69/60
	220	100	128	75/66	108	74/102	69/60
	200	110	128	75/66	108	74/102	69/60
	180	100	128	75/66	108	74/102	69/60
dining table round <i>lacquered steel</i>	dia 150	-	-	75/66	dia 77	dia 77	69/60
	dia 120	-	-	75/66	dia 77	dia 77	69/60
coffee table rectangular <i>lacquered steel</i>	100	100	-	29	86	86	23
	150	100	-	29	135	85	23
	130	70	-	29	108	48	23
coffee table elyps <i>lacquered steel</i>	160	70	-	29	118	48	23
	120	60	-	29	89	48	23

FRAME

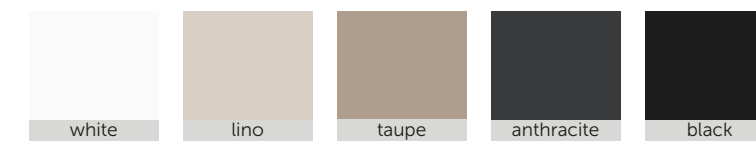

TABLE TOPS

Xeramica® > [page 154]

- 6 + 6 mm • Calacatta
- 13 mm • Beton • Marble Azuro
- Black Iron • Caravagio
- Travertino Grey • Absolute White
- Emperador • Soft Oak
- Lava Brown • Charisma Grey
- Marble Marone

* Beton is not possible for dining table round dia 150 and dining table square 150.

CHAIRS & LOUNGERS

FABRICS.

Easy Care Fabrics.



Velvet.



Corallo.



Vegan leather (skai).

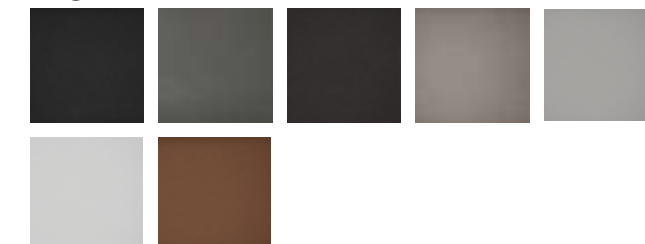

Leather.

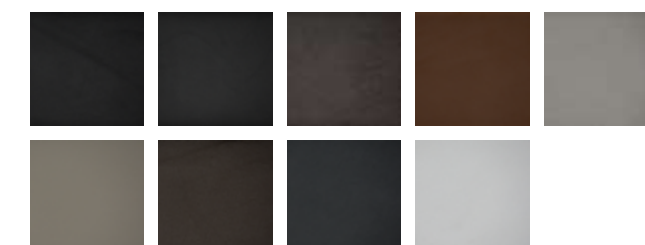

Nautic linen. in-out

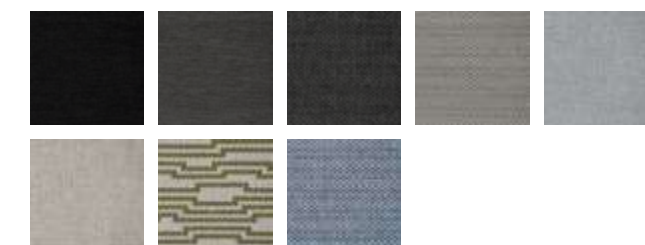

Smooth. in-out



For a full overview
see page 156 or go to
joli.be/fabrics



Chagall.

Designed by John Ghekiere



x-base spinning sled base

DIMENSIONS



chair x-base	lacquered metal	62	57	80	47	67
chair spinning	lacquered metal	62	57	80	47	67
chair sled base	lacquered metal	61	57	78	47	65

FRAME metal frame, nosag springs



SEATING

- Velvet
- Corallo
- Smooth
- Easy Care Fabrics
- Vegan leather (skai)

All colors > [page 156]



Curve.

Designed by John Ghekiere

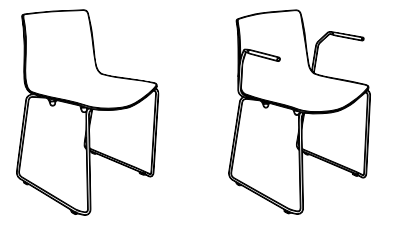
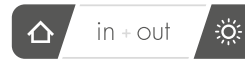

chair armchair

DIMENSIONS



chair	lacquered metal		49	49	80	48	-
armchair	lacquered metal		49	49	80	48	68
chair	stainless steel		49	49	80	48	-
armchair	stainless steel		49	49	80	48	68

FRAME

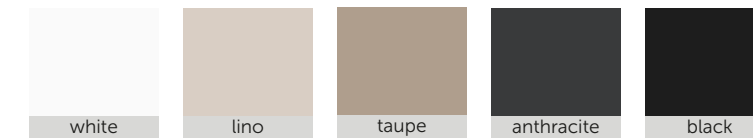

SEATING

- Vegan leather (skai)
- Easy Care Fabrics
- Velvet
- Corallo
- Nautic linen
- Smooth

All colors > [page 156]



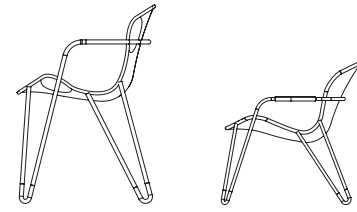

armchair low chair

DIMENSIONS



armchair	lacquered aluminium	50	61	79	46	65
low chair	lacquered aluminium	59	76	69	39	54

FRAME

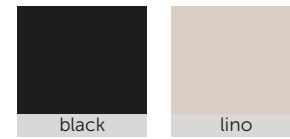

ROPE SOLEMIO

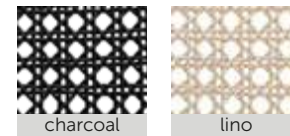

CUSHION

- Smooth
 - Nautic linen
- All colors > [page 156]

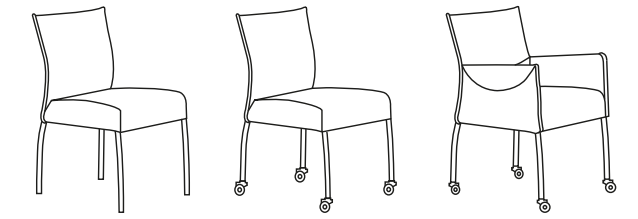

chair chair + vespa wheels armchair + vespa wheels

DIMENSIONS



chair	metal frame, nosag springs	49	59	86	49	-
chair + vespa wheels	metal frame, nosag springs	49	59	86	49	-
armchair	metal frame, nosag springs	57	52	85	48	64
armchair + vespa wheels	metal frame, nosag springs	57	52	85	48	64

FRAME & COVER *metal frame, nosag springs*

- Leather
- Velvet
- Corallo
- Smooth
- Easy Care Fabrics

All colors > [page 156]

VESPA WHEELS

- Aluminium
- White
- Black



Marguerite.

Designed by Mathias De Ferm

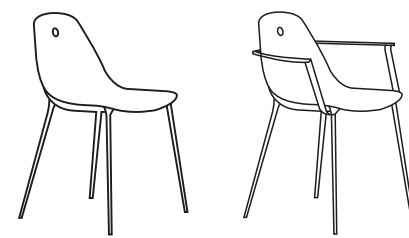

chair armchair

DIMENSIONS



chair	lacquered aluminium	45	54	79	49	-
armchair	lacquered aluminium	57	54	79	49	66
shell	covered plastic (ABS)	44	49	-	-	-
cushion		45	44	-	-	-

FRAME

lacquered aluminium



SEATING

- Leather
- Easy Care Fabrics
- Velvet
- Corallo
- Nautic linen
- Smooth

in

in + out

All colors > [page 156]



Marguerite lounge.

Designed by Mathias De Ferm

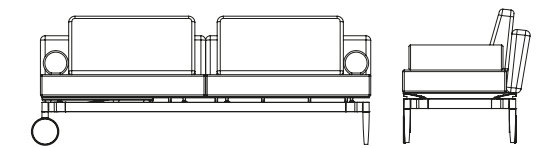

DIMENSIONS



lounge	lacquered aluminium	210	70	30
lounge cushion (with headrest)		210	70	4
sofa (including all sofa cushions)		210	80	85

FRAME

lacquered aluminium

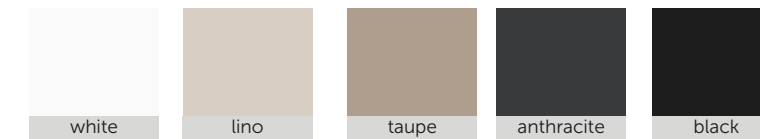

SEATING

Batylene

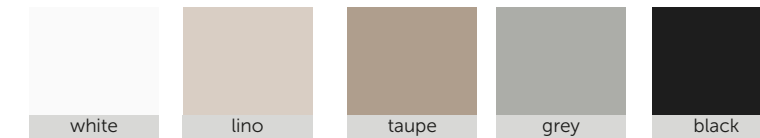

CUSHIONS

- Nautic linen
- Smooth

All colors > [page 156]

TRANSFORM YOUR LOUNGER INTO A SOFA



Rafael.

Designed by John Ghekiere

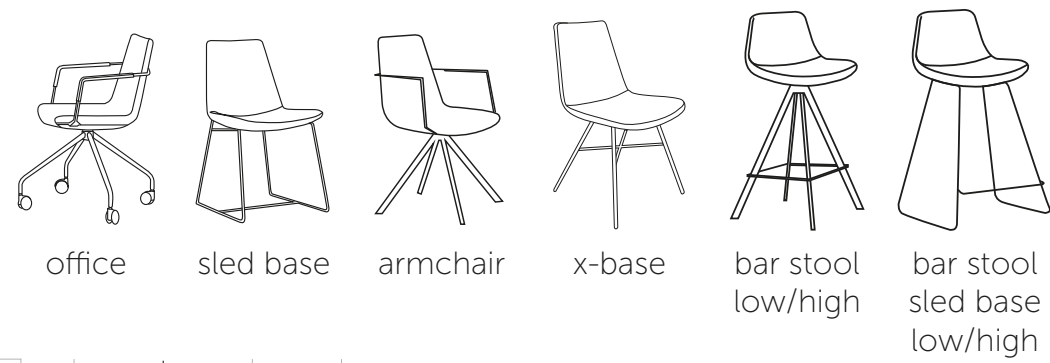

DIMENSIONS



office	<i>lacquered metal, with 4 wheels</i>	52	55	82	49	69
sled base	<i>lacquered metal</i>	47	59	82	48	-
armchair	<i>lacquered metal</i>	55	55	81	48	67
x-base	<i>lacquered metal</i>	47	55	81	47	-
barstool low	<i>lacquered metal</i>	43	47	85	66	-
barstool high	<i>lacquered metal</i>	44	42	96	74	-
barstool low sled base	<i>lacquered metal</i>	43	47	85	61	-
barstool high sled base	<i>lacquered metal</i>	43	48	95	71	-

FRAME

lacquered aluminium



SEATING

- Velvet
- Corallo
- Smooth
- Easy Care Fabrics
- Vegan leather (skai)

All colors > [page 156]



Wire.

Designed by Mathias De Ferm



DIMENSIONS

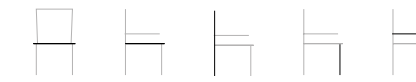

armchair	<i>lacquered stainless steel</i>	61	55	78	46	63
cushion armchair		53	47	-	-	-
low chair	<i>lacquered stainless steel</i>	76	74	74	45	53
cushion low chair		63	55	-	-	-
bar stool	<i>lacquered stainless steel</i>	51	53	86	67	74
cushion bar stool		44	42	-	-	-
tabouret	<i>lacquered stainless steel</i>	66	49	-	40	-
cushion tabouret		-	-	-	-	-

FRAME

lacquered aluminium



SEATING

- Leather
- Easy Care Fabrics
- Velvet
- Corallo
- Nautic linen
- Smooth

All colors > [page 156]



Wire 2-seat & 3-seat.

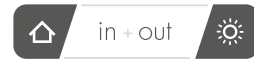

Designed by Mathias De Ferm

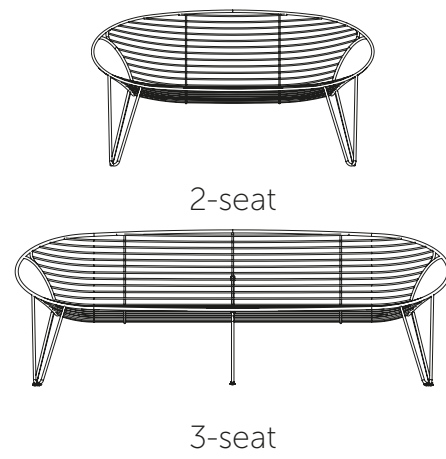

DIMENSIONS



2-seat	lacquered stainless steel	135	67.5	74.5	37
3-seat	lacquered stainless steel	210	68.5	74.5	36.5

FRAME

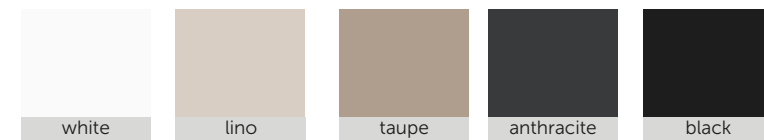

SEATING

- Leather
- Easy Care Fabrics
- Velvet
- Corallo
- Nautic linen
- Smooth

All colors > [page 156]

Wire lounge.



Designed by Mathias De Ferm

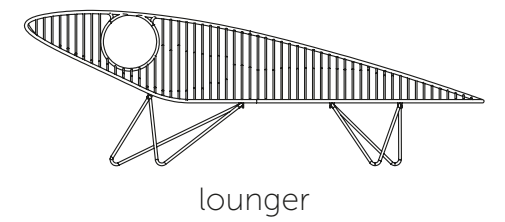

DIMENSIONS



lounge	lacquered stainless steel	201	72.7	68.5	38.5
--------	---------------------------	-----	------	------	------

FRAME

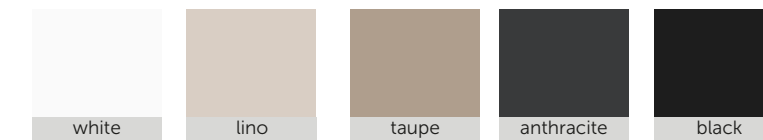

SEATING

- Leather
- Easy Care Fabrics
- Velvet
- Corallo
- Nautic linen
- Smooth

All colors > [page 156]

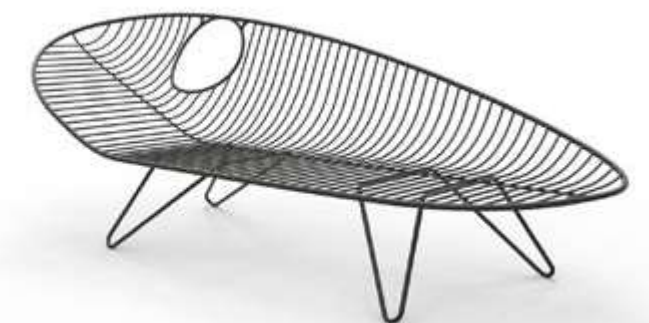



ACCESSORIES

ACCESSORIES

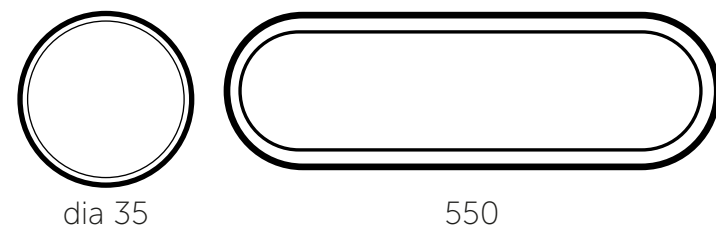

DIMENSIONS		X	Y
sideplate 550	frame: stainless steel lacquered black	550	300
sideplate dia 35	frame: stainless steel lacquered black	dia 35	-

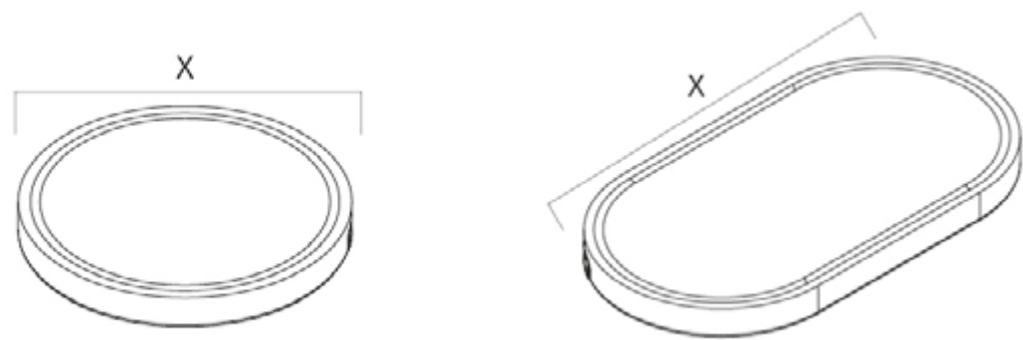

WOOD



oak beech walnut

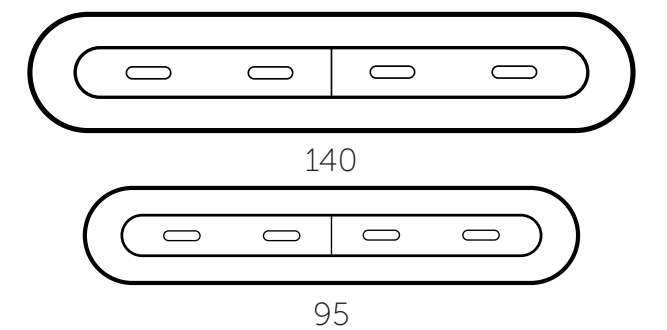

DIMENSIONS		X	Y
plate warmer 140	frame: stainless steel lacquered black	140	20
plate warmer 95	frame: stainless steel lacquered black	95	20

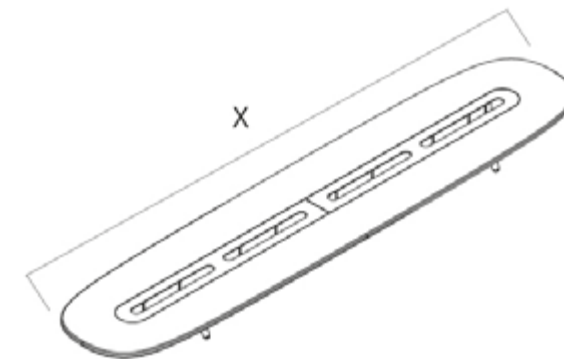

XERAMICA® [page 155]

- 13 mm
- Beton
 - Black Iron
 - Travertino Grey
 - Emperador
 - Lava Brown
 - Marble Marone
- Marble Azuro
 - Caravagio
 - Absolute White
 - Soft Oak
 - Charisma Grey



Heatt dia 60, 45 & 21.

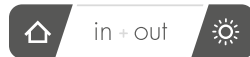

Designed by Lieven Musschoot & Cas Moor

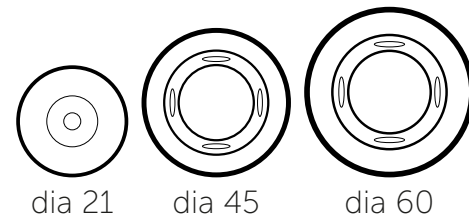

DIMENSIONS

		diameter
plate warmer dia 60	frame: stainless steel lacquered black	60
plate warmer dia 45	frame: stainless steel lacquered black	45
plate warmer dia 21	frame: stainless steel lacquered black	21

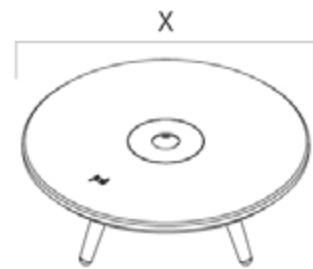

heatt dia 21

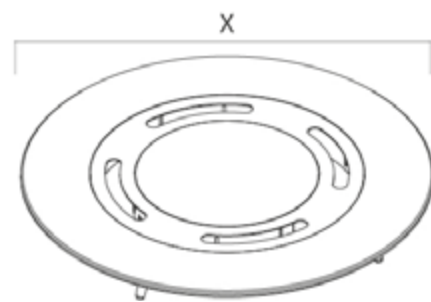

heatt dia 60, 45

XERAMICA® [page 155]

- | | | |
|-------|-------------------|------------------|
| 13 mm | • Beton | • Marble Azuro |
| | • Black Iron | • Caravagio |
| | • Travertino Grey | • Absolute White |
| | • Emperador | • Soft Oak |
| | • Lava Brown | • Charisma Grey |
| | • Marble Marone | |



Turnable Disc.

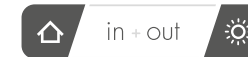

Designed by Lieven Musschoot & Cas Moor

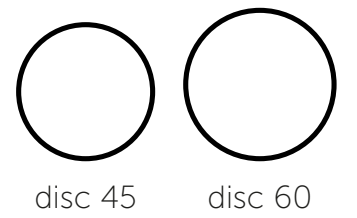

DIMENSIONS

		diameter
turnable disc 60	frame: aluminium	60
turnable disc 45	frame: aluminium	45

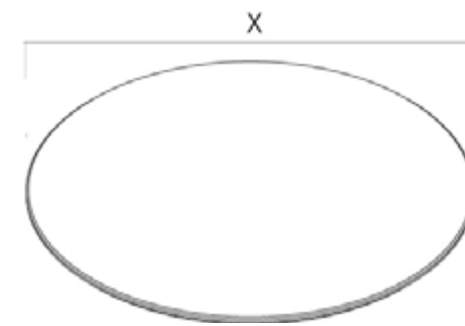

XERAMICA® [page 155]

- | | | |
|----------|-------------------|----------------------------------|
| 6 + 6 mm | • Calacatta | <i>not for extendable models</i> |
| 13 mm | • Beton | • Marble Azuro |
| | • Black Iron | • Caravagio |
| | • Travertino Grey | • Absolute White |
| | • Emperador | • Soft Oak |
| | • Lava Brown | • Charisma Grey |
| | • Marble Marone | |



CABINETS



Your new cabinet, step by step.

You can customise our beautiful cupboards both in size and colour. The options are countless. With the help of this step-by-step plan, we will guide you through the process!

1. Do you want a standing or hanging cabinet?

- A. **Standing** Cube 55, 70, 83 or 193 → See 2A.
- B. **Hanging** Cube 55 or 70 → See 2B.

2. What should be the height of your cabinet?

A. Standing	55 cm <small>(excluding legs)</small>	Cube 55 wall	p. 170
	78 cm <small>(70 + 8 cm finishing bases)</small>	Cube 70	p. 174
	83 cm	Cube 83	p. 177
	91 cm <small>(83 + 8 cm finishing bases)</small>	Cube 83	p. 177
	118 cm <small>(110 + 8 cm finishing bases)</small>	Cube 55 double	p. 172
	148 cm <small>(140 + 8 cm finishing bases)</small>	Cube 70 double	p. 175
	173 cm <small>(165 + 8 cm finishing bases)</small>	Cube 55 triple	p. 173
193 cm	Cube 193	p. 178	
B. Hanging	110 cm	Cube 55 bar or column	p. 171
	140 cm	Cube 70 bar	p. 176
	165 cm	Cube 55 bar or column	p. 171
	220 cm	Cube 55 column	p. 171

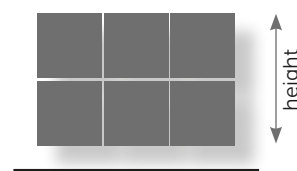

3. Choose the length (and depth). And how many doors and/or drawers would you like?

To see all possibilities go to the page matching the chosen height of your cabinet. Here you will also find the eventual options that correspond with the cabinet.

4. Color inside the Cube:

Melamine



* finish Cosy

5. Color of doors, top and sides:

Matilux® - 4 mm



6. Do you want a top made of Xeramica®? If so, in what color?

See page 155 for more information about the ceramics.



It is not possible for Cube 193 to add a top in Xeramica®.



Cube 55. DOUBLE & TRIPLE

Designed by Chris Vankeirsbilck

- hinge
 - push point
 - cabinet
 - - - adjustable shelves
 - - - fixed partition
 - > rotation direction
- max. load 20 kg / door

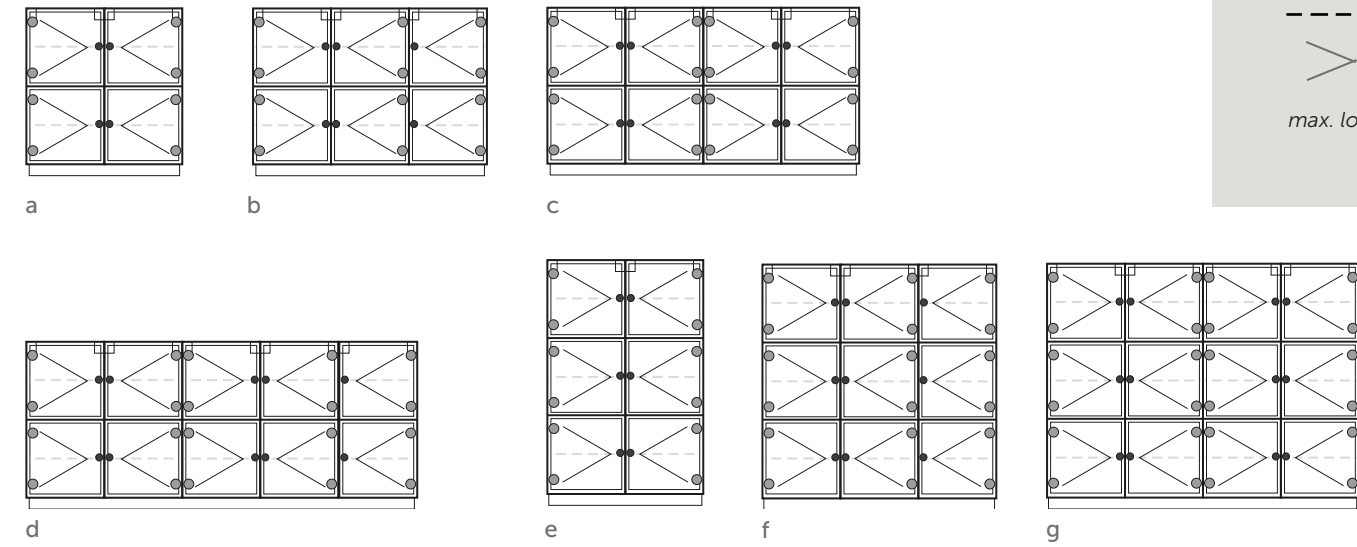

DIMENSIONS

	width	height	depth
a double 4 doors - cabinet + base	110	110	40
b double 6 doors - cabinet + base	165	110	40
c double 8 doors - cabinet + base	220	110	40
d double 10 doors - cabinet + base	275	110	40
e triple 6 doors - cabinet + base	110	165	40
f triple 9 doors - cabinet + base	165	165	40
g triple 12 doors - cabinet + base	220	165	40

OPTIONS

1. 3 drawers instead of 1 door. Position and number of drawer units can be adapted.
2. Door 'vitrine' 55x55 cm clear glass/black frame
3. LED spot (incl. remote control)
4. Space 30 x 55 x 40 not possible at beginning or end cabinet, only between 2 doors

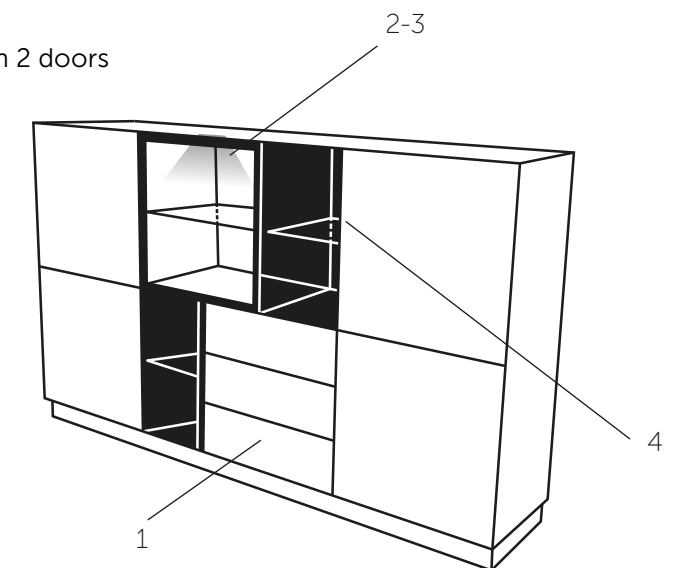



Cube 70. CABINET & DOUBLE

Designed by Chris Vankeirsbilck

- hinge
- push point
- cabinet
- - - adjustable shelves
- - - fixed partition
- > rotation direction

max. load 20 kg / door

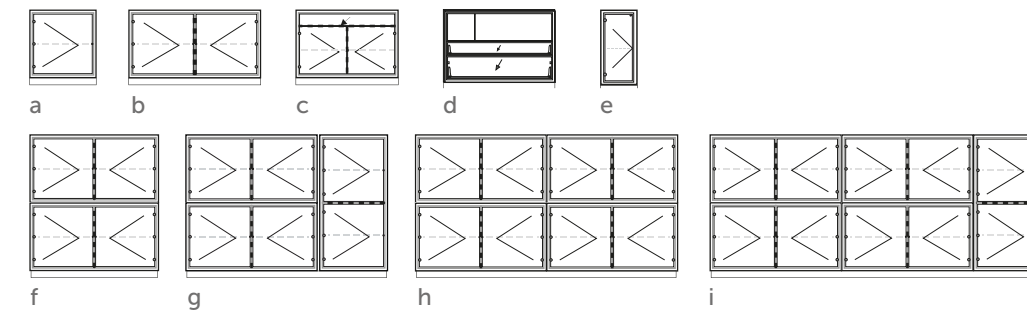

DIMENSIONS

	width	height	depth	code
a 1 door	70	78	40	1D
b 2 doors	140	78	40	2D
c 1 drawer + 2 doors	110	78	40	LDD
d space + 2 doors	110	78	40	SLL
e 1 small door	30	78	40	1SD
f 4 doors	140	148	40	4D
g 6 doors	210	148	40	6D
h 8 doors	280	148	40	8D
i 10 doors	350	148	40	10D

OPTIONS

1. Doors without glass 70/70 cm
2. Doors without glass 55/55 cm
3. Drawer 110 cm wide
4. Drawer 70 cm wide
5. Extra shelf
6. #3 drawers instead of 2 door. Location and quantity of drawerbox free to choose.

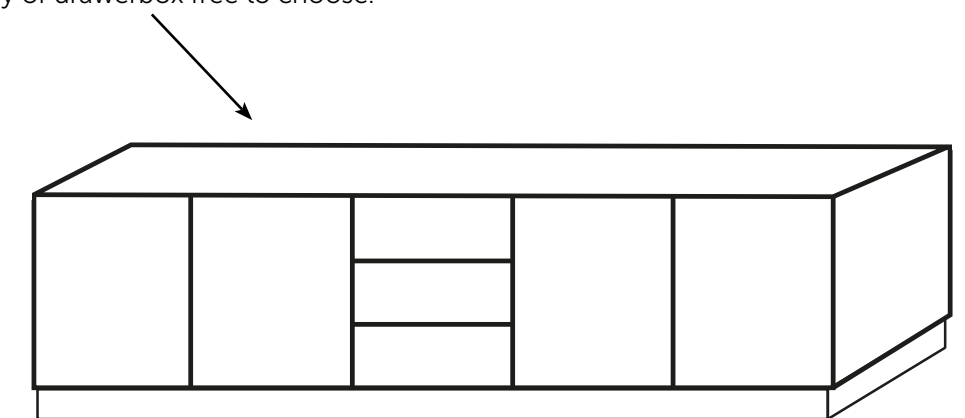

CABINETS



Cube 70. BAR CABINET

Designed by Chris Vankeirsbilck

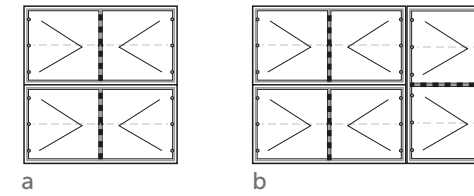

- hinge
 - push point
 - cabinet
 - - - adjustable shelves
 - - - fixed partition
 - > rotation direction
- max. load 20 kg / door*

DIMENSIONS

	width	height	depth	code
a 4 doors	140	140	27	4D
b 6 doors	210	140	27	6D

OPTIONS

1. Doors without glass 70/70 cm
2. Doors without glass 55/55 cm
3. Drawer 110 cm wide
4. Drawer 70 cm wide
5. Extra shelf

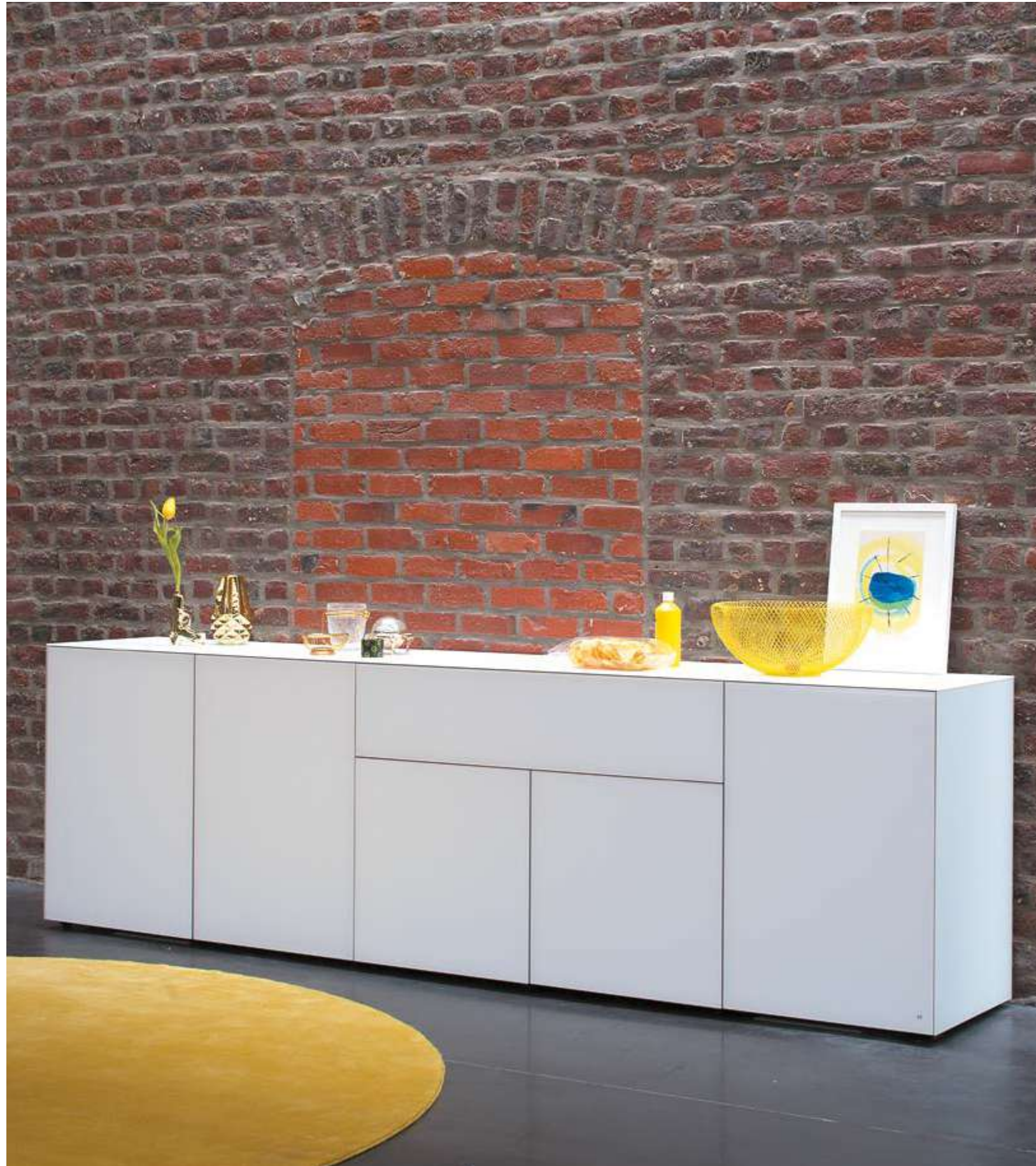

Cube 83. CABINET & DOUBLE

Designed by Chris Vankeirsbilck

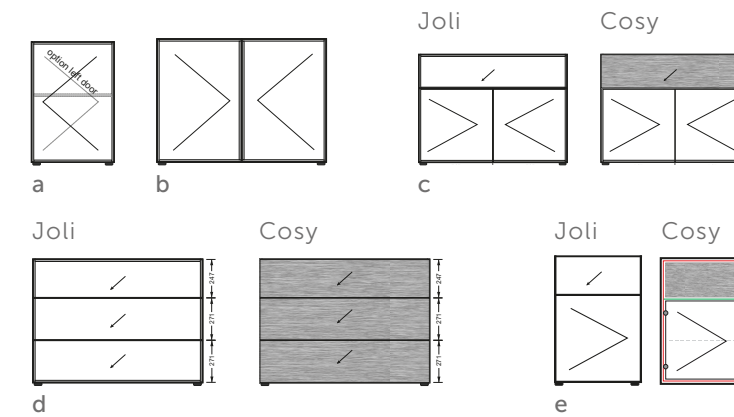

- hinge
 - push point
 - cabinet
 - - - adjustable shelves
 - - - fixed partition
 - > rotation direction
- max. load 20 kg / door

DIMENSIONS	width	height	depth	code
a 1 door	55	83	50	1D
b 2 doors	110	83	50	2D
c 1 drawer + 2 doors	110	83	50	LDD
d 3 drawers	110	83	50	3L
e 1 drawer + 1 door	55	83	50	LD

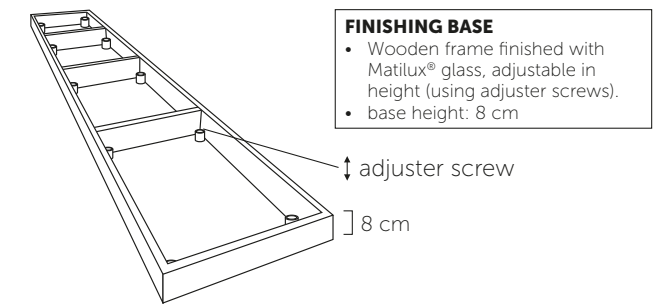

OPTIONS

1. Extra shelf
2. Base in Matilux (height 8 cm) 1 - 3 doors, from 4 doors
3. Black fronts for corpus Joli
4. Matilux glass on drawer instead of wood melamine for corpus Cosy



Cube 193.

Designed by Chris Vankeirsbilck

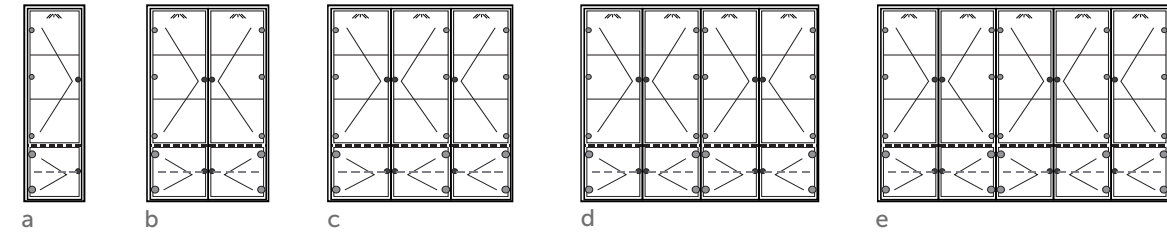

- hinge
 - push point
 - cabinet
 - - - adjustable shelves
 - - - fixed partition
 - > rotation direction
- max. load 20 kg / door

DIMENSIONS

	width	height	depth
a 1 door	55	193	40
b 2 doors	110	193	40
c 3 doors	165	193	40
d 4 doors	220	193	40
e 5 doors	275	193	40

OPTIONS

1. Extra shelves wood or glass



MAINTENANCE



Glass clean.

Glass clean does not leave scratches and is therefore most suitable for cleaning matt glass, ceramics and stainless steel. This makes it the perfect agent for treating aggressive grease marks or tough dirt on Matilux®, even surface rust on stainless steel (brown spots).



All clean.

Powerful, versatile and safe cleaner for all applications, indoor and outdoor. Removes grease, dirt and green soiling. Cleans: garden furniture, faux leather, table tops, textile fabric covers and tarpaulin.



Textile protector.

This is a high-performance protection product for upholstery textiles. The dirt-repellent layer means that food and drinks will not leave stains. This will ensure that your furniture lasts for many years without stains.



TABLE TOPS & FABRICS

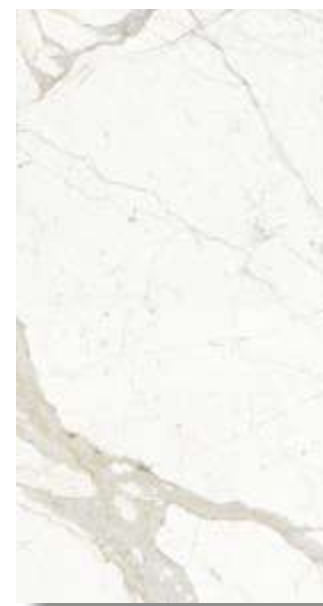

Calacatta
6 + 6 mm



Emperador
13 mm



Black Iron
13 mm



Lava Brown
13 mm

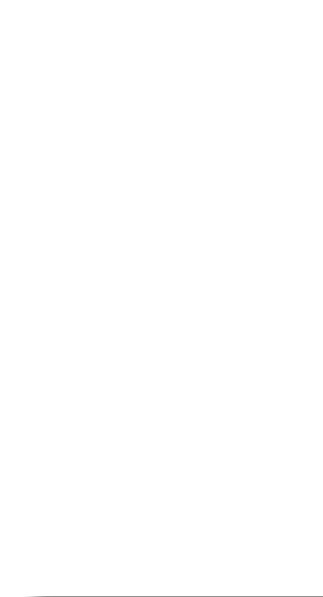

Absolute White
13 mm



Beton
13 mm



Marble Marone
13 mm



Marble Azuro
13 mm



Caravaggio
13 mm



Travertino Grey
13 mm



Soft Oak
13 mm



Charisma Grey
13 mm

Easy care fabrics



Tabacco



Truffle



Stone



Flax

Corallo

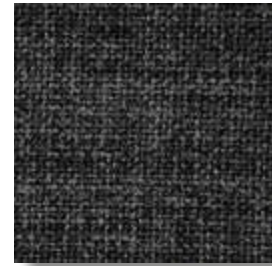

Charcoal



Beige



Cherry



Blue

Leather

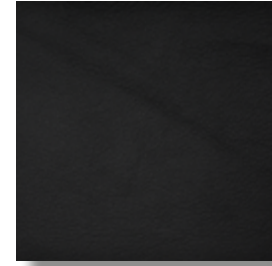

Black

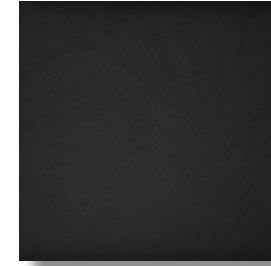

Antracite

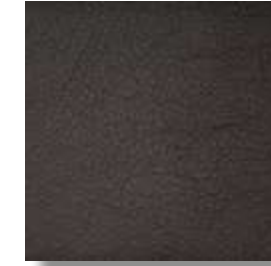

Nutella

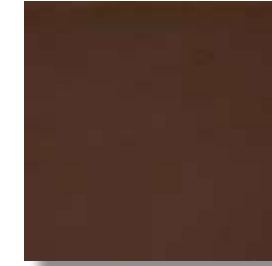

Cognac



Pearl

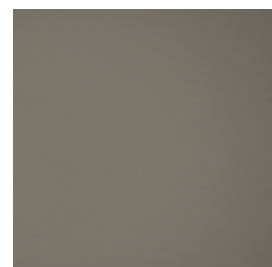

Beige



Taupe

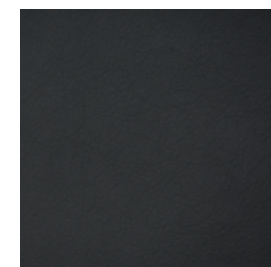

Grey



White

Velvet



Black



Beige



Blue

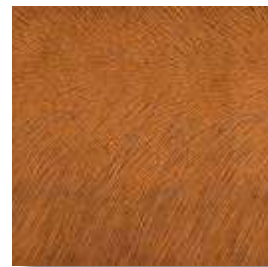

Orange



Green

Smooth



Ash



Sooty



Canvas



Tagine

Vegan leather (skai)

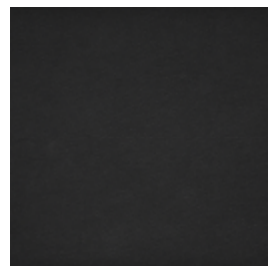

Black



Antracite



Dark Brown

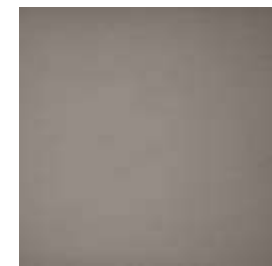

Taupe

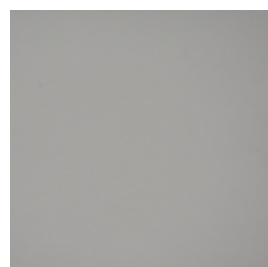

Lino



White



Cognac

Nautic Linen



Carbon



Pepper



Earth

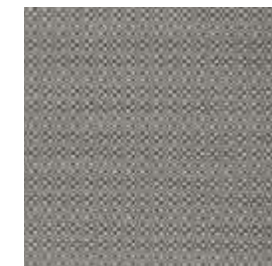

Sand



Salt



Sahara



Bamboo



Ocean

TABLE TOPS

Xeramica® consist of minerals that are pressed together under high pressure and at high temperature to form a very dense, homogeneous structure.

Advantages

- no scratches
- 100% UV resistant
- absorbes no grease, acid, water and wine
- 100% resistant to frost
- no more greasy fingers
- no visible dust
- indoor and outdoor use
- easy maintenance

Xeramica® - 6 + 6 mm

This is a ceramic plate of 6 mm laminated onto a pane of 6 mm tempered glass. The maximum width is 150 cm.

Xeramica® - 13 mm



Xeramica® 13 mm is a full ceramic plate, with fiber-glass membrane underneath. The maximum width is 150 cm.

Photography: Frederik Verduyck,
Bieffe & Beeldcollectief
Graphic design: Unik Concepts

JOLI Head office
Industrielaan 5, 8520 Kuurne - Belgium
Tel. +32 (0)56 37 27 16 - info@joli.be



www.joli.be

  @joli_belgium