

jardinico[®]

ATTITUDE & DECORATION
OUTDOOR SHADE 2022

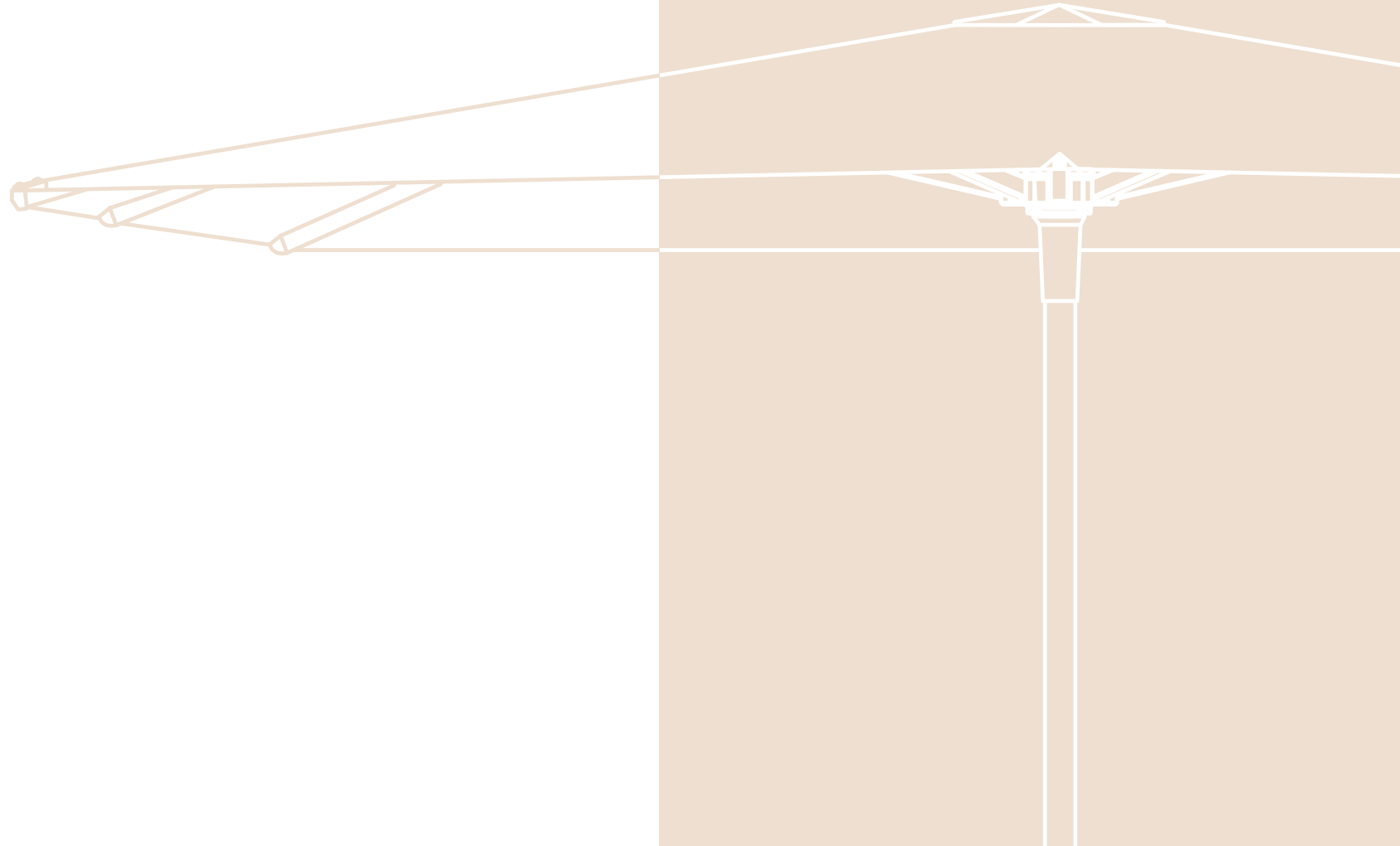

jardinico[®]



SURROUNDED BY
a touch of
SHADE

Our aim is to create the space you live in outside. We are a Belgian brand that open doors to the perfect exterior by adding unique and exclusive pieces to your garden or terrace. We want to inspire you and take you to the outdoor experience of your dreams. A serene place where you come together and experience blissful moments with your beloved ones. Complement the outdoors flawlessly with quality materials, the best comfort and finest design.

Our strengths lie in the scope and diversity of our collections. By an allround view on your outdoor area, we are able to offer everything from the best umbrella to your dining table, sunloungers and desired accessories. The Attitude collection includes outdoor umbrellas to suit everyone's preferences. A mid or free pole umbrella, wood or aluminum and a range of available colours for your canopy.

PRODUCT TYPE

Free pole aluminium	
Azore	94
Antego	96
Kingston	98
Mid pole aluminium	
Amalfi	100
Malibu	102
Mid pole wood	
Cuba	104
Moorea	106
Bases	108
Accessories	119
Lighting	110
Pots	111
Rugs	112
Poufs	113

AZORE

Gallery	9
Technical	94

ANTEGO

Gallery	13
Technical	96

KINGSTON

Gallery	23
Technical	98

AMALFI

Gallery	33
Technical	100

MALIBU

Gallery	43
Technical	102

CUBA

Gallery	51
Technical	104

MOOREA

Gallery	57
Technical	106

DECORATION

Gallery	63
Technical	110

SPECIFICATIONS

Technical	93
Materials	115
Protection & maintenance	121



Azore makes its first appearance in our collection this year. Tilt the umbrella in height with a self locking tooth belt system at the back of its pole or tilt left and right by means of the lever.

The pedal at the bottom of the pole allows you to rotate the umbrella 360° around its axis. Choose a colour combination to your preference and enjoy sufficient shade on all sunny days, wherever you want on your terrace.

AZORE

free pole

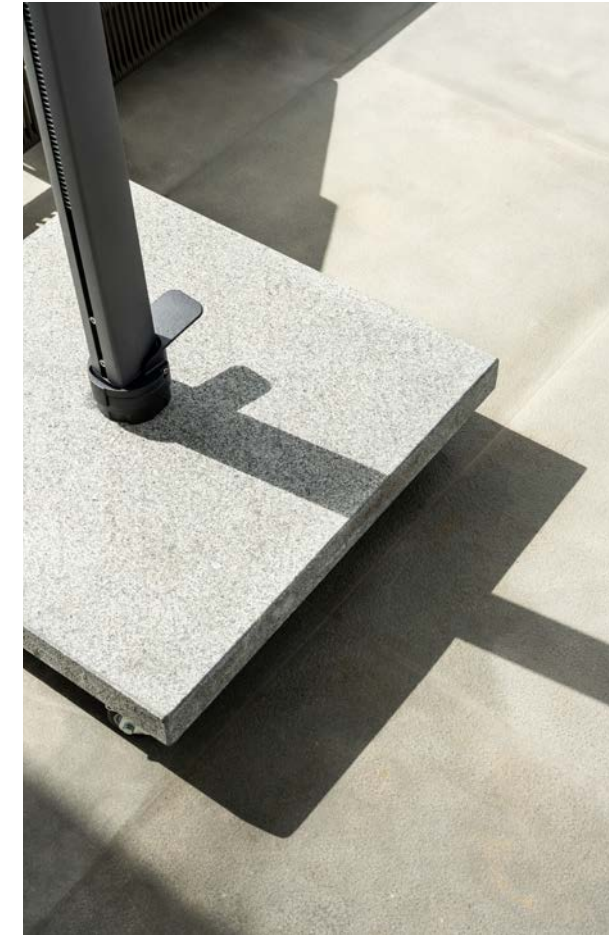



ANTEGO

free pole

Antego offers everything you expect from an outdoor umbrella and does not disappoint. Its operating system allows you to easily move and tilt your umbrella in any desired direction.

This outdoor umbrella is developed to complement any outdoor area and give the protection you need all summer long.



DONUT poufs

ANTEGO ø 350 cm A32 black C208 black with black concrete base



ANTEGO 300 x 200 cm A03 linen C010 latte with linen concrete base





The Antego base is available in granite, sandstone, concrete and marble. It offers an enormous ease of use. Despite its weight of 125 kg - 275.6 lbs, the base can easily be moved on your patio. If desired, you may provide extra support by adding two extra granite tiles of 30 kg - 66 lbs each as shown above.



ANTEGO 300 x 300 cm A01 white C001 natural with white marble base VOLTE dining



ANTEGO ø 300 cm A01 white C001 natural with silk grey granite base

BAY poufs



Kingston is known for its sturdy design and heavy granite base of 300 kg. A large umbrella with a twelve or sixteen square metre canopy that can perfectly cover your entire lounge set and large terrace. The aluminium powder coated frame comes in three colour finishes and a number of colours for its canopy, depending on your preference.

KINGSTON

free pole

KINGSTON 400 x 400 cm A32 black C208 black with silk grey granite base
NATURE dining with TUGU armchairs
ARCO lanterns





Kingston is supported by a 300 kg base. The renewed base has rounded corners providing an elegant and tasteful look to the enormous and robust umbrella.







This outdoor umbrella is known as Amalfi. The perfect intermediate, scaled to fit both smaller to large scale areas. A design that spreads a luxurious appearance and gives the ultimate feeling of comfort.

A strong umbrella, developed to withstand inclement weather conditions and a perfect fit for any allround use. Choose a colour and finish to your heart's content and enjoy the outdoors.

AMALFI

mid pole



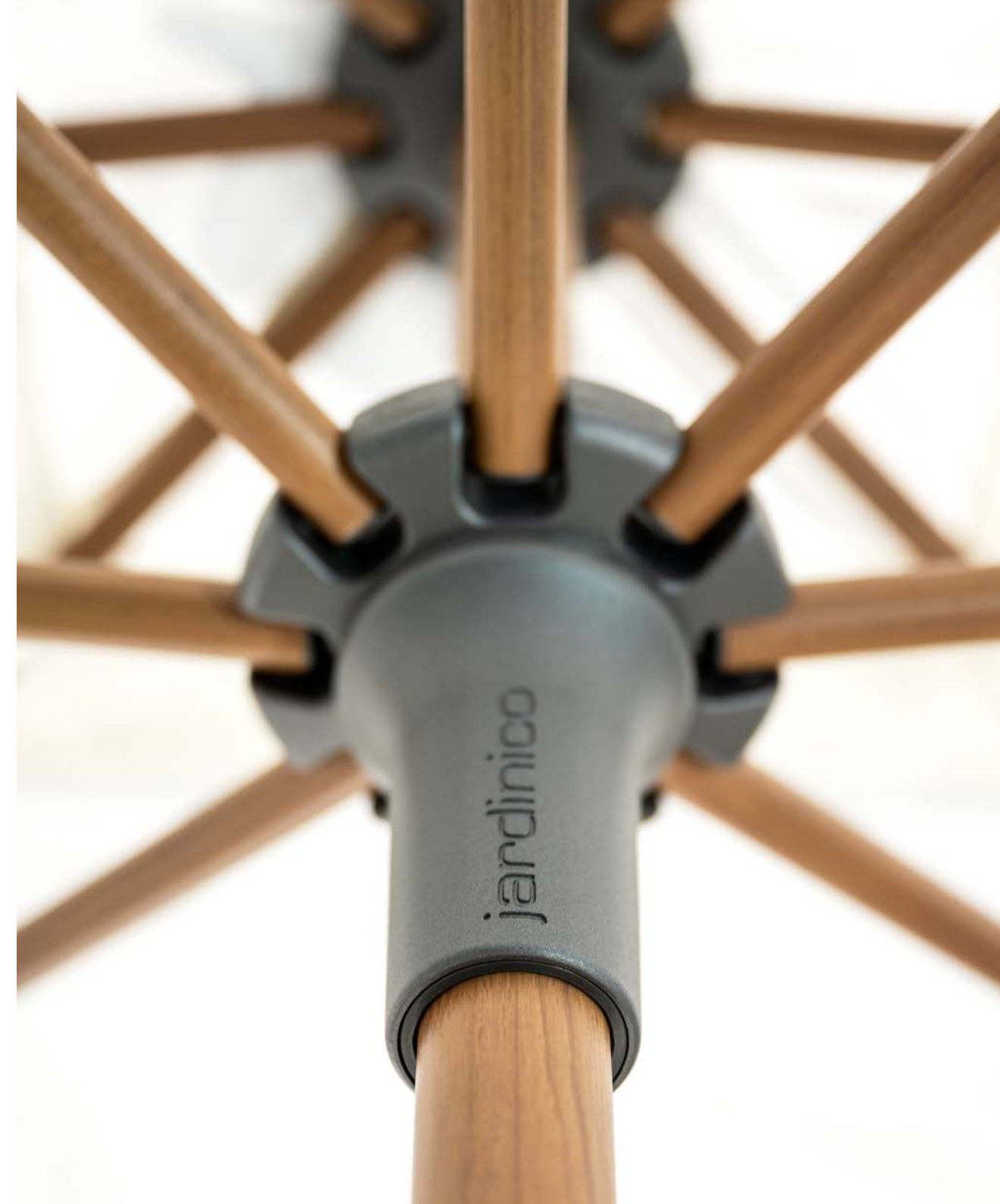

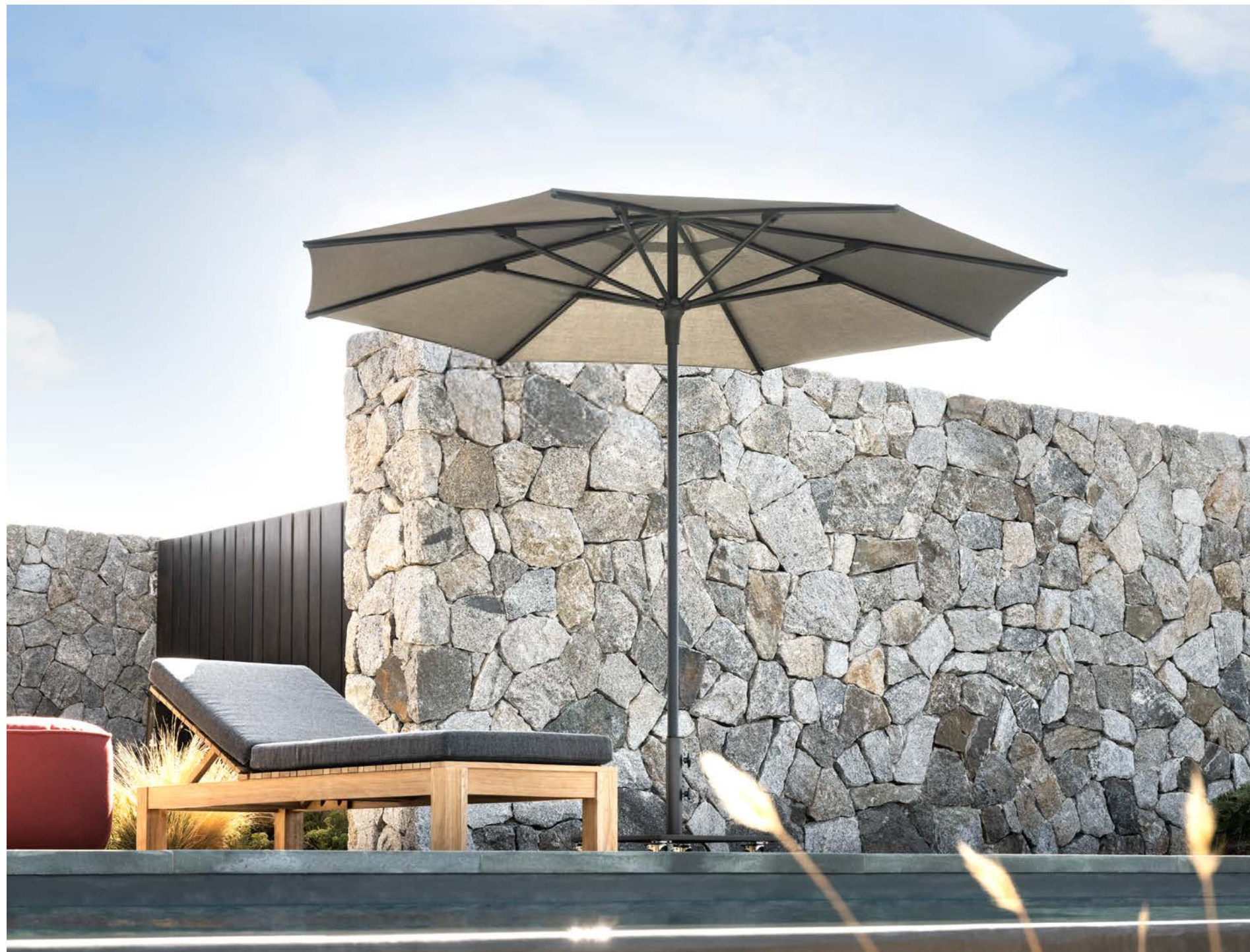



AMALFI 300 x 300 cm A30 anthracite C106 gris nature

Protection from direct sunlight is increasingly becoming an essential prerequisite for us to enjoy the outdoors, indispensable for our health and well-being. Amalfi shows very slim, elegant lines and fits seamlessly into the design of modern urban landscapes, leisure resorts and private homes.



AMALFI 250 x 250 cm A12 alu teak C001 natural

AMALFI ø 300 cm A30 anthracite C204 night



The parasol owes the sturdiness you need to its full aluminium frame. Our Amalfi design has been thoroughly tested to withstand various weather conditions around the globe.



MALIBU

mid pole

A light and practical umbrella, ideal for every smaller terrace or along the swimming pool. You can determine the shade by tilting the umbrella, depending on the position of the sun.

Malibu is here for everyone as we offer fourteen different colour combinations, next to six available sizes in a round, square and a rectangular shape. The umbrella is adjustable in height and has a powder coated aluminium frame with a water-repellent canopy.









CUBA

mid pole

Cuba is a timeless classic in the Attitude collection. It shows wood craftsmanship with stainless steel, corrosion proof parts.

This umbrella shows its beauty around the globe and is developed to withstand tough, windy conditions in tropical climates.



CUBA ø 350 cm W60 eucalyptus C301 taupe





MOOREA

mid pole

An umbrella that is constructed to perform faultlessly and will grace your garden by its sleek and elegant touch. Moorea is finished by a scratched teak frame for a natural and rough finish, including a cord pulley to smoothly open and close the umbrella.

You are able to enjoy the perfect shade for many years to come because of a high performance and protective canopy. Moorea features a heavy duty frame with a diameter of 55 mm and is available with multiple base options.



FLEXX sunloungers

MOOREA 300 x 300 cm W63 teak scratched C002 white with Elba base heavy

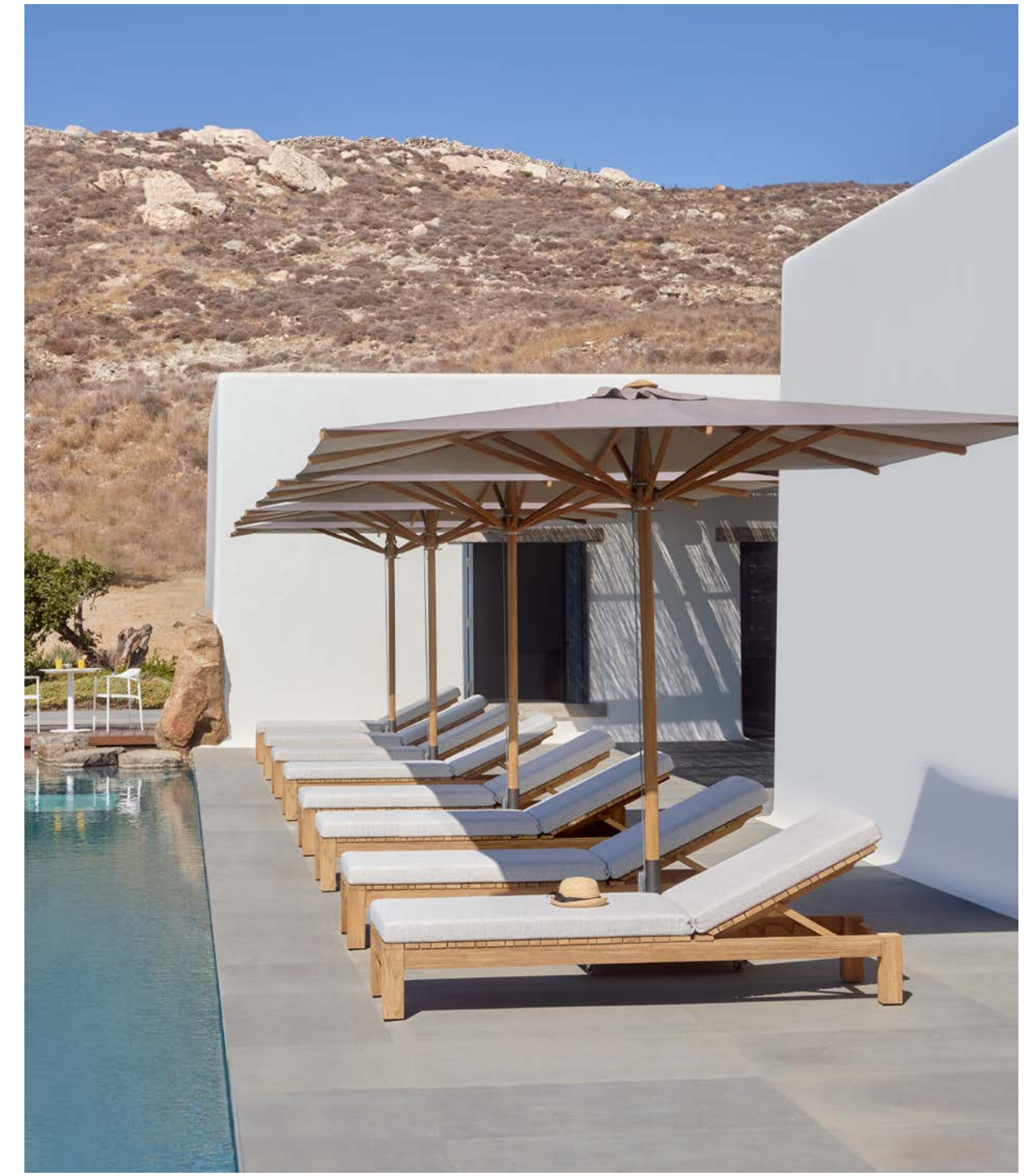

MOOREA 300 x 300 cm W63 teak scratched C301 taupe

TECCA sunloungers



striking ACCESSORIES

No outdoor area is complete without a striking accessory. A soft candle light to set a mood once the sun sets, a heavy duty outdoor rug or some poufs that match your furniture cushions perfectly. Choose any size, material or fabric that suits your style and let our range of decoration items add the finishing touch you envisioned to your garden and terrace.



ARCQ lanterns small, large



The beautiful, handwoven wicker creates a playful pattern between light and shadow. They allow light to filter through and cast a warm, natural glow around them. The module with a solar panel on top ensures that the light switches on when evening falls. Arcq lanterns undoubtedly bring cosiness outdoors.



SOLORE lighting cube medium, small and large F17 taupe



SOLORE lighting sphere medium, small F15 natural



INTEGRA lanterns medium, small and large



ANTIBES lanterns small, medium and large





ø 91 x 56 cm - 36 x 22"



ø 112 x 67 cm - 44 x 26"



TERRA pot balloon 112 high P03 sabbia



TERRA pots high, mid P11 macchiato



TERRA pots balloon 55 mid, high and low P32 nero



CUMINO pot 144 low P01 panna



Create a serene and private oasis with Cumino. Contemporary design with rounded lines, timeless colours and embraced by natural materials. The collection is frost-resistant and makes a statement by its leading shape.



An ultra thin premium rug that perfectly complements any outdoor space. Wilson rugs are made in Belgium and combine two yarns with a woven structure. The rugs are manufactured from 40% wool, 40% HSPP frise and 20% polyester.

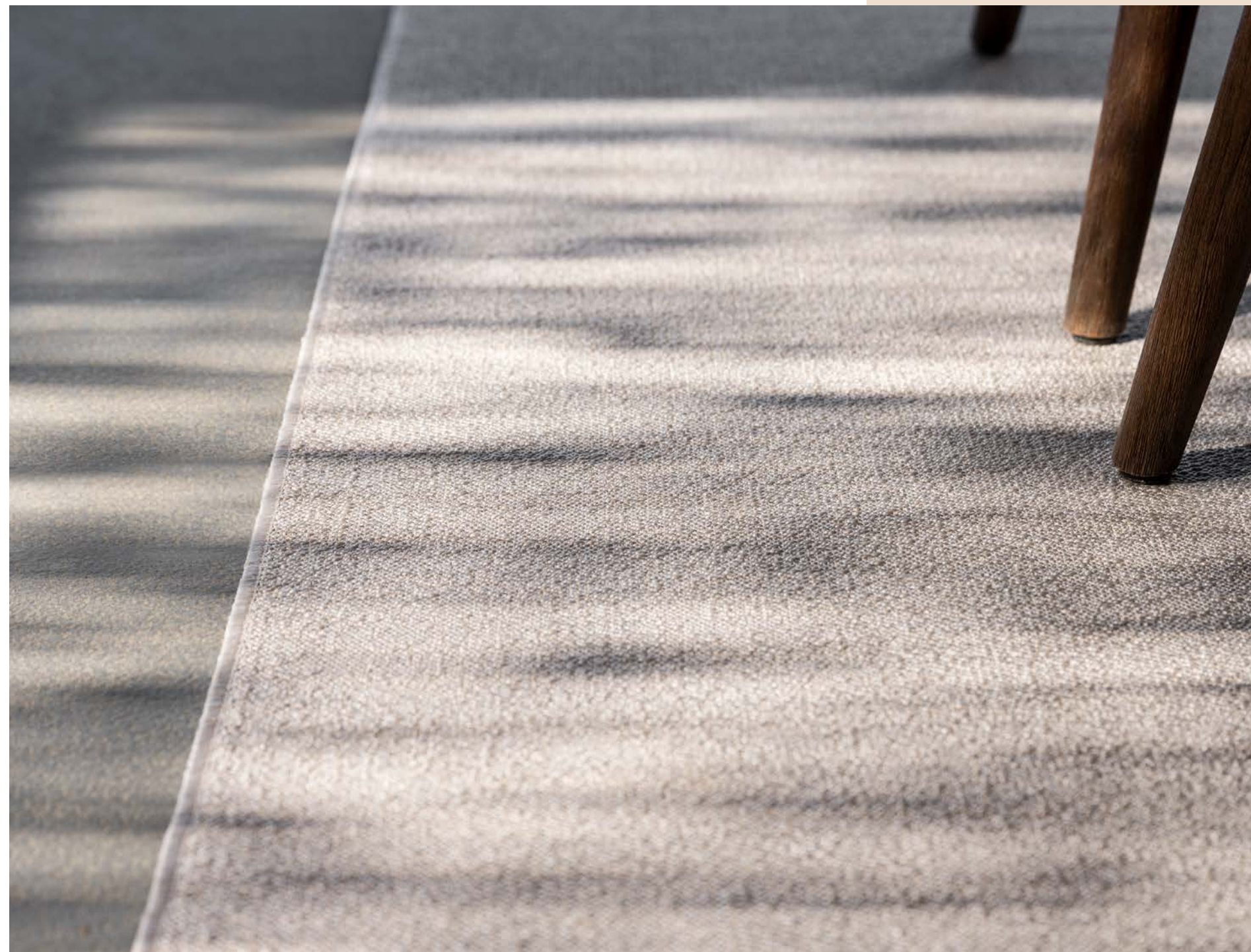

WILSON rug D78 oyster



JUTE rug D82 jute



VASCO rug D85 aqua D84 charcoal



LONGI rug D80 ecru



ø 50 x 40 cm - 19 x 16"



ø 50 x 50 cm - 19 x 19"



ø 80 x 40 cm - 32 x 16"



BAY poufs small, medium and large







DONUT poufs small, large



ANTIBES winetub and winecooler



Technical SPECIFICATIONS

The representation of colours, dimensions and weights may differ from reality as may variations when a product is handmade. Dimensions and technical details are subject to change without prior notice. Jardinico reserves the right to make any improvements such as technological and aesthetical modifications to its models, including adjustments of sizes and materials when it comes to technical developments or availability of raw materials.

More information, accompanying videos about the collections and technical data sheets of each product can always be consulted or downloaded on our website www.jardinico.com.



AZORE

NEW

300 x 300 cm

FRAME

Free pole umbrella with crank handle. Pole and ribs are aluminium powder coated.

TILT & ROTATION

Tilt in height, left and right. 360° rotation around the pole by means of a pedal at the bottom of the frame.

WIND SPEED

27 km/h, 17 mph - Maximum wind speed to which the umbrella may be exposed.

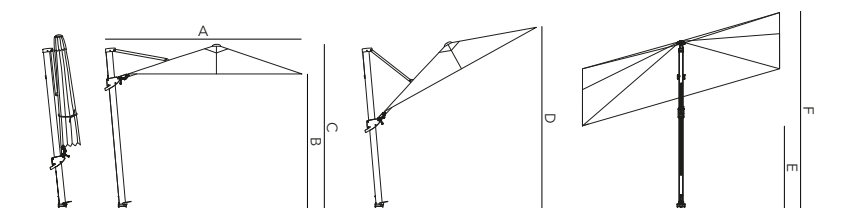

300 X 300 CM	
	27 kg - 59.5 lbs nett excl. base
A	343 cm - 135"
B	228 cm - 89.8"
C	260 cm - 102.4"
D	330 cm - 129.9"
E	146 cm - 57.5"
F	317 cm - 124.8"



AZORE

UMAZO FRAME & CANOPY

		A01C101 white & cloud
		A30C204 anthracite & night
		A32C208 black & black

UB BASE

	AZO-125-G04 azore
--	-------------------

in ground base

on ground base

ACCESSORIES

UPAZO-M-X75 protection cover

UALUN-LED02 luna LED light



UBAZO-125-G04
AZORE
SILK GREY GRANITE

125 kg, 275.6 lbs
80 x 80 x 7 cm
31.5 x 31.5 x 2.2"
incl. wheels



IN GROUND BASE

8.4 kg, 18.5 lbs
ø 21.5 x 51 cm, 8.5 x 20.1"
steel



ON GROUND BASE

8 kg, 17.6 lbs
ø 7 x 67 cm, 2.8 x 26.4"
steel



ANTEGO

300 x 200 cm

300 x 300 cm

ø 350 cm

360°



FRAME

Free pole umbrella with crank handle. Pole and ribs are aluminium powder coated.

TILT & ROTATION

Tilt in height, left and right. 360° rotation around the pole by means of a pedal at the bottom of the frame.

WIND SPEED

39 km/h, 24 mph - Maximum wind speed to which the umbrella may be exposed.

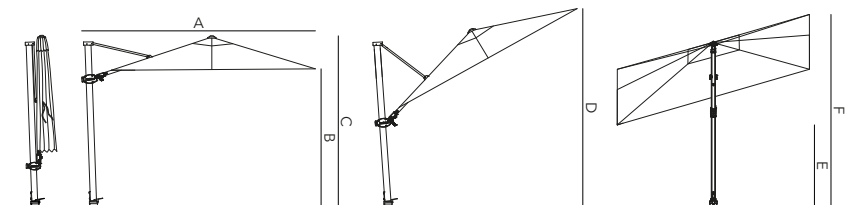

	300 X 200 CM	300 X 300 CM	Ø 350 CM
	33 kg - 72.8 lbs nett excl. base	34 kg - 75 lbs nett excl. base	35 kg - 77.1 lbs nett excl. base
A	275 cm - 108.3"	375 cm - 147.6"	427 cm - 168.1"
B	203 cm - 79.9"	203 cm - 79.9"	188 cm - 74"
C	262 cm - 103.1"	262 cm - 103.1"	261 cm - 102.8"
D	280 cm - 110"	355 cm - 139.8"	441 cm - 173.6"
E	130 cm - 51.2"	130 cm - 51.2"	130 cm - 51.2"
F	300 cm - 118.1"	300 cm - 118.1"	375 cm - 92.5"



BESTSELLERS



A01C101
white & cloud



A11C301
taupe & taupe



A12C001
alu teak & natural

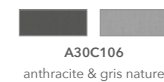

A30C106
anthracite & gris nature



A30C204
anthracite & night



A32C208
black & black

ANTEGO

UFANT FRAME

	A01 white		A02 silver*
	A03 linen		A11 taupe
	A12 alu teak		A30 anthracite
	A32 black		

*only available in 300 x 300 cm

UCANT CANOPY CLASSIC

	C001 natural		C101 cloud
	C106 gris nature		C204 night
	C208 black		C301 taupe

UCANT CANOPY PREMIUM

	C010 latte		C211 steel
	C304 walnut		

	C402 tangerine		C409 brick
	C417 jeans		C424 spinach

Free pick: Other fabrics available upon request.

UB BASE

	UBANT-125-G04 silk grey granite
	OPTIONAL UBANT-EW100-G04 silk grey granite tiles
	UBANT-125-G13 sandstone
	UBANT-125-G32 black granite
	UBANT-125-B03 / B32 concrete base
	UBANT-125-M01 white marble

UBIGB-FP-MEDIUM in ground base

UBFFP-FP-MEDIUM on ground base

ACCESSORIES

UPANT-M-X75 protection cover

UALUN-LED02 luna LED light



UBANT-125-G04
SILK GREY GRANITE

125 kg, 275.6 lbs
92.5 x 92.5 x 5 cm
36.4 x 36.4 x 2"
incl. wheels
optional: tiles



UBANT-125-G13
SANDSTONE

125 kg, 275.6 lbs
92.5 x 92.5 x 5 cm
36.4 x 36.4 x 2"
incl. wheels



UBANT-125-G32
BLACK GRANITE

125 kg, 275.6 lbs
92.5 x 92.5 x 5 cm
36.4 x 36.4 x 2"
incl. wheels



UBANT-125
CONCRETE

125 kg, 275.6 lbs
92.5 x 92.5 x 6.5 cm
36.4 x 36.4 x 2.5"
incl. wheels
B03 linen B32 black



UBANT-125-M01
WHITE MARBLE

125 kg, 275.6 lbs
92.5 x 92.5 x 5 cm
36.4 x 36.4 x 2"
incl. wheels



UBIGB-FP-MEDIUM
IN GROUND BASE

5.7 kg, 12.6 lbs
ø 21.5 x 51 cm, 8.5 x 20.1"
steel



UBFFP-FP-MEDIUM
ON GROUND BASE

8 kg, 17.6 lbs
ø 21.5 x 1.2 cm, 8.5 x 0.5"
steel

ANTEGO



KINGSTON

UPDATED

400 x 300 cm

400 x 400 cm

FRAME

Free pole umbrella with crank handle at the bottom of the mast. Pole and ribs are aluminium powder coated.

TILT & ROTATION

Tilt in height. 360° rotation.

WIND SPEED

45 km/h, 28 mph - Maximum wind speed to which the umbrella may be exposed.

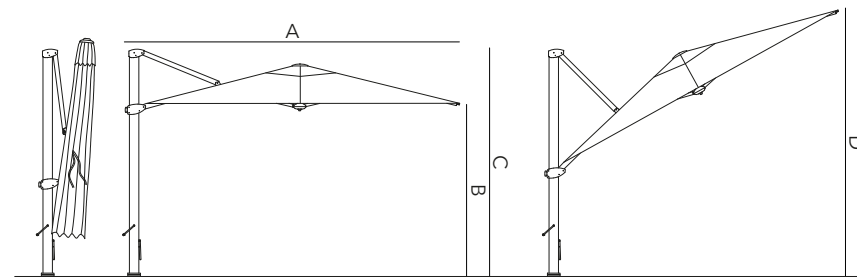

	400 X 300 CM	400 X 400 CM
	46 kg - 101.4 lbs nett excl. base	54 kg - 119 lbs nett excl. base
A	364 cm - 106.7"	464 cm - 182.7"
B	240 cm - 94.5"	240 cm - 94.5"
C	290 cm - 114.2"	290 cm - 114.2"
D	384 cm - 151.2"	364 cm - 143.3"

360°



BESTSELLERS



KINGSTON

UFKIN FRAME

	A01 white		A30 anthracite
	A32 black		

UCKIN CANOPY CLASSIC

	C001 natural		C101 cloud
	C106 gris nature		C204 night
	C208 black		C301 taupe

UCKIN CANOPY PREMIUM

	C010 latte		C211 steel
	C304 walnut		C402 tangerine
	C409 brick		C417 jeans
	C424 spinach	Free pick: Other fabrics available upon request.	

UB BASE

	KIN-300-G4 silk grey granite
IGB-FP-LARGE in ground base	
OGB-FP-LARGE on ground base	

ACCESSORIES

UPKIN-L-X75 protection cover
UALUN-LED02 luna LED light

UPDATED



UBKIN-300-G04
SILK GREY GRANITE

300 kg, 661.4 lbs
100 x 100 x 10 cm
36.4 x 36.4 x 2"
incl. wheels



UBIGB-FP-LARGE
IN GROUND BASE

8.4 kg, 18.5 lbs
ø 25 x 51 cm, 9.8 x 20"
steel



UBOGB-FP-LARGE
ON GROUND BASE

8 kg, 17.6 lbs
ø 21.5 x 1.2 cm, 8.5 x 0.5"
steel

KINGSTON



AMALFI

UPDATED

250 x 250 cm

300 x 300 cm

ø 300 cm

NEW

NEW

FRAME

Mid pole umbrella.
Diameter of the pole: ø 40 mm, 0.16".
Pole and ribs are aluminium powder coated.

TILT & ROTATION

Not applicable.

WIND SPEED

39 km/h, 24 mph - Maximum wind speed to which the umbrella may be exposed.

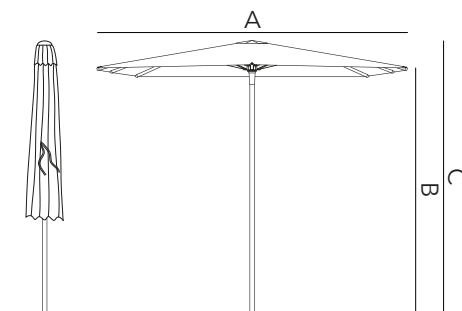

	250 X 250 CM	300 X 300 CM	Ø 300 CM
	14.9 kg - 32.8 lbs nett excl. base	17 kg - 37.5 lbs nett excl. base	17 kg - 37.5 lbs nett excl. base
A	250 cm - 98.4"	300 cm - 118.1"	300 cm - 118.1"
B	216 cm - 85"	216 cm - 85"	216 cm - 85"
C	250 cm - 98.4"	250 cm - 98.4"	250 cm - 98.4"

BESTSELLERS



AMALFI

UFAMA FRAME

	A01 white		A03 linen	NEW
	A12 alu teak		A30 anthracite	
	A32 black			

UCAMA CANOPY CLASSIC

	C001 natural		C101 cloud	
	C106 gris nature		C204 night	
	C208 black		C301 taupe	

UCAMA CANOPY PREMIUM

	C010 latte		C211 steel	
	C304 walnut			

	C402 tangerine		C409 brick
	C417 jeans		C424 spinach

Free pick: Other fabrics available upon request.

UB BASE

	ELB-44-S01 / -S03 / -S31 elba medium
--	--------------------------------------

IGB-MP-SMALL in ground base

OGB-MP-SMALL on ground base

ACCESSORIES

UPAMA-M-X75 protection cover

UALUN-LED02 luna LED light



UBELB-44 ELBA MEDIUM STEEL

44 kg, 97 lbs
54.5 x 54.5 x 1.8 cm,
21.5 x 21.5 x 0.7"
incl. wheels

S01 white, S03 linen, S31 charcoal



UBIGB-MP-SMALL IN GROUND BASE

1 kg, 2.2 lbs
ø 7 x 72 cm
2.8 x 28"
anodised aluminium

AMALFI



MALIBU

UPDATED

210 x 150 cm

200 x 200 cm

250 x 200 cm

240 x 240 cm

∅ 250 cm

∅ 300 cm

FRAME

Mid pole umbrella.
Diameter of the pole: ∅ 38 mm, 1.5".
Pole and ribs are aluminium powder coated.
Flexible rib ends.

TILT & ROTATION

Can be tilted.
Adjustable height.

WIND SPEED

12 km/h, 7.5 mph - Maximum wind speed to which the umbrella may be exposed.

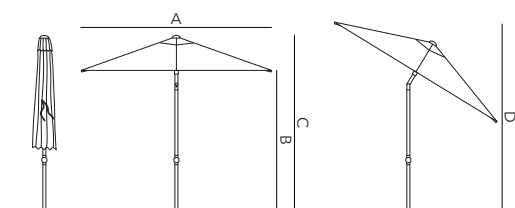

	210 X 150 CM	200 X 200 CM	250 X 200 CM
	5 kg - 11 lbs nett excl. base	6 kg - 13.2 lbs nett excl. base	6 kg - 13.2 lbs nett excl. base
A	210 cm - 82.7"	200 cm - 78.7"	250 cm - 98.4"
B	195 cm - 76.8"	195 cm - 76.8"	195 cm - 76.8"
C	255 cm - 100.4"	255 cm - 100.4"	255 cm - 100.4"
D	245 cm - 96.5"	253 cm - 99.6"	255 cm - 100.4"

	240 X 240 CM	∅ 250 CM	∅ 300 CM
	7 kg - 15.4 lbs nett excl. base	5.5 kg - 12.1 lbs nett excl. base	7.2 kg - 15.9 lbs nett excl. base
A	240 cm - 94.5"	250 cm - 98.4"	300 cm - 118.1"
B	195 cm - 76.8"	195 cm - 76.8"	195 cm - 76.8"
C	255 cm - 100.4"	255 cm - 100.4"	255 cm - 100.4"
D	260 cm - 102.4"	255 cm - 100.4"	275 cm - 108.3"

MALIBU

UMMAL FRAME & CANOPY

		A01C002 white & white	
		A01C105 white & light grey	NEW
		A01C418 white & ocean	
		A01C421 white & kiwi	
		A12C002 alu teak & white*	NEW
		A12C109 alu teak & speckle*	NEW
		A30C002 anthracite & white	
		A30C105 anthracite & light grey	NEW
		A30C109 anthracite & speckle	
		A30C200 anthracite & dark grey	
		A30C302 anthracite & mocca	
		A30C405 anthracite & orange	
		A30C407 anthracite & red	
		A32C209 black & coal	

*Only available in ∅ 300 cm, 250 x 200 cm, 240 x 240 cm.

UB BASE

	LON-35 london
	CHI-50 chicago
	LUC-25-B01 / -B30 lucca half
	LUC-35-B01 / -B30 lucca light
	OPTIONAL UALUC-WHE.35 lucca light wheels
	ELB-28-S01 / -S31 elba light

IGB-MP-SMALL in ground base

OGB-MP-SMALL on ground base

ACCESSORIES

UPUMB-S-X75 protection cover

UALUN-LED02 luna LED light



UBLON-35
LONDON
CONCRETE

35 kg, 77.2 lbs
∅ 50 cm, 19.7"
black
incl. wheels



UBCHI-50-B32
CHICAGO
CONCRETE

50 kg, 110.2 lbs
∅ 50 cm, 19.7"
black
incl. wheels



UBLUC-25
LUCCA HALF
CONCRETE

25 kg, 55.1 lbs
51 x 29 x 8 cm
20 x 7 x 3.1"
B01 white, B30 anthracite



UBLUC-35
LUCCA LIGHT
CONCRETE

35 kg, 77.2 lbs
45 x 45 x 8.5 cm
17.7 x 17.7 x 3.3"
B01 white, B30 anthracite
optional: wheels



UBELB-28
ELBA LIGHT
STEEL

28 kg, 63.9 lbs
49 x 49 x 1.6 cm
19.3 x 19.3 x 0.6"
incl. wheels
S01 white, S31 charcoal



UBIGB-MP-SMALL
IN GROUND BASE

1 kg, 2.2 lbs
∅ 7 x 72 cm
2.8 x 28"
anodised aluminium





CUBA

300 x 300 cm

400 x 400 cm

ø 350 cm

FRAME

Mid pole umbrella.
Diameter of the pole: ø 61 mm, 2.4".
Eucalyptus wood, natural finishing,
with stainless steel parts.
Pulley system with rope to open
and close the parasol.

TILT & ROTATION

Not applicable.

WIND SPEED

29 km/h, 18 mph - Maximum wind
speed to which the umbrella may
be exposed.

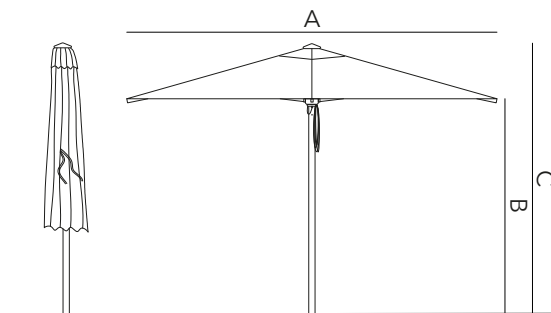

	300 X 300 CM	400 X 400 CM	Ø 350 CM
	22 kg - 48.5 lbs nett excl. base	30 kg - 66.1 lbs nett excl. base	22 kg - 48.5 lbs nett excl. base
A	300 cm - 118.1"	400 cm - 157.5"	350 cm - 137.8"
B	265 cm - 104.3"	265 cm - 104.3"	234 cm - 92.1"
C	300 cm - 118.1"	300 cm - 118.1"	365 cm - 143.7"

CUBA

UFCUB FRAME

	W60 eucalyptus
--	----------------

UCCUB CANOPY BASIC

	C002 white		C105 light grey
--	------------	--	-----------------

UCCUB CANOPY CLASSIC

	C001 natural		C101 cloud
	C106 gris nature		C204 night
	C208 black		C301 taupe

UCCUB CANOPY PREMIUM

	C010 latte		C211 steel
	C304 walnut		C402 tangerine
	C409 brick		C417 jeans
	C424 spinach	Free pick: Other fabrics available upon request.	

UB BASE

	LUC-60-B01 / -B30 lucca heavy
	OPTIONAL UALUC-WHE.60 lucca heavy wheels
	ELB-84-S01 / -S31 elba heavy

IGB-MP-LARGE in ground base

OGB-MP-LARGE on ground base

ACCESSORIES

Protection cover



UBLUC-60
LUCCA HEAVY
CONCRETE

60 kg, 132.3 lbs
59 x 59 x 8 cm
23.2 x 23.2 x 3.1"

B01 white, B30 anthracite
optional: wheels



UBELB-84
ELBA HEAVY
STEEL

84 kg, 185.2 lbs
75.5 x 75.5 x 1.8 cm
29.7 x 29.7 x 0.7"

incl. wheels
S01 white, S31 charcoal

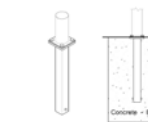

UBIGB-MP-LARGE
IN GROUND BASE

15 kg, 33 lbs
ø 7 x 67 cm, 2.8 x 26.4"
steel



UBOGB-MP-LARGE
ON GROUND BASE

8.4 kg, 18.5 lbs
30 x 30 x 44 cm
11.8 x 11.8 x 17.3"
steel



MOOREA

300 x 300 cm

FRAME

Mid pole umbrella.
Diameter of the pole: \varnothing 55 mm, 2.2".
Scratched teak.
Pulley system with rope to open and close the parasol.

TILT & ROTATION

Not applicable.

WIND SPEED

29 km/h, 18 mph - Maximum wind speed to which the umbrella may be exposed.

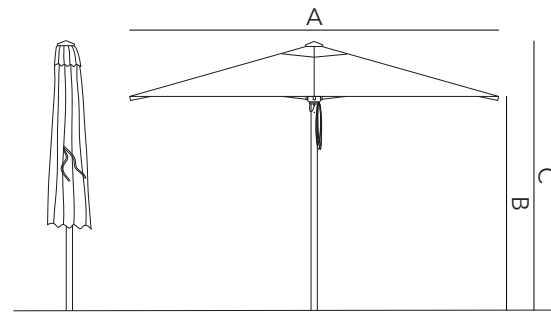

	300 X 300 CM
	28 kg - 61.7 lbs nett excl. base
A	300 cm - 118.1"
B	238 cm - 93.7"
C	272 cm - 107.1"

MOOREA

UFMOO FRAME

W63 teak scratched

UCMOO CANOPY BASIC

C002 white C105 light grey

UCMOO CANOPY CLASSIC

C001 natural	C101 cloud
C106 gris nature	C204 night
C208 black	C301 taupe

UCMOO CANOPY PREMIUM

C010 latte	C211 steel
C304 walnut	C402 tangerine
C409 brick	C417 jeans
C424 spinach	Free pick: Other fabrics available upon request.

UB BASE

	LUC-60-B01 / -B30 lucca heavy
OPTIONAL	UALUC-WHE.60 lucca heavy wheels
	ELB-84-S01 / -S31 elba heavy

IGB-MP-LARGE in ground base

OGB-MP-LARGE on ground base

ACCESSORIES

Protection cover



UBLUC-60
LUCCA HEAVY
CONCRETE

60 kg, 132.3 lbs
59 x 59 x 8 cm
23.2 x 23.2 x 3.1"

B01 white, B30 anthracite
optional: wheels

UBELB-84
ELBA HEAVY
STEEL

84 kg, 185.2 lbs
75.5 x 75.5 x 1.8 cm
29.7 x 29.7 x 0.7"

incl. wheels
S01 white, S31 charcoal

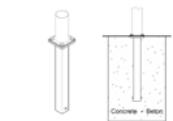

UBIGB-MP-LARGE
IN GROUND BASE

15 kg, 33 lbs
 \varnothing 7 x 67 cm, 2.8 x 26.4"
steel



UBOGB-MP-LARGE
ON GROUND BASE

8.4 kg, 18.5 lbs
30 x 30 x 44 cm
11.8 x 11.8 x 17.3"
steel

UBAZO-125 SILK GREY GRANITE Azore



125 kg, 275.6 lbs
80 x 80 x 5.5 cm, 31.5 x 31.5 x 2.2"

G04
silk grey granite bush hammered

wheels included

UBANT-125 BLACK GRANITE Antego



125 kg, 275.6 lbs
92.5 x 92.5 x 5 cm, 36.4 x 36.4 x 2"

G32
black granite bush hammered

wheels included

UBELB-28 ELBA LIGHT Malibu



28 kg, 63.9 lbs
49 x 49 x 1.6 cm, 19.3 x 19.3 x 0.6"
tube: ø 45 mm, 1.8"

S01 white, **S31** charcoal
metallised & powder coated steel

wheels included

UBLUC-35 LUCCA LIGHT Malibu



35 kg, 77.2 lbs
45 x 45 x 8.5 cm, 17.7 x 17.7 x 3.3"
tube: ø 25 - 44 mm, 1 - 1.7"

quick release system

adaptor rings incl.:
ø 27 mm - 33 mm, ø 1.1" - 1.3"

B01 white, **B30** anthracite
concrete

UALUC-WHE.35
Set 4 wheels
4x ø 50 cm, 19.7"

UBLON-35 LONDON Malibu



35 kg, 77.2 lbs
ø 50 cm, 19.7"
tube: ø 58 mm, 2.3"

B32 black
concrete

wheels included

UBCHI-50 CHICAGO Malibu



50 kg, 110.2 lbs
ø 50 cm, 19.7"
tube: ø 58 mm, 2.3"

B32 black
concrete

wheels included

UBANT-125 SILK GREY GRANITE Antego



125 kg, 275.6 lbs
92.5 x 92.5 x 5 cm, 36.4 x 36.4 x 2"

G04
silk grey granite bush hammered

wheels included

UBANT-125 CONCRETE Antego



125 kg, 275.6 lbs
92.5 x 92.5 x 5 cm, 36.4 x 36.4 x 2"

B03 linen, **B32** black
concrete

wheels included

UBELB-44 ELBA MEDIUM Amalfi



44 kg, 97 lbs
54.5 x 54.5 x 1.8 cm,
21.5 x 21.5 x 0.7"
tube: ø 55 mm, 2.2"
adaptor ring: ø 40 mm, 1.6"

S01 white, **S03** linen, **S31** charcoal
metallised & powder coated steel

wheels included

UBLUC-25 LUCCA HALF Malibu



25 kg, 55.1 lbs
51 x 29 x 8 cm, 20 x 7 x 3.1"
tube: ø 25 - 44 mm, 1 - 1.7"

quick release system

adaptor rings incl.:
ø 27 mm - 33 mm, ø 1.1" - 1.3"

B01 white, **B30** anthracite
concrete

IN GROUND BASES

UBIGB-MP-SMALL Malibu, Amalfi



1 kg, 2.2 lbs
ø 7 x 72 cm, 2.8 x 28"

anodised aluminium

UBIGB-MP-LARGE Cuba, Moorea

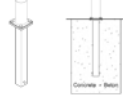

15 kg, 33 lbs
ø 7 x 67 cm, 2.8 x 26.4"

steel

UBIGB-FP-MEDIUM Antego



5.7 kg, 12.6 lbs
ø 21.5 x 51 cm, 8.5 x 20.1"

steel

UBIGB-FP-LARGE Kingston



8.4 kg, 18.5 lbs
ø 25 x 51 cm, 9.8 x 20.1"

steel

ON GROUND BASES

UBOGB-MP-LARGE Cuba, Moorea



8.4 kg, 18.5 lbs
30 x 30 x 44 cm, 11.8 x 11.8 x 17.3"

anodised aluminium

UBFFP-FP-MEDIUM Antego



8 kg, 17.6 lbs
ø 21.5 x 2.1 cm, 8.5 x 0.5"

steel

UBOGB-FP-LARGE Kingston



8 kg, 17.6 lbs
ø 21.5 x 1.2 cm, 8.5 x 0.5"

steel

UBANT-125 SANDSTONE Antego



125 kg, 275.6 lbs
92.5 x 92.5 x 5 cm, 36.4 x 36.4 x 2"

G13
sandstone with sandblasted finish

wheels included

UBANT-125 MARBLE Antego



125 kg, 275.6 lbs
92.5 x 92.5 x 5 cm, 36.4 x 36.4 x 2"

M01 white
marble

wheels included

UBELB-84 ELBA HEAVY Cuba, Moorea



84 kg, 185.2 lbs
75.5 x 75.5 x 1.8 cm
29.7 x 29.7 x 0.7"
tube: ø 65 mm, 2.6"

S01 white
S31 charcoal
metallised & powder coated steel

wheels included

UBLUC-60 LUCCA HEAVY Cuba, Moorea



60 kg, 132.3 lbs
59 x 59 x 8 cm, 23.2 x 23.2 x 3.1"
tube: ø 25 - 55 mm, 1 - 2.2"

adaptor rings incl.:
ø 27 mm - 33 mm - 45 mm
ø 1.1" - 1.3" - 1.8"

B01 white, **B30** anthracite
concrete

UALUC-WHE.60
Set 4 wheels
4x ø 50 cm, 19.7"



UBKIN-300 KINGSTON Kingston









300 kg, 661.4 lbs
100 x 100 x 10 cm, 39.4 x 39.4 x 4"
tube: ø 45 mm, 1.7"

G04
silk grey granite bush hammered





wheels included

ARCQ		NEW	
	DELIGARC.S Small ø 39 x 48.5 cm, 15 x 19"		F18 straw
	DELIGARC.L Large ø 48 x 60 cm, 19 x 24"		F18 straw











synthetic material with solar-powered lamp

ANTIBES			
	DECANDANT.S Small 21 x 21 x 41,5 cm 8 x 8 x 16"		W62 teak
	DECANDANT.M Medium 30 x 30 x 52 cm 12 x 12 x 20"		W62 teak
	DECANDANT.L Large 32 x 32 x 81 cm 13 x 13 x 32"		W62 teak
	DEDECANTTUB.01 Winetub ø 47 x 24 cm, 19 x 9"		W62 teak
	DEDECANTCOOL.01 Winecooler ø 27 x 30 cm, 11 x 12"		W62 teak

teak with stainless steel parts

INTEGRA			
	DECANINT.S Small ø 30 x 35,5 cm, 12 x 14"		S99 black & gold
	DECANINT.M Medium ø 35,5 x 40,5 cm, 14 x 16"		S99 black & gold
	DECANINT.L Large ø 47 x 55,5 cm, 19 x 22"		S99 black & gold

steel





SOLORE			
	DELIGSOL.CS Cube small 25 x 25 cm, 10 x 10"		F15 natural
	DELIGSOL.CM Cube medium 33,5 x 33,5 cm, 13 x 13"		F17 taupe
			F15 natural
	DELIGSOL.CL Cube large 43 x 43 cm, 17 x 17"		F17 taupe
			F15 natural
		DELIGSOL.SS Sphere small ø 30 x 24,5 cm, 12 x 10"	
DELIGSOL.SM Sphere medium ø 38,5 x 33,5 cm, 15 x 13"			F17 taupe
			F15 natural
DELIGSOL.SL Sphere large ø 47,5 x 43 cm, 19 x 17"			F17 taupe
			F15 natural

aluminium frame, enclosed in HDPE fiber



Solar LED light providing warm outdoor light. Rechargeable battery with solar energy or USB. Can be put on the floor or be hung. Supplied with outdoor rope & USB cable. Operate the light with the application "SLS Control". Available on the App Store and Google Play. The Solore Solar Module is included.

TERRA		UPDATED	
	DEPOTTERB-SET1 Balloon 91 high Balloon 112 high		P03 sabbia
			P11 macchiato
			P32 nero
DEPOTTERB91.H Balloon 91 high - ø 91 x 56 cm, 36 x 22"			
DEPOTTERB112.H Balloon 112 high - ø 112 x 67 cm, 44 x 26"			
	DEPOTTERB55.L Balloon 55 low ø 55 x 35 cm, 22 x 14"		P03 sabbia
			P11 macchiato
			P32 nero
	DEPOTTERB55.M Balloon 55 mid ø 55 x 45 cm, 22 x 18"		P03 sabbia
			P11 macchiato
			P32 nero
	DEPOTTERB55.H Balloon 55 high ø 55 x 56 cm, 22 x 22"		P03 sabbia
			P11 macchiato
			P32 nero
	DEPOTERR45.M 45 mid ø 45 x 112 cm, 18 x 44"		P03 sabbia
			P11 macchiato
			P32 nero
DEPOTERR55.H 55 high ø 55 x 137 cm, 22 x 54"		P03 sabbia	
		P11 macchiato	
		P32 nero	



FPR combined with natural materials

CUMINO				
	DEPOTCUM-SET1 52 low - 68 mid - 88 high		P18 ruggine	
			DEPOTCUM52.L 52 low - ø 52 x 60 cm, 20 x 24"	
			DEPOTCUM68.M 68 mid - ø 68 x 80 cm, 27 x 31"	
			DEPOTCUM88.H 88 high - ø 88 x 102 cm, 35 x 40"	
	DEPOTCUM144.L 144 low ø 144 x 54 cm, 56.7 x 21"		P01 panna	

FPR combined with natural materials

CURVO		NEW		
	DEPOTCUR-SET1 32 low - 45 mid - 55 high		P30 caffè	
			DEPOTCUR32.L 32 low - ø 32 x 60 cm, 13 x 24"	
			DEPOTCUR45.M 45 mid - ø 45 x 80 cm, 18 x 31"	
			DEPOTCUR55.H 55 high - ø 55 x 90 cm, 22 x 35"	

FPR combined with natural materials

CARTELLO		NEW	
	DEPOTCAR75.L 75 low ø 75 x 35 cm, 30 x 14"		P31 marone
			DEPOTCAR75.H 75 high ø 75 x 68 cm, 30 x 27"

FPR combined with natural materials

RUGS

LONGI

	DERUGLON200X300 200 x 300 cm, 79 x 118"		D80 long hair ecru
	DERUGLON250X350 250 x 350 cm, 98 x 138"		D80 long hair ecru
			D81 long hair grey
	DERUGLON300X400 300 x 400 cm, 118 x 157"		D80 long hair ecru
DERUGLON300XR ø 300 cm, 118"		D80 long hair ecru	
		D81 long hair grey	









hand woven polyolefin

JUTE

	DERUGJUT200X300 200 x 300 cm, 79 x 118"		D82 jute
	DERUGJUT300X400 300 x 400 cm, 118 x 157"		D82 jute

hand braided polyolefin rope

VASCO

	DERUGVAS170X240 170 x 240 cm, 67 x 95"		D84 charcoal
			D85 aqua
	DERUGVAS200X300 200 x 300 cm, 79 x 118"		D84 charcoal
			D85 aqua
	DERUGVAS250X350 250 x 350 cm, 98 x 138"		D84 charcoal
			D85 aqua
DERUGVAS250X250 250 x 250 cm, 98 x 98"		D84 charcoal	
		D85 aqua	

100% hand woven recycled PET





HAMPTON

	DERUGHAM200X300 200 x 300 cm, 79 x 118"		D90 ivory
			D91 taupe
			D92 grey
	DERUGHAM250X350 250 x 350 cm, 98 x 138"		D91 taupe
			D92 grey
			D90 ivory
	DERUGHAM300X400 300 x 400 cm, 118 x 157"		D91 taupe
			D92 grey
			D90 ivory

PET 80%, polyester 20%, hand woven

WILSON



NEW

	DERUGWIL200X300 200 x 300 cm, 79 x 118"		D77 shell
			D78 oyster
			D79 greige
	DERUGWIL250X350 250 x 350 cm, 98 x 138"		D77 shell
			D78 oyster
			D79 greige
	DERUGWIL280X390 280 x 390 cm, 110 x 154"		D77 shell
			D78 oyster
			D79 greige

polyester and high-quality Decolan yarn



POUFS

JUTE

	DEPOUJUT.RS Small ø 50 x 40 cm, 19 x 16"		D82 jute
	DEPOUJUT.RL Large ø 75 x 35 cm, 30 x 14"		D82 jute





hand braided polyolefin rope

DONUT

	DEPOUDON.RS Small ø 55 x 26 cm, 22 x 10"		F14 bohemian
	DEPOUDON.RL Large ø 110 x 36 cm, 43 x 14"		F14 bohemian









hand woven wicker viro fiber

LONGI

	DEPOULON.RS Small ø 50 x 40 cm, 19 x 16"		D80 long hair ecru
			D81 long hair grey
	DEPOULON.RL Large ø 100 x 40 cm, 39 x 16"		D80 long hair ecru
			D81 long hair grey

hand woven polyolefin

HAMPTON

	DEPOUHAM.SS Small 50 x 50 x 40 cm 19 x 19 x 16"		D93 oat
			D94 metal
			D95 mustard
	DEPOUHAM.SL Large 100 x 100 x 40 cm 39 x 39 x 16"		D93 oat
			D94 metal
			D95 mustard
			D96 indigo

PET 80%, polyester 20%, hand woven

BAY

	DEPOUBAY.RS Small ø 50 x 40 cm, 19 x 16"	Cat. A, B & C
		Free pick Other fabrics available upon request.
	DEPOUBAY.RM Medium ø 50 x 50 cm, 19 x 19"	Cat. A, B & C
		Free pick Other fabrics available upon request.
	DEPOUBAY.RL Large ø 80 x 40 cm, 32 x 16"	Cat. A, B & C
		Free pick Other fabrics available upon request.

100% solution dyed acrylic



Material SPECIFICATIONS

Our materials are always selected in function of intensive outdoor use and exposure to the sun. Jardinico only works with the best materials to ensure the best quality, added value and a luxurious appearance in any environment around the globe. Quality, aesthetics and durability are absolute top priorities. The best materials embrace all beautiful designs for you to enjoy the outdoors carefree for many years to come.

MATERIALS

All fabrics for the outdoor umbrella canopies from the Attitude collection are 100% recyclable and high performance fabrics. They are manufactured from solution dyed acrylic or olefin yarns and are ideal for protection from the bright sun rays, wind and rain. The fabrics have been treated with a PU coating, which makes them stain and water repellent.

Performance

The canopies are made of solutions dyed acrylic or olefin. This means the colour of the fabric runs all the way through the yarn. The colour is added to the liquid solution that the yarn is extruded from. Only solution dyed fabrics keep their colour and are resistant to fading under the effect of UV rays when exposed to the sun.

Stain resistant & waterproof

All fabrics have a surface finish that makes the fabric water and stain repellent. A coating on the reverse side makes the fabric waterproof, mildew resistant and keeps its drying time to a minimum. Please consult our product data sheets or website to learn more on how to care and maintain your fabrics.

Premium fabrics	Solution dyed acrylic
Classic fabrics	Solution dyed acrylic
Basic fabrics	Solution dyed olefin

Fast stock

Canopies available from stock. We offer 'fast stock' to speed up the delivery time of our canopies. We selected a few fabrics of which canopies are held in stock in Belgium and can be delivered quickly. This service is subject to availability of raw materials worldwide. These colours are shown below with the following icon:

It is always possible to order canopies that differ from the fast stock colours. A delivery time of six to eight weeks should be taken into account. An overview of all available fabrics can be found below.

PREMIUM FABRICS

C010 latte Antego, Amalfi	C211 steel Antego, Amalfi	C304 walnut Antego, Amalfi	C402 tangerine	C409 brick	C417 jeans	C424 spinach

CLASSIC FABRICS

C001 natural Antego, Kingston, Amalfi	C101 cloud Antego, Kingston, Amalfi	C106 gris nature Antego, Kingston, Amalfi	C204 night Antego, Kingston, Amalfi	C208 black Antego, Kingston, Amalfi	C301 taupe Antego, Kingston, Amalfi

BASIC FABRICS

C002 white Cuba, Moorea	C105 light grey Cuba, Moorea	C109 speckle	C200 dark grey	C209 coal	C302 mocca
C405 orange	C407 red	C418 ocean	C421 kiwi		

MATERIALS

MATERIALS

ALUMINIUM

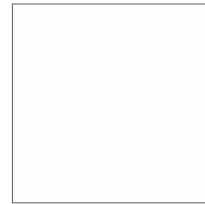

A01
white



A02
silver



A03
linen



A11
taupe

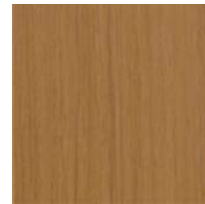

A12
alu teak

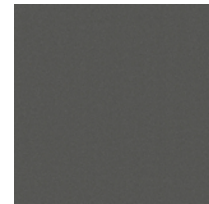

A30
anthracite



A32
black

WOOD

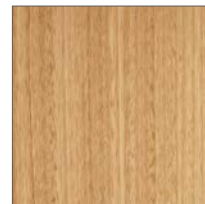

W60
eucalyptus

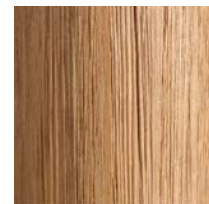

W63
teak scratched

Aluminium treated with a structured coloured coating.

Epoxy powder coating to increase durability and strength. It makes the material water repellent, stain and scratch resistant.

Excellent resistance to corrosion under the effect of various weather conditions due to the technique also used in marine applications.

Suitable for outdoor use. Easy to clean and maintain.

Superior quality eucalyptus and scratched teak hardwood, harvested from ecological, tropical plantations.

Great stability under the effect of various weather conditions. Ages gracefully and turns its colour into a magnificent light silver.

Suitable for outdoor use. Easy to clean and maintain. Various treatments are applicable, according to your preference.



LUNA LED LIGHT

LUNA LED LIGHT

During summer, we prefer to spend most of our time outdoors. When the sun goes down, it's time to attach our Luna LED light to your parasol. You'll create a warm glow by adding this light to the built-in holder on the frame.

Luna LED light is wireless with 16 LEDs and a BT speaker. The light has a warm white colour and plays your music continuously for six to ten hours.

Colour: grey

Light: warm LED light

Fits on: Azore p. 94
Antego p. 96
Kingston p. 98
Amalfi p. 100
Malibu p. 102





Protection & MAINTENANCE

To enhance the durability and appearance of your outdoor umbrella, we recommend following our care instructions regularly. The umbrella should never be used in strong wind or rainy conditions. An open umbrella should never be left unattended. The umbrella should be protected against blurring or damage by always using its accompanying protection cover. During autumn and winter, we advise to store the umbrella in a dry place when not in use.

PROTECTION

PROTECTION COVER

We suggest to always use the protection cover to protect your outdoor umbrella from poor weather conditions or when not in use during the summer. The protection cover can be placed over the umbrella and its pole. The stain resistant and water repellent cover will extend its life for you to enjoy your umbrella whenever you like.

Ref.	Colour	Swatch	About this fabric
X75	Grey		100% solution dyed polyester with PU coating



MAINTENANCE

FRAME & BASE

Clean the aluminium frame with a damp cloth, mild soap and water. Do not use any sharp tool to avoid scratches.







CANOPY

Before use, you can apply an invisible film to make the canopy stain and water repellent by using a textile protector. You can maintain and clean them by following a few simple steps:

- Brush off loose dirt before it becomes embedded in the fabric.
- Hose down.
- Spot clean soon after stains occur with water and mild soap or textile cleaner (no detergents). Use a soft bristle brush to clean.
- Allow soap to soak in.
- Rinse thoroughly.
- Always let cushions air dry completely before storing or covering.

Machine wash in cold water. Depending on wash load size, use normal amounts of mild laundry detergent and add 1 cup of bleach. Allow fabric to air dry. Never subject to excessive heat, steam press or tumble dry as the fabric will shrink.

CORRECTOR PEN 12 ML

	SPCOR-12ML	 A01 white
		 A03 linen
		 A11 taupe
		 A30 anthracite
		 A31 charcoal
		 A32 black

Quick-drying liquid paint with built-in brush for powder-coated surfaces. Ideal for retouching small surface traces (scratches, wear).

MAINTENANCE SET TEXTILE

	SPCARE-TEXT-75CL	2 scrubbing pads 3 application cloths 1 textile protector 750 ml 1 textile cleaner 750 ml
-------------------------------------------------------------------------------------	-------------------------	----------------------------------------------------------------------------------------------------

MAINTENANCE SET STONE

	SPCARE-STONE-50CL	1 scrubbing pad 1 application cloth 1 natural stone protector 500 ml 1 natural stone cleaner 500 ml
---------------------------------------------------------------------------------------	--------------------------	--------------------------------------------------------------------------------------------------------------



Project REFERENCES

Fairmont Royal palm - Marrakesh - Morocco

Sea lounge - Porto-Vecchio - Corsica

Cove beach - Dubai - UAE

Limonade Maillot - Paris - France

Kempinski - Aqaba - Jordan

Jules Bar - Kortrijk - Belgium

Radisson Blu - Wiesbaden - Germany

Limonade Maillot - Paris - France

Wittamer - Brussels - Belgium

Kempinski Hotel - Bruges - Belgium

Blue Origin - Deerlijk - Belgium

Blue Buddha Beachclub - Knokke - Belgium

Collin's Beach - Knokke - Belgium

Bar d'O Beach Club - Knokke - Belgium

Blue Buddha beach club - Knokke - Belgium

Kruisheren Hotel - Maastricht - The Netherlands

Country Club - Samois Sur Seine - France

Le Couvent des Minimes - Mane - France

Hôtel Julien - Fouday - France

Peninsula - Paris - France

Golf Up - Grimaud - France

Nørgaard - Hornbaek - Denmark

La Plage - Casadelmar - Corsica

Yacht Club - Porto-Montenegro

La Gazelle d'Or - Tunesia

Parkhotel - Kortrijk - Belgium

Eyebar - Hong Kong - China

Honi Honi Bar - Hong Kong - China

Wooloo Mooloo - Hong Kong - China

Retreat & Spa - Maledives

Berjaya Hotel - Kuala Lumpur - Malaysia

Mulia Hotel - Bali - Indonesia

Age-Hassim Hill - Singapore

Joe's Café - Doha - Qatar

Utopia - Abu Dhabi

Mercure Hotel Harbourside - Carens - Australia

Royalton Hotel Riviera Cancun - Mexico

Grand Palladium Lady Hamilton - Jamaica

Radisson Blu - Dakar - Senegal

Catalogue made thanks to:

- Jardinico® team
- Shoot Photography
- Steije.be Creative Video Agency
- Frederik Naessens Transport

JARDINICO PARASOLS BV
Evolis 101
8530 Harelbeke
Belgium

T +32 (0)56 89 04 10

info@jardinico.com
www.jardinico.com

Follow us on:



Visit our website
to learn more:



www.jardinico.com