

# DEDON



Lounging Dining Iconics Lighting

Product Details 2021/2022

DEDON



# TERMS & CONDITIONS

## TERMS AND CONDITIONS

### AREAS OF USAGE

Certain products are recommended for use exclusively in the residential sector. For use in public areas such as public educational institutions, restaurants or meeting places, where the furniture may be exposed to particularly high stress, special requirements and standards apply. Please always ask about the suitability of your desired DEDON products for public places before placing an order. All products intended for contract use are marked with a contract icon.



### PRICES

Please note that, from 2022 onwards, our price list includes recommended retail prices including VAT. Our partners' individual purchase prices are based on the recommended price list and are linked to the terms of the valid partner agreement concluded between DEDON and the individual partner. Please contact your DEDON sales representative for any further price information. DEDON reserves the right to adjust the recommended retail prices with a notice period of 4 weeks. The adjustment shall be made if the costs for production (raw materials and/or personnel) and/or transport costs increase or decrease by more than 5% during the term of the contract. Upon expiry of the notice period, the new non-binding price recommendations shall apply as the calculation basis for the price calculations resulting from the partner contracts. The new recommended retail prices will be handed out in printed form as a supplement to the current price List.

RRP =  
**2.600 €**  
RRP incl. VAT

### DISCLAIMER

Although the information in this price list is presented in good faith and believed to be correct at the time of printing, DEDON makes no representations or warranties as to the completeness or accuracy of the information. DEDON accepts no liability for any errors or omissions. DEDON reserves the right to change specifications and descriptions in light of technical developments and the availability of materials.

We are not liable for variations in color, weight or dimensions, since such variations are typical of handmade furniture. Some items and fabrics that are featured in mood images may be discontinued.

### WEIGHT

The stated weight of a furniture item does not include cushions and may vary according to fiber options.

### CUSTOMER OWN MATERIAL (COM) CUSHIONS

Some customers prefer their own fabrics for DEDON cushions and upholstery therefore we have added the COM demand for every cushion within this pricelist as listed below. The COM fabric requirement is calculated for a plain fabric without a pattern repeat with a width of 1,53 yds. If you have any questions about cushions that we might produce from your own fabrics, please feel free to contact our customer service.

Please note:

- Prices for COM production are calculated on a category B level.
- We do not provide any warranty for cushions made of COM.
- We cannot accept direct fabric deliveries from you or your client.

SEAT CUSHION  
Sitzkissen  
**COM 0,63 M**  
  
95027001

## ALLGEMEINE GESCHÄFTSBEDINGUNGEN

### EINSATZBEREICHE

Einige Produkte sind nur für den privaten Wohnbereich gedacht. Für den Einsatz in öffentlichen Bereichen, z.B. in Bildungseinrichtungen, Restaurants oder an Versammlungsorten, wo die Möbel besonders stark belastet werden, gelten bestimmte Anforderungen und Standards. Erkundigen Sie sich daher bitte vor jeder Bestellung, ob die DEDON Produkte Ihrer Wahl für die Verwendung an öffentlichen Orten geeignet sind. Alle Produkte, die für eine gewerbliche Nutzung gedacht sind, sind mit dem Symbol "C" (Contract) gekennzeichnet.



### PREISE

Bitte beachten Sie, dass wir ab 2022 in unseren Preislisten unverbindliche Preisempfehlungen mit MwSt. angeben. Die individuellen Einkaufspreise unserer Partner basieren auf der Liste der unverbindlichen Preisempfehlungen und Bedingungen des jeweils geltenden Partnervertrags zwischen DEDON und dem Partnerunternehmen. Bitte wenden Sie sich für weitere Informationen hinsichtlich der Preise an Ihren zuständigen DEDON-Ansprechpartner. DEDON behält sich vor, einmal jährlich die unverbindlichen Preisempfehlungen mit einer Ankündigungsfrist von 4 Wochen anzupassen. Die Anpassung erfolgt, wenn sich die Kosten für die Produktion (Rohmaterial und / oder Personal) und/oder die Transportkosten während der Vertragslaufzeit um mehr als 5 % erhöhen bzw. verringern. Mit Ablauf der Ankündigungsfrist gelten die neuen unverbindlichen Preisempfehlungen als Kalkulationsgrundlage für die sich aus den Partnerverträgen ergebenden Preisberechnungen. Die neuen UVP werden in ausgedruckter Form als Ergänzung zur jeweils aktuellen Preisliste ausgehändigt.

UVP =  
**2.600 €**  
UVP inkl. MwSt.

### HAFTUNGSAUSSCHLUSS

Die Angaben in der Preisliste wurden nach bestem Wissen erstellt. Wir gehen davon aus, dass sie zum Druckzeitpunkt korrekt sind. Dennoch macht DEDON keine Zusicherungen und übernimmt keine Garantie für ihre Vollständigkeit und Richtigkeit. DEDON haftet nicht für Fehler oder fehlende Angaben. DEDON behält sich das Recht vor, Eigenschaften und Beschreibungen aufgrund technischer Entwicklungen bzw. der Verfügbarkeit von Materialien zu ändern.

Für Farben, Maße und Gewichte können wir keine Haftung übernehmen, da Abweichungen bedingt durch Handarbeit möglich sind. Manche Produkte und Stoffe, die in unseren Abbildungen zu sehen sind, sind ggf. nicht mehr verfügbar.

### GEWICHT

Die Angaben zu dem Gewicht eines Möbelstücks verstehen sich exklusive Kissen und können aufgrund von unterschiedlichen Faserausführungen leicht variieren.

### KISSEN AUS KUNDENEIGENEM STOFF (COM)

Einige Kunden bevorzugen eigenen Stoff für die Anfertigung von DEDON Kissen und Polsterauflagen, deshalb werden diese Information bei jedem Kissen wie unten abgebildet zusätzlich angegeben. Der COM Stoffbedarf ist für einen unifarbene Stoff ohne Rapport mit einer Breite von 140 cm kalkuliert. Bei Fragen zu Kissen, die wir aus Ihren eigenen Stoffen fertigen dürfen, wenden Sie sich gerne an unseren Kundenservice.

Bitte beachten Sie:

- Preisbasis für die Kissen aus kundeneigenem Stoff ist die Kategorie B.
- Wir übernehmen keinerlei Garantie für Kissen aus kundeneigenem Stoff.
- Wir akzeptieren keinerlei Zusendung von Stoffen.

SEAT CUSHION  
Sitzkissen  
**COM 0,63 M**  
  
95027001

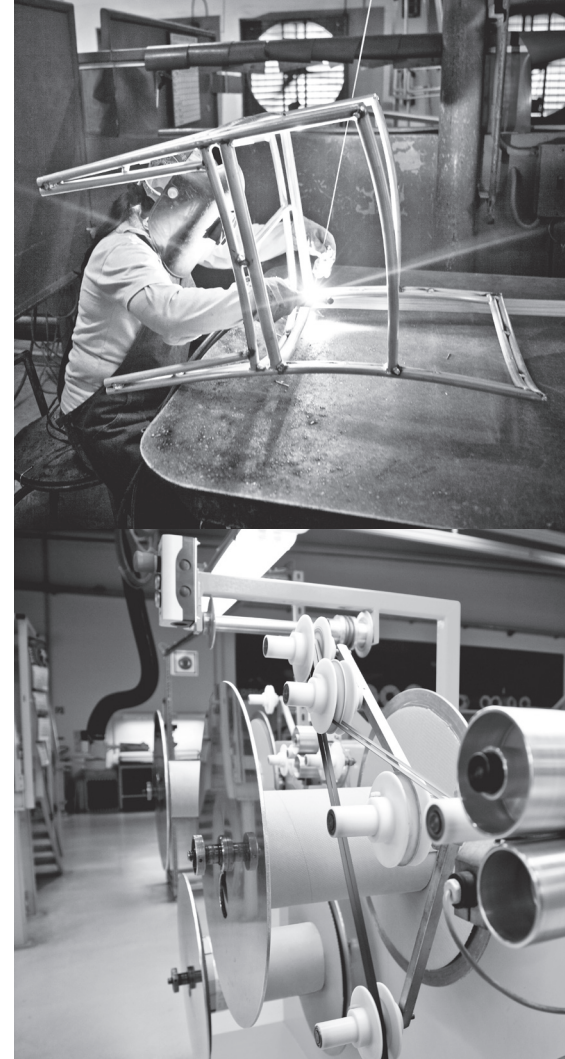



# CONTENTS

## DINING CHAIRS



AIIR  
page 17



AIIR  
page 17



MBRACE  
page 77



PANAMA  
page 104



PANAMA  
page 104



ROII  
page 123



ROII  
page 123



SEASHELL  
page 138



SEASHELL  
page 139



SEAX  
page 143



TANGO  
page 161



TIBBO  
page 167



SEASHELL  
page 139



PANAMA  
page 105

## LOUNGE CHAIRS



AHNDA  
page 13



AHNDA  
page 13



BRIXX  
page 31



DALA  
page 39



DALA  
page 39



KIDA  
page 51



LOUNGE  
page 59



MBRACE  
page 75



MBRACE  
page 75



MBRACE  
page 75



MBRACE  
page 75



MBRACE ALU  
page 81



MBRACE ALU  
page 81



MBRACE ALU  
page 81



MU  
page 89



PANAMA  
page 105



RILLY  
page 119



ROII  
page 123



SEASHELL  
page 139



SEAX  
page 144



SWINGREST  
page 156



TANGO  
page 161



TANGO  
page 162



TIBBO  
page 167



TIBBO  
page 167

# CONTENTS

## LOUNGING



AHNDA  
page 13



BRIXX  
page 31



DALA  
page 40



KIDA  
page 51



LOUNGE  
page 59



MBARQ  
page 67



MBRACE  
page 75



MU  
page 89



NESTREST  
page 97



ORBIT  
page 101



PAROS  
page 109



RILLY  
page 119



SEALINE  
page 131



SEASHELL  
page 139



SWINGREST  
page 157



SWINGREST  
page 155



TANGO  
page 161



TIBBO  
page 167



# CONTENTS

## TABLES



## SIDE / COFFEE TABLES



## BEACH CHAIRS



# CONTENTS



## ACCESSORIES



## ICONICS



## LIGHTING







# AHNDA

Design by STEPHEN BURKS



Wing chair, graphite | Cushion: TWIST sand, TWIST gray





# AHNDA

Design by STEPHEN BURKS

## Typology

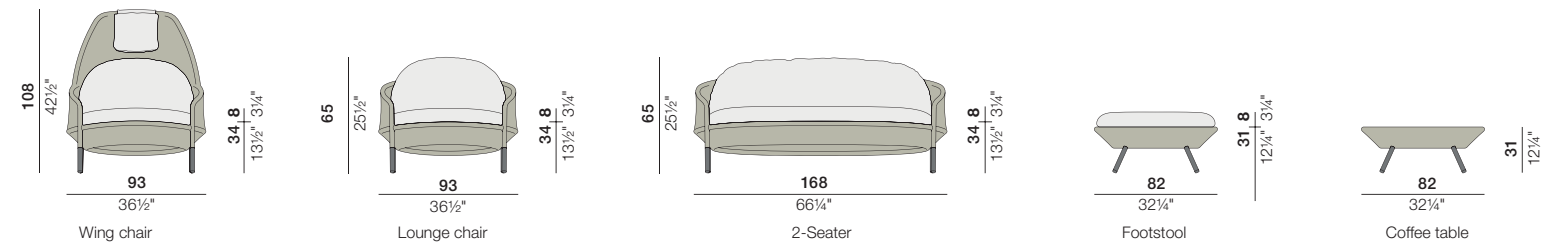

## Materials

### Combinations

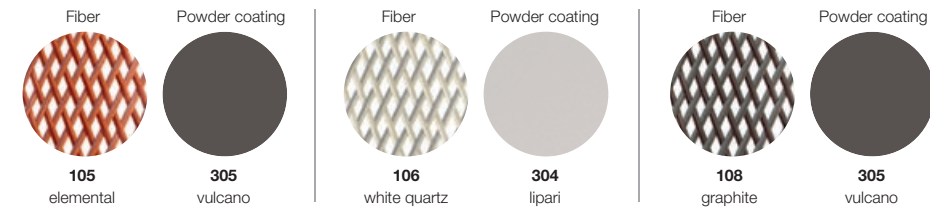

### Tabletop glass

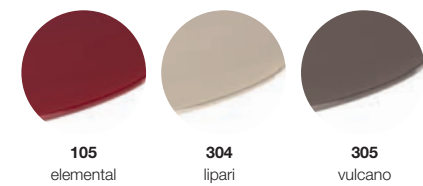

## Fabric Information (see page 224)

Cushions for this collection are available in all fabrics Cat. A, B, C.  
Kissen für diese Kollektion sind in allen Stoffen der Kat. A, B, C verfügbar.

### RRP/UDP

#### WING CHAIR Hochlehner

18 kg  
40 lbs



DRY+ SEAT CUSHION  
Dry+ Sitzkissen  
COM 1,25 M

DRY+ BACK CUSHION  
Dry+ Rückenkissen  
COM 1,10 M



070006

070006108

95070207

95070208

5607006000

#### LOUNGE CHAIR Sessel

12 kg  
27 lbs



DRY+ SEAT CUSHION  
Dry+ Sitzkissen  
COM 1,25 M

DRY+ BACK CUSHION  
Dry+ Rückenkissen  
COM 1,10 M



070005

070005108

95070207

95070208

5607005000

#### 2-SEATER 2er-Sofa

15 kg  
34 lbs



DRY+ SEAT CUSHION  
Dry+ Sitzkissen  
COM 2,20 M

DRY+ BACK CUSHION  
Dry+ Rückenkissen  
COM 1,80 M



070012

070012108

95070212

95070213

56070012000

#### FOOTSTOOL Hocker

6 kg  
14 lbs



DRY+ SEAT CUSHION  
Dry+ Sitzkissen  
COM 1,25 M

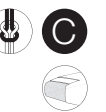

070031

070031108

95070231

56070031000

#### COFFEE TABLE Kaffeetisch

15,5 kg  
35 lbs



Set: 070032108



070032

Set: 070032108

56070031000

#### DRY+ HEADREST CUSHION Dry+ Nackenkissen



95070206

95070209

95070209

COM 0,60 M



### EN MATERIAL

AHNDA furniture consist of DEDON fiber woven over a powder coated aluminum frame. To clean the surface, use a soft cloth or brush, warm water and a gentle cleanser if needed.

### DE MATERIAL

Die Möbel der AHNDA-Kollektion bestehen aus DEDON-Faser, die auf einen pulverbeschichteten Aluminiumrahmen geflochten ist. Um die Oberfläche zu reinigen, benutzen Sie ein weiches Tuch oder eine weiche Bürste, warmes Wasser und, falls nötig, ein sanftes Reinigungsmittel.





# AIIR

Design by GAMFRATESI



Armchair, pepper

# AIIR

Design by GAMFRATESI

## Typology

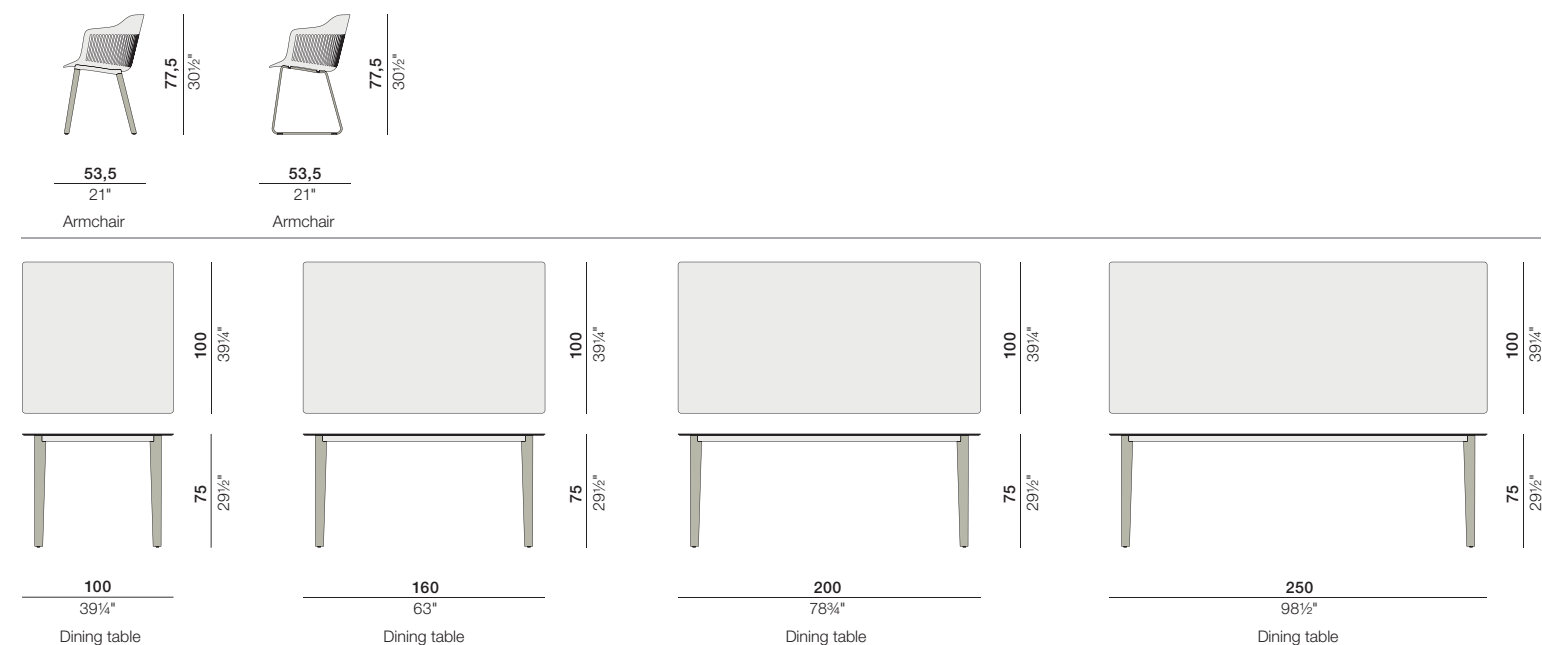

## Materials

### Seat

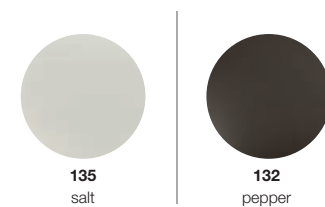

### Chair base options



## Fabric Information (see page 224)

Items of this collection are available in all fabrics Cat. A, B & Cat. C (only Kvadrat® Atrium).  
 Artikel dieser Kollektion sind in den Stoffen der Kat. A, B & Kat. C (nur Kvadrat® Atrium) verfügbar.

RRP/UDP

ARMCHAIR  
 Armlehnstuhl

6 kg  
 14 lbs

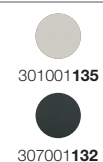

SEAT CUSHION  
 Sitzkissen  
 COM 0,59 M

OPTIONAL BACK CUSHION  
 Optionales Rückenkissen  
 COM 0,47 M



95300001 95103002 56300001000

ARMCHAIR  
 Armlehnstuhl

6,4 kg  
 15 lbs



SEAT CUSHION  
 Sitzkissen  
 COM 0,59 M

OPTIONAL BACK CUSHION  
 Optionales Rückenkissen  
 COM 0,47 M



95300001 95103002 56300001000

### EN MATERIAL

The seats of the AIIR armchairs consist of injection molded polypropylene. To clean the surface, use a soft cloth, warm water and a gentle cleanser, if needed. The bases are made of premium teak or powder coated stainless steel. Clean the powder coating with a soft cloth and warm water. Clean teak with DEDON Teak Cleaner. To retain the golden-brown color of unweathered teak, we recommend applying DEDON teak oil at least once every six months. We recommend a regular cleaning of the base to prevent stains.

### DE MATERIAL

Die Sitzschalen der AIIR-Kollektion werden im Spritzgussverfahren aus Polypropylen hergestellt. Zur Reinigung eignen sich ein weiches Tuch, warmes Wasser und bei Bedarf ein sanftes Reinigungsmittel. Die Untergestelle bestehen aus Premium-Teak oder pulverbeschichtetem Edelstahl. Die Pulverbeschichtung einfach mit einem weichen Tuch und warmem Wasser reinigen. Reinigen Sie das Teakholz mit DEDON Teak Reiniger. Um den ursprünglichen, goldbraunen Farbton des Teakholzes zu bewahren, tragen Sie mindestens alle sechs Monate das DEDON Teak-Öl auf. Wir empfehlen eine regelmäßige Reinigung des Untergestells, um Fleckenbildung zu vermeiden.



RRP/UVF

DINING TABLE  
Esstisch

100 × 100 cm  
26,8 kg  
39¼" × 39¼"

60 lbs

- Set: 303079**306**
- Set: 303079**317**
- Set: 303079**001**

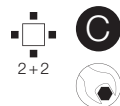
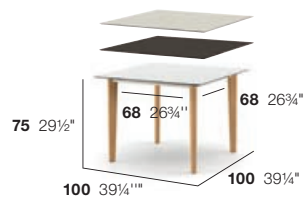

56300081000

DINING TABLE  
Esstisch

100 × 160 cm  
36,5 kg  
39¼" × 63"

81 lbs

- Set: 303071**306**
- Set: 303071**317**
- Set: 303071**001**

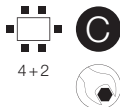
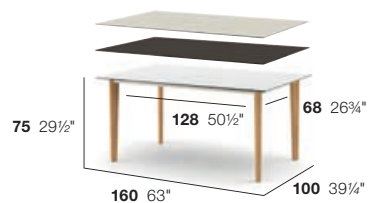

56300069000

DINING TABLE  
Esstisch

100 × 200 cm  
45,8 kg  
39¼" × 78¾"

101 lbs

- Set: 303072**306**
- Set: 303072**317**
- Set: 303072**001**

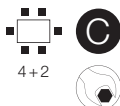
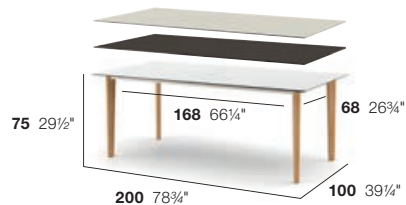

56300073000

DINING TABLE  
Esstisch

100 × 250 cm  
58,2 kg  
39¼" × 98½"

129 lbs

- Set: 303064**306**
- Set: 303064**317**
- Set: 303064**001**

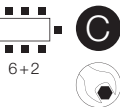
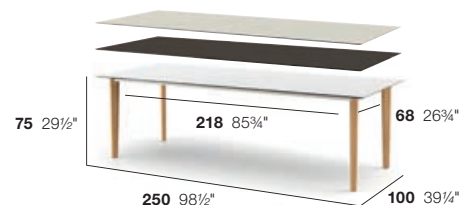

56300065000

### Tabletop HPL



306  
lipari 2.0

317  
black pepper

001  
white

**EN MATERIAL**  
AIIR dining tables come with teak legs and HPL tabletops. Wash using DEDON teak cleaner. To retain the golden-brown color of unweathered teak, we recommend applying DEDON teak oil at least once in every six months. To clean the HPL-tabletops, use a soft cloth, warm water and a gentle cleanser if needed.

**DE MATERIAL**  
Die Beine der AIIR-Esstische sind aus Premium-Teak gefertigt, die Tischplatten bestehen aus HPL. Reinigen Sie das Teakholz mit DEDON Teak Reiniger. Um den ursprünglichen, goldbraunen Farbton zu bewahren, tragen Sie mindestens alle sechs Monate das DEDON Teak Öl auf. Zur Reinigung der HPL-Tischplatten eignen sich ein weiches Tuch, warmes Wasser und bei Bedarf ein sanftes Reinigungsmittel.



# AIIR DINING

Design by GAMFRATESI



AIIR Setting 01

- 6x 00301001135 AIIR Armchair, salt
- 6x 95300001664 AIIR Seat cushion, TWIST dark turquoise
- 1x 00303064306 AIIR Dining table 100 x 250 cm, lipari
- 1x 00098025125 VID Carpet solid 300 x 400 cm, canvas
- 1x 00073061168 DALA Lantern M, bahamas
- 2x 00073060168 DALA Lantern S, bahamas



AIIR Setting 02

- 4x 00307001132 AIIR Armchair, pepper
- 4x 95300001662 AIIR Seat cushion, TWIST gray
- 1x 00303072317 AIIR Dining table 100 x 200 cm, black pepper



AIIR Setting 03

- 6x 00307002132 AIIR Armchair with sled base, pepper
- 6x 95300001660 AIIR Seat cushion, TWIST beige
- 2x 00050140317 SATELLITE Dining table Ø 70 cm, black pepper



AIIR Setting 04

- 8x 00301001135 AIIR Armchair salt
- 8x 95300001478 AIIR Seat cushion, NATURA ash
- 1x 00085055205 MBRACE Dining table 270 x 90 cm, teak



# BABYLON STOOL / SIDE TABLE

Design by HARRY-PAUL



Stool / Side table ceramic

## Typology

cm inch

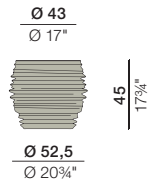

Stool/Side table

RRP/UVP

STOOL / SIDE TABLE CERAMIC  
Hocker / Beistelltisch Keramik

Ø 52,5 cm  
17 kg  
Ø 20 3/4"  
38 lbs



Ø 52,5 Ø 20 3/4"

053089308

053089

STOOL / SIDE TABLE PE  
Hocker / Beistelltisch PE

Ø 52,5 cm  
5 kg  
Ø 20 3/4"  
12 lbs



Ø 52,5 Ø 20 3/4"

05311000

### EN MATERIAL

Made of Monolite Ipergres®: Frost proof, non-absorbing ceramic material with excellent resistance to scratches, abrasion and indirect tensile stress. Due to method of production, the side table does not have an entirely level surface. Ceramic tabletops are handmade. This may cause variations that make each piece truly unique.

Clean with a soft cloth and warm water. Do not cover in winter months and ensure sufficient air circulation. BABYLON PE consists of rotomolded polyethylene: easy to maintain, 100% recyclable, light yet robust at the same time. To clean the surface, use a soft cloth, warm water and a gentle cleanser, if needed.

## Materials

Ceramic

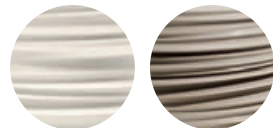

300  
chalk

308  
taupe

Polyethylene



off white

### DE MATERIAL

Aus Monolite Ipergres®: ein frostsicheres, wasserabweisendes Keramikmaterial mit ausgezeichneter Kratz- und Abriebfestigkeit. Aus produktionstechnischen Gründen hat der Beistelltisch keine vollständig ebene Oberfläche. Tischplatten aus Keramik werden in traditioneller Handarbeit gefertigt. Dadurch können Abweichungen entstehen, die jedes Stück zu einem unverwechselbaren Unikat machen. Einfach mit einem Tuch und warmem Wasser reinigen. In den Wintermonaten nicht abdecken und für ausreichend Luftzirkulation sorgen.

BABYLON PE ist aus rotationsgussgefertigtem Polyethylen hergestellt: einfach zu pflegen, gleichzeitig leicht und widerstandsfähig, 100% recyclingfähig. Zum Reinigen der Oberfläche verwenden Sie ein weiches Tuch, warmes Wasser und ein sanftes Reinigungsmittel, falls erforderlich.



For further BABYLON products see page 188



# BELLMONDE

Design by HENRIK PEDERSEN



Dining table L, ebony/black pepper



# BELLMONDE

Design by HENRIK PEDERSEN

## Typology

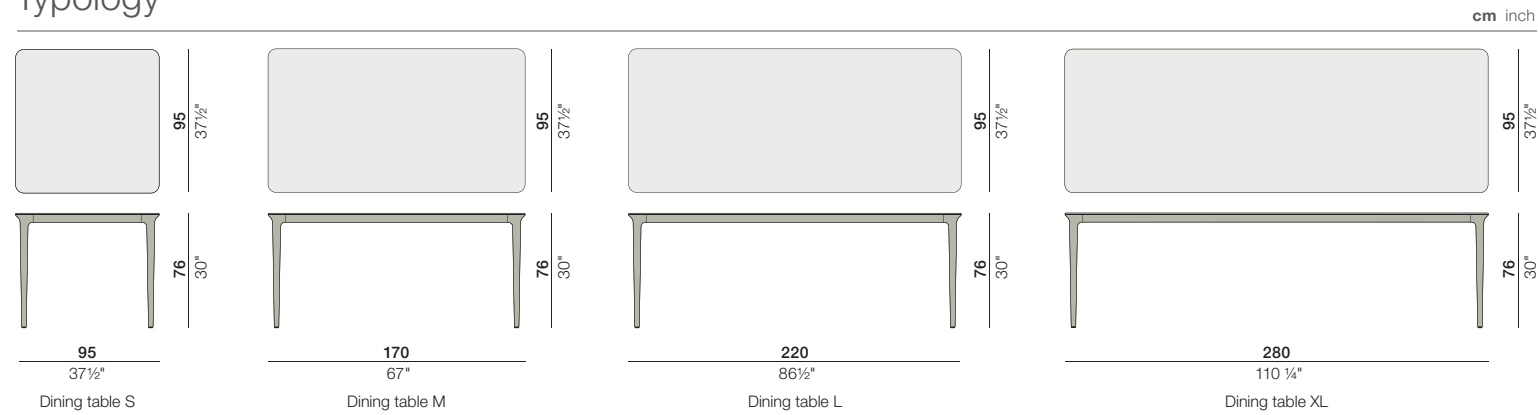

## Materials

### Base

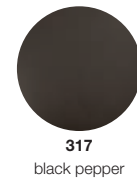

### Tabletops

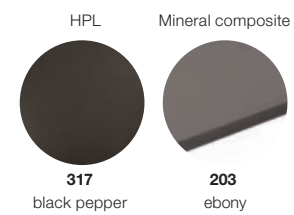

### EN MATERIAL

The BELLMONDE table is available with a HPL tabletop or a mineral composite tabletop. HPL is a material that is characterized by high impact resistance and extreme resistance to mechanical stress, moisture and steam. To clean a HPL tabletop use a soft cloth, warm water and a gentle cleanser if needed. The mineral composite table tops are waterproof and highly resistant to frost, UV-rays and abrasion. Clean with a soft cloth and warm water. The base is made of powder coated aluminum. Clean the powder coating with a soft cloth and warm water.

### DE MATERIAL

Der BELLMONDE Tisch ist verfügbar mit einer HPL Tischplatte oder einer Tischplatte aus Mineralkompositwerkstoff. HPL ist ein Material, das sich durch hohe Stoßfestigkeit und extreme Widerstandskraft gegen mechanische Einwirkungen, Feuchtigkeit und Dampf auszeichnet. Zur Reinigung eignen sich ein weiches Tuch, warmes Wasser und bei Bedarf ein sanftes Reinigungsmittel. Die Tischplatten aus Mineralkompositwerkstoff sind wasserfest und hochgradig frost-, UV-, und abriebresistent. Einfach mit einem weichen Tuch und warmem Wasser zu reinigen. Das Gestell ist aus pulverbeschichtetem Aluminium gefertigt. Auch dieses kann mit einem weichen Tuch und warmem Wasser gereinigt werden.

### RRP/UVP

#### DINING TABLE S Esstisch S

HPL  
95 x 95 cm  
37 1/2" x 37 1/2"  
26,6 kg  
59 lbs

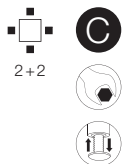
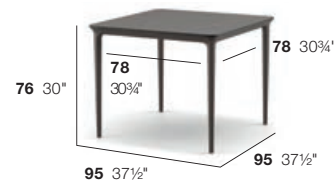
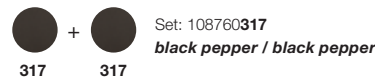

#### 108760317

Mineral Composite  
95 x 95 cm  
37 1/2" x 37 1/2"  
44,4 kg  
98 lbs



#### 108760203

5610806000

### RRP/UVP

#### DINING TABLE M Esstisch M

HPL  
95 x 170 cm  
37 1/2" x 67"  
41,5 kg  
92 lbs

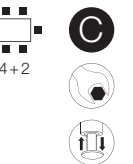
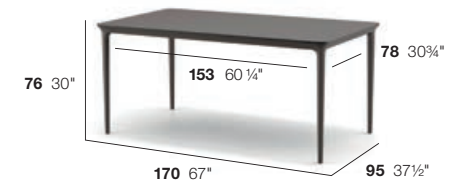
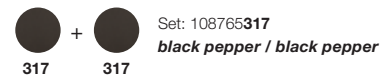

#### 108765317

Mineral Composite  
95 x 170 cm  
37 1/2" x 67"  
70,6 kg  
156 lbs

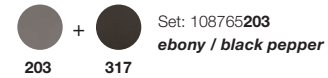

#### 108765203

#### DINING TABLE L Esstisch L

HPL  
95 x 220 cm  
37 1/2" x 86 1/2"  
51,3 kg  
114 lbs

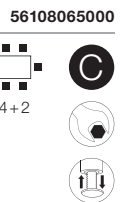
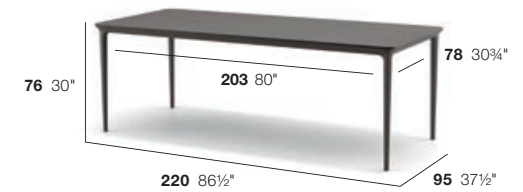
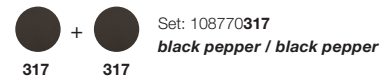

#### 108770317

Mineral Composite  
95 x 220 cm  
37 1/2" x 86 1/2"  
88,9 kg  
196 lbs

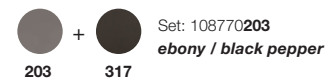

#### 108770203

#### DINING TABLE XL Esstisch XL

HPL  
95 x 280 cm  
37 1/2" x 110 1/4"  
62,7 kg  
139 lbs

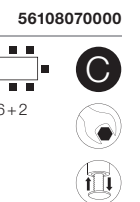
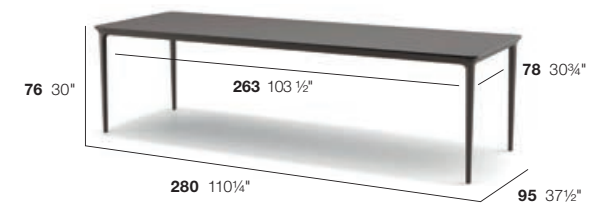
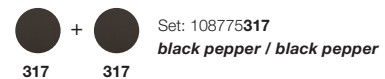

#### 108775317

Mineral Composite  
95 x 280 cm  
37 1/2" x 110 1/4"  
110,5 kg  
244 lbs

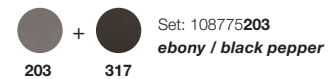

#### 108775203

### Complementary chairs



ROII Armchair  
See page 123



AllR Armchair  
See page 17



SEAX Armchair  
See page 143



MBRACE Armchair  
See page 77



# BRIXX

Design by LORENZA BOZZOLI



Sofa module M, GLAN drift | Side table triangular, lipari | Sofa module L, GLAN drift | Module S, GLAN drift | Sofa module M, GLAN drift | Side table triangular, lipari



Typology

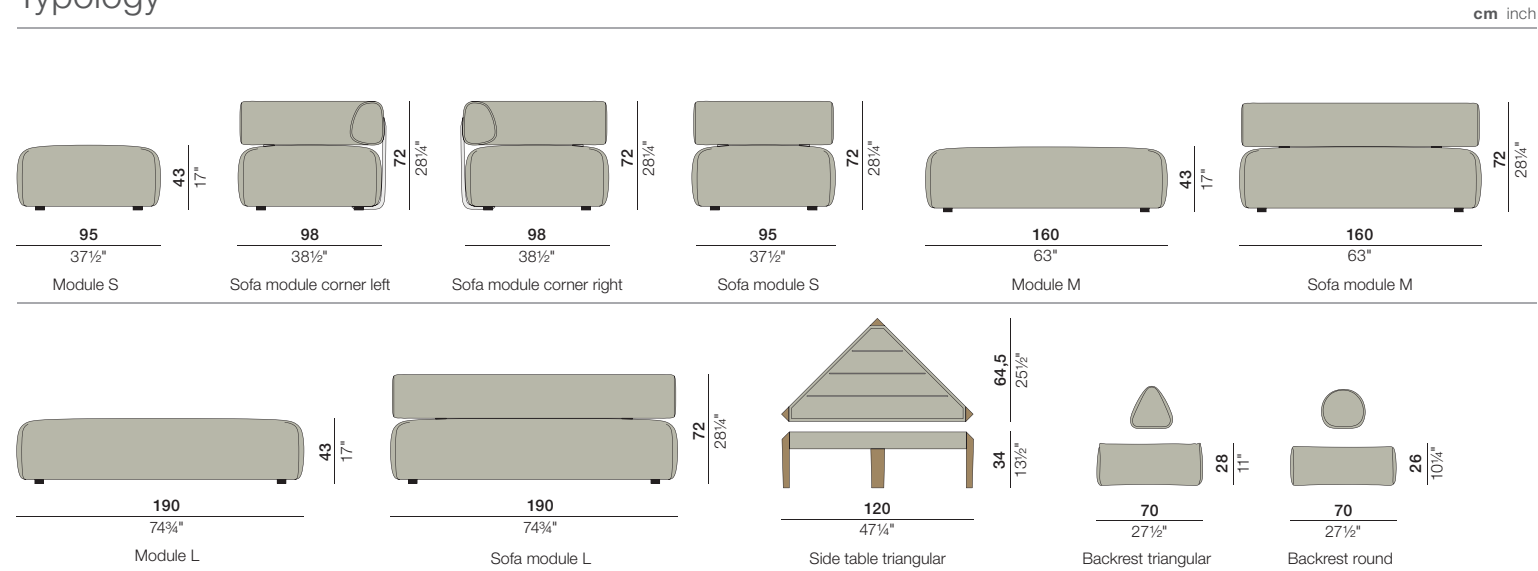

Materials

Fabric (page 224)

Items of this collection are available in all fabrics Cat. B & Cat. C.  
Artikel dieser Kollektion sind in den Stoffen der Kat. B & Kat. C verfügbar.

Backrest frame powder coating



304 lipari

RRP/UVF

MODULE S  
Modul S

95 x 95 cm  
28 kg  
37½" x 37½"  
62 lbs

43 17"  
95 37½"  
95 37½"

092016  
092016648  
56092016000

RRP/UVF

SOFA MODULE CORNER RIGHT  
Sofa Eckmodul rechts

98 x 98 cm  
48,3 kg  
38½" x 38½"  
107 lbs

72 28¼"  
98 38½"  
98 38½"

092018  
092018648  
56092018000

RRP/UVF

SOFA MODULE CORNER LEFT  
Sofa Eckmodul links

98 x 98 cm  
48,3 kg  
38½" x 38½"  
107 lbs

72 28¼"  
98 38½"  
98 38½"

092019  
092019648  
56092018000

RRP/UVF

SOFA MODULE S  
Sofa Modul S

98 x 95 cm  
39,8 kg  
38½" x 37½"  
88 lbs

72 28¼"  
98 38½"  
95 37½"

092017  
092017648  
56092017000

RRP/UVF

MODULE M  
Modul M

95 x 160 cm  
46,6 kg  
37½" x 63"  
103 lbs

43 17"  
95 37½"  
160 63"

092013  
092013648  
56092013000

RRP/UVF

SOFA MODULE M  
Sofa Modul M

98 x 160 cm  
60,3 kg  
38½" x 63"  
133 lbs

72 28¼"  
98 38½"  
160 63"

092012  
092012648  
56092012000

RRP/UVF

MODULE L  
Modul L

95 x 190 cm  
53,5 kg  
37½" x 74¾"  
118 lbs

43 17"  
95 37½"  
190 74¾"

092014  
092014648  
56092014000

RRP/UVF

SOFA MODULE L  
Sofa Modul L

98 x 190 cm  
70,7 kg  
38½" x 74¾"  
156 lbs

72 28¼"  
98 38½"  
190 74¾"

092015  
092015648  
56092015000

RRP/UVF

SIDE TABLE TRIANGULAR  
Beistelltisch dreieckig

17 kg  
38 lbs

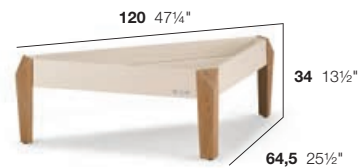

092035 092035098 56092035000

BACKREST TRIANGULAR  
Rückenlehne dreieckig

7,3 kg  
17 lbs

COM 0,90 M



BACKREST ROUND  
Rückenlehne rund

7,3 kg  
17 lbs

COM 0,90 M

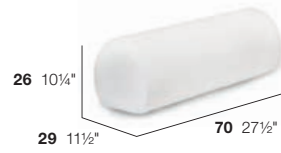

95092010 95092012

RECOMMENDED DECO CUSHIONS  
Empfohlene Dekokissen

DECO CUSHION  
Dekokissen

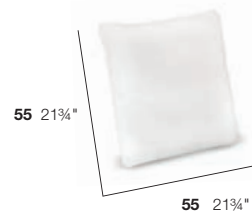

95092084

DECO CUSHION  
Dekokissen



95050091

### DRY+ CUSHION CONSTRUCTION

**EN DRY+ CUSHION**  
Dry+ cushions are protected by a highly water-repellent interlayer up to 10,000 mm. The triangular and round backrests are equipped with a heavy core and anti-slip pads in order to give ideal support.

**DE DRY+ KISSEN**  
Der Kern jedes Moduls wird durch eine stark wasserabweisende innere Hülle mit einer Wassersäule von 10.000 mm geschützt. Die dreieckigen und runden Rückenlehnen sind mit einem schweren Kern und rutschfestem Unterboden ausgestattet, wodurch sie ideal stützen.

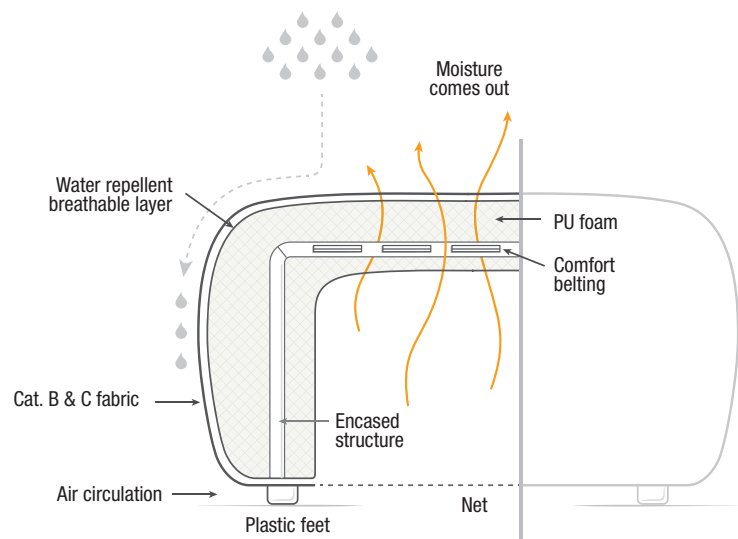

**EN MATERIAL**  
BRIX is a comfortable, upholstered modular system for indoor and outdoor use. Its structure consists of a powder coated steel frame encased in molded polyurethane foam. The side table consists of a powder coated metal top and natural teak legs.

**DE MATERIAL**  
BRIX ist ein komfortables, gepolstertes Modulare System, das Sie sowohl im Innen- als auch im Außenbereich nutzen können. Die Möbel dieser Kollektion bestehen aus pulverbeschichteten Stahlrahmen, die mit formgeschäumtem Polyurethanschaum verkleidet sind. Der Beistelltisch wird aus pulverbeschichtetem Metall und Beinen aus naturbelassenem Teakholz gefertigt.

**COVER**  
If not used under roof or awning, we recommend covering the modules with DEDON outdoor covers at night and during rainfall.

**HUSSEN**  
Wenn Sie die Möbel nicht auf einer überdachten Fläche oder unter einer Markise aufstellen, empfehlen wir die Module nachts und bei Regen mit DEDON Husen zu schützen.







BRIXX Setting 01

- 2x 00092016647 BRIXX Module S, LINEN flax
- 2x 00092019647 BRIXX Sofa module corner left, LINEN flax

RECOMMENDED DECO CUSHIONS:

- 1x 95050082648 Deco cushion 50 x 50 cm, LINEN umbra
- 2x 95050081814 Deco cushion 40 x 40 cm, Kvadrat® Atrium451
- 1x 95050081815 Deco cushion 40 x 40 cm, Kvadrat® Atrium351



BRIXX Setting 02

- 2x 00092012648 BRIXX Sofa module M, LINEN umbra
- 1x 00092019648 BRIXX Sofa module corner left, LINEN umbra
- 1x 00089040205 TIBBO Coffee table M, teak
- 1x 00089038205 TIBBO Coffee table S, teak
- 1x 00053084300 BABYLON Planter, chalk
- 1x 00053112000 BABYLON Stool / side table PE, incl. light

RECOMMENDED DECO CUSHIONS:

- 1x 95050091481 Deco cushion Ø 55 cm, NATURA mandarine
- 1x 95050082663 Deco cushion 50 x 50 cm, TWIST terracotta
- 1x 95050082476 Deco cushion 50 x 50 cm, NATURA marsala
- 1x 95050081663 Deco cushion 40 x 40 cm, TWIST terracotta



BRIXX Setting 03

- 1x 00092013706 BRIXX Module M, GLAN drift
- 1x 95092010707 BRIXX Backrest triangular, GLAN shale
- 1x 00092012707 BRIXX Sofa module M, GLAN shale
- 1x 00092015707 BRIXX Sofa module L, GLAN shale
- 2x 00092035098 BRIXX Side table, teak/lipari
- 1x 00101010000 LOON Floor lamp S
- 1x 00101030000 LOON Floor lamp L

RECOMMENDED DECO CUSHIONS:

- 1x 95050081660 Deco cushion 40 x 40 cm, TWIST beige
- 1x 95050082706 Deco cushion 50 x 50 cm, GLAN drift
- 1x 95050082480 Deco cushion 50 x 50 cm, NATURA laurel
- 1x 95050084706 Deco cushion 60 x 60 cm, GLAN drift
- 1x 95050084480 Deco cushion 60 x 60 cm, NATURA laurel



BRIXX Setting 04

- 1x 00092015660 BRIXX Sofa module L, TWIST beige
- 1x 00092019660 BRIXX Sofa module corner left, TWIST beige
- 1x 00092013660 BRIXX Module M, TWIST beige
- 2x 00073003168 DALA Club chair, bahamas
- 2x 95073202677 DALA Dry+ plush seat cushion, Kvadrat® Patio140
- 2x 95073203677 DALA Dry+ plush back cushion, Kvadrat® Patio140

- 1x 00073036167 DALA Side table, ibiza
- 1x 00073038167 DALA Coffee table, ibiza
- 1x 00073060167 DALA Lantern S, ibiza
- 1x 00073061167 DALA Lantern M, ibiza
- 1x 00073062167 DALA Lantern L, ibiza
- 2x 00098030124 VID Carpet fringes 200 x 300 cm, light gray

RECOMMENDED DECO CUSHIONS:

- 1x 95050081676 Deco cushion 40 x 40 cm, Kvadrat® Patio110
- 1x 95050081677 Deco cushion 40 x 40 cm, Kvadrat® Patio140
- 1x 95050081681 Deco cushion 40 x 40 cm, Kvadrat® Patio970
- 1x 95050082681 Deco cushion 50 x 50 cm, Kvadrat® Patio970
- 1x 95050084677 Deco cushion 60 x 60 cm, Kvadrat® Patio140



# DALA

Design by STEPHEN BURKS



- Lounge chair, ubud | Cushion: GLAN teal
- Lounge chair, cuba | Cushion: GLAN terra
- Lounge chair, ibiza | Cushion: GLAN drift
- Lounge chair, rioja | Cushion: GLAN shale
- Lounge chair, bahamas | Cushion: MAR nori





# DALA

Design by STEPHEN BURKS

## Typology

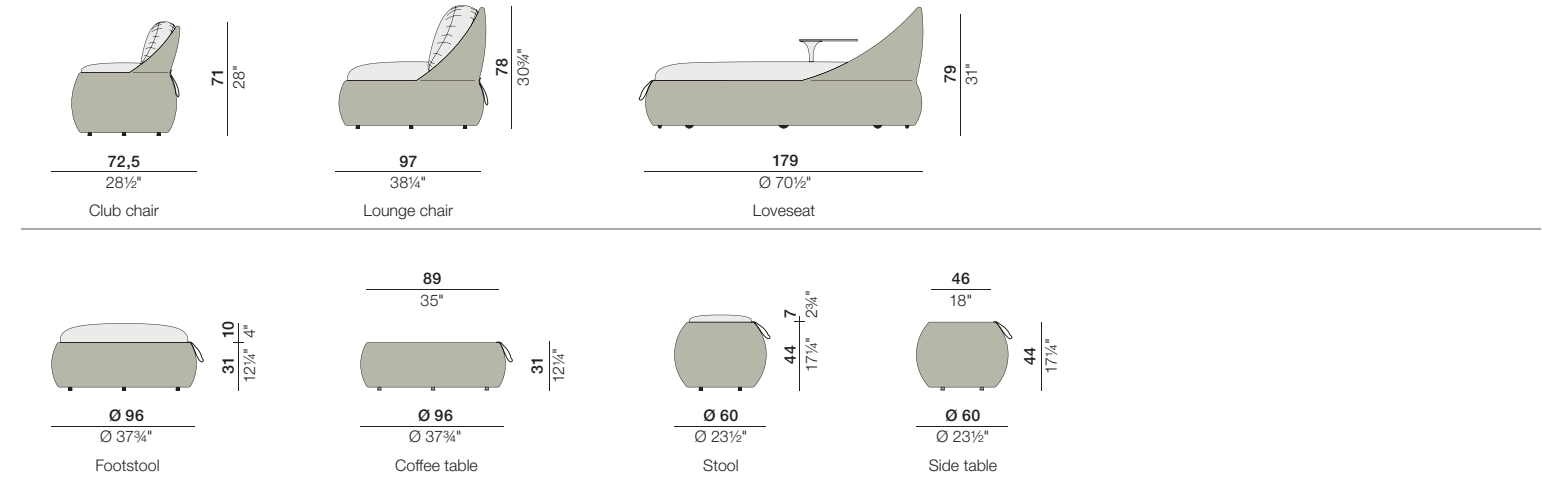

## Materials

### Combinations

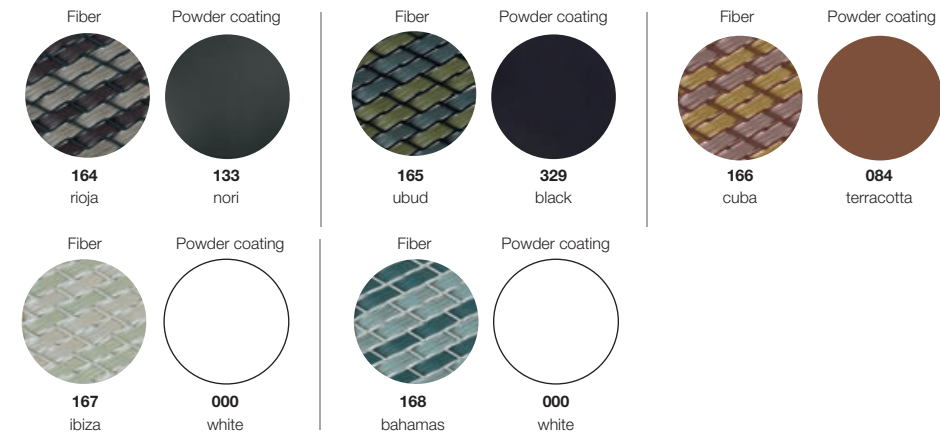

## Fabric Information (see page 224)

Cushions for this collection are available in all fabrics Cat. A, B, C.  
Kissen für diese Kollektion sind in allen Stoffen der Kat. A, B, C verfügbar.

### RRP/VP

<b>CLUB CHAIR</b> Club Chair 6,6 kg 15 lbs			DRY+ PLUSH SEAT CUSHION Dry+ Plush Sitzkissen COM 0,70 M	DRY+ PLUSH BACK CUSHION Dry+ Plush Rückenkissen COM 0,65 M	
<b>073003</b> <b>LOUNGE CHAIR</b> Sessel 9,3 kg 21 lbs			DRY+ PLUSH SEAT CUSHION Dry+ Plush Sitzkissen COM 1,30 M	DRY+ PLUSH BACK CUSHION Dry+ Plush Rückenkissen COM 1,25 M	
<b>073005</b> <b>STOOL</b> Hocker Ø 60 cm 4,5 kg Ø 23½" 10 lbs			DRY+ PLUSH SEAT CUSHION Dry+ Plush Sitzkissen COM 0,57 M		
<b>073035</b> <b>SIDE TABLE</b> Beistelltisch Ø 60 cm 6,8 kg Ø 23½" 15 lbs			Set: 073036164 Set: 073036165 Set: 073036166 Set: 073036167 Set: 073036168		
<b>073036</b> <b>FOOTSTOOL</b> Hocker Ø 96 cm 6,7 kg Ø 37¾" 15 lbs			DRY+ PLUSH SEAT CUSHION Dry+ Plush Sitzkissen COM 1,30 M		
<b>073037</b> <b>COFFEE TABLE</b> Kaffeetisch Ø 96 cm 17 kg Ø 37¾" 38 lbs			Set: 073038164 Set: 073038165 Set: 073038166 Set: 073038167 Set: 073038168		
<b>073038</b>			Set: 073038164		

### Tabletops glass

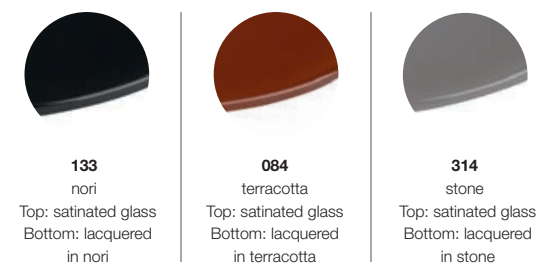



RRP/UVF

LOVESEAT  
Sofainsetel

Ø 179 cm  
30 kg  
Ø 70½"

66 lbs



79 31"  
58 22¾"



Ø 179 Ø 70½"  
073004164

DRY+ PLUSH SEAT CUSHION  
Dry+ Plush Sitzkissen  
COM 3,70 M

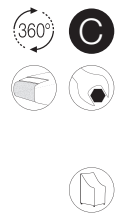

073004 95073214 56073014000

RECOMMENDED DECO CUSHIONS  
Empfohlene Dekokissen

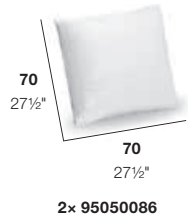

70  
27½"

70

27½"

2x 95050086

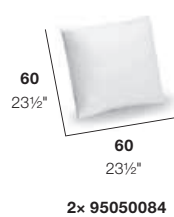

60  
23½"

60

23½"

2x 95050084

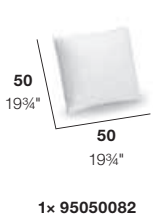

50  
19¾"

50

19¾"

1x 95050082

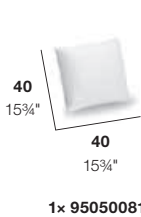

40  
15¾"

40

15¾"

1x 95050081

EN The loveseat is shipped with pre-mounted pullout casters.

DE Die Sofainsetel wird inkl. vormontierter ausklappbarer Räder geliefert.



EN MATERIAL

DALA furniture consist of DEDON fiber woven over a powder coated aluminum frame. To clean the surface, use a soft cloth or brush, warm water and a gentle cleanser if needed. The swiveling table of the DALA loveseat consists of a powder coated aluminum post and a tabletop of crosslaminated premium teak veneer.

DE MATERIAL

Die Möbel der DALA Kollektion bestehen aus DEDON-Faser, die auf einen pulverbeschichteten Aluminiumrahmen geflochten ist. Um die Oberfläche zu reinigen, benutzen Sie ein weiches Tuch oder eine weiche Bürste, warmes Wasser und, falls nötig, ein sanftes Reinigungsmittel. Der Schwenktisch der DALA Sofainsetel besteht aus einer pulverbeschichteten Aluminiumhalterung und einer Tischplatte aus hochwertigem Teak-Schichtholz.



For more DALA products see page 190







# IZON

Design by ARIK LEVY



Coffee table, Ø 111 cm, black pepper/lava | Coffee table, 50 x 130 cm, black pepper/lava



# IZON

Design by ARIK LEVY

## Typology

cm inch

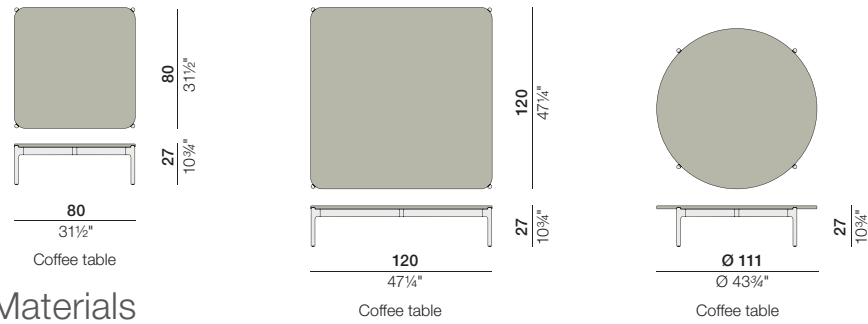
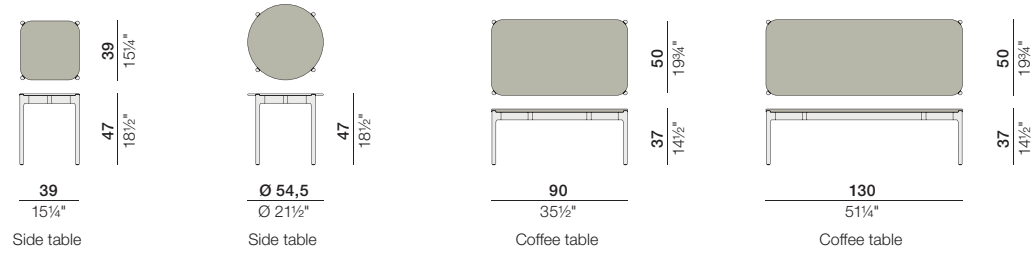

## Materials

### Frames



### Tabletops

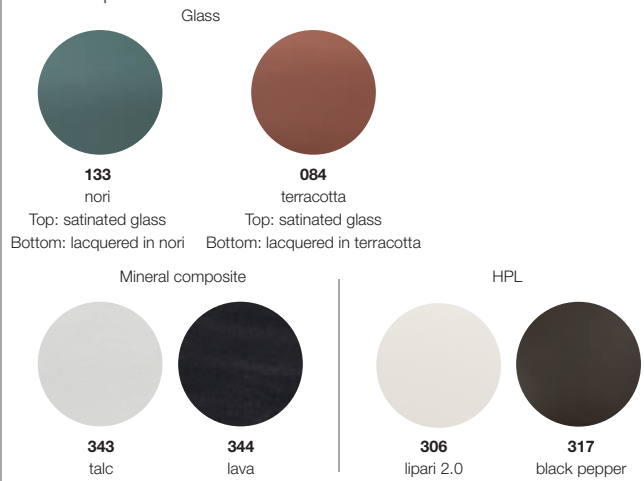

### RRP/UVF

#### SIDE TABLE

39 x 39 cm  
7,3 kg  
15 1/4" x 15 1/4"  
16 lbs

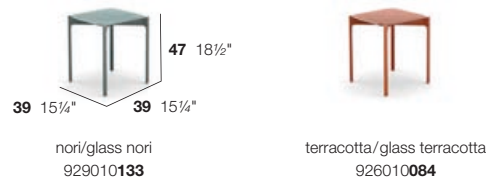

5,6 kg  
13 lbs



56900011000

### RRP/UVF

#### SIDE TABLE

Ø 54,5 cm  
8,5 kg  
Ø 21 1/2"  
19 lbs



nori/glass nori  
929020133



terracotta/glass terracotta  
926020084

6,3 kg  
14 lbs



lipari/HPL lipari 2.0  
913020306



black pepper/HPL black pepper  
917020317

56900021000

#### COFFEE TABLE

Ø 111 cm  
29 kg  
Ø 43 3/4"  
64 lbs



lipari/talc  
933050343



black pepper/lava  
937050344

16,4 kg  
37 lbs



lipari/HPL lipari 2.0  
913050306



black pepper/HPL black pepper  
917050317

56900051000

#### COFFEE TABLE

80 x 80 cm  
21,9 kg  
31 1/2" x 31 1/2"  
48 lbs

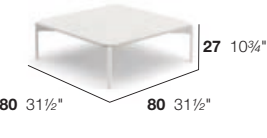

lipari/talc  
933030343



black pepper/lava  
937030344

12,6 kg  
28 lbs



lipari/HPL lipari 2.0  
913030306



black pepper/HPL black pepper  
917030317

56900031000



RRP/UVF

COFFEE TABLE  
Kaffeetisch

120 x 120 cm  
44,6 kg  
47 1/4" x 47 1/4"  
98 lbs

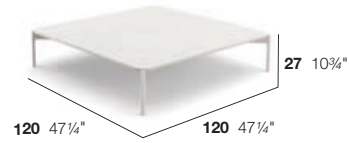

lipari/talc  
933040343



black pepper/lava  
937040344

24,1 kg  
54 lbs



lipari/HPL lipari 2.0  
913040306



black pepper/HPL black pepper  
917040317

56900041000

COFFEE TABLE  
Kaffeetisch

50 x 90 cm  
15,8 kg  
19 3/4" x 35 1/2"  
35 lbs



lipari/talc  
933060343



black pepper/lava  
937060344

9,9 kg  
22 lbs



lipari/HPL lipari 2.0  
913060306



black pepper/HPL black pepper  
917060317

56900061000

COFFEE TABLE  
Kaffeetisch

50 x 130 cm  
22,1 kg  
19 3/4" x 51 1/4"  
49 lbs

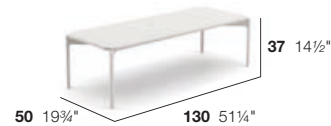

lipari/talc  
933070343



black pepper/lava  
937070344

12,9 kg  
29 lbs



lipari/HPL lipari 2.0  
913070306



black pepper/HPL black pepper  
917070317

56900071000

EN MATERIAL

The powder coated aluminium frames are available in four colours and three different heights and proportions.  
The tabletops consist of glass, HPL or mineral composite. To clean the surface, use a soft cloth, warm water and a gentle cleanser if needed.

DE MATERIAL

Die pulverbeschichteten Aluminiumrahmen der IZON Kollektion, sind in vier Farben und drei unterschiedlichen Höhen und Proportionen erhältlich.  
Die Tischplatten bestehen wahlweise aus Glas, HPL oder Mineralverbundmaterial. Zur Reinigung der Oberflächen eignen sich ein weiches Tuch, warmes Wasser und bei Bedarf ein sanftes Reinigungsmittel.

# IZON



### IZON Setting 01

1x 937060344 – Coffee table, 50 x 90 cm, black pepper/lava  
1x 926010084 – Side table, 39 x 39 cm, terracotta/glass terracotta



### IZON Setting 02

1x 913070306 – Coffee table, 50 x 130 cm, lipari/HPL lipari 2.0  
1x 913020306 – Side table, Ø 54,5 cm, lipari/HPL lipari 2.0



### IZON Setting 03

1x 933050343 – Coffee table, Ø 111 cm, lipari/talc  
1x 929020133 – Side table, Ø 54,5 cm, nori/glass nori

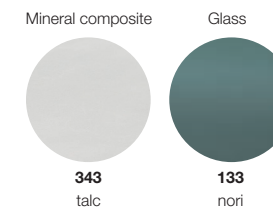

### IZON Setting 04

1x 937030344 – Coffee table, 80 x 80 cm, black pepper/lava  
1x 937060344 – Coffee table, 50 x 90 cm, black pepper/lava

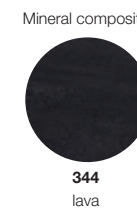

### IZON Setting 05

1x 937050344 – Coffee table, Ø 111 cm, black pepper/lava  
1x 937070344 – Coffee table, 50 x 130 cm, black pepper/lava

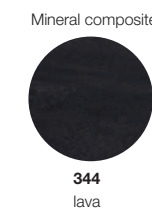

### IZON Setting 06

1x 933040343 – Coffee table, 120 x 120 cm, lipari/talc  
1x 933070343 – Coffee table, 50 x 130 cm, lipari/talc







# KIDA

Design by STEPHEN BURKS



Hanging lounge chair, glow touch



# KIDA

Design by STEPHEN BURKS

## Typology

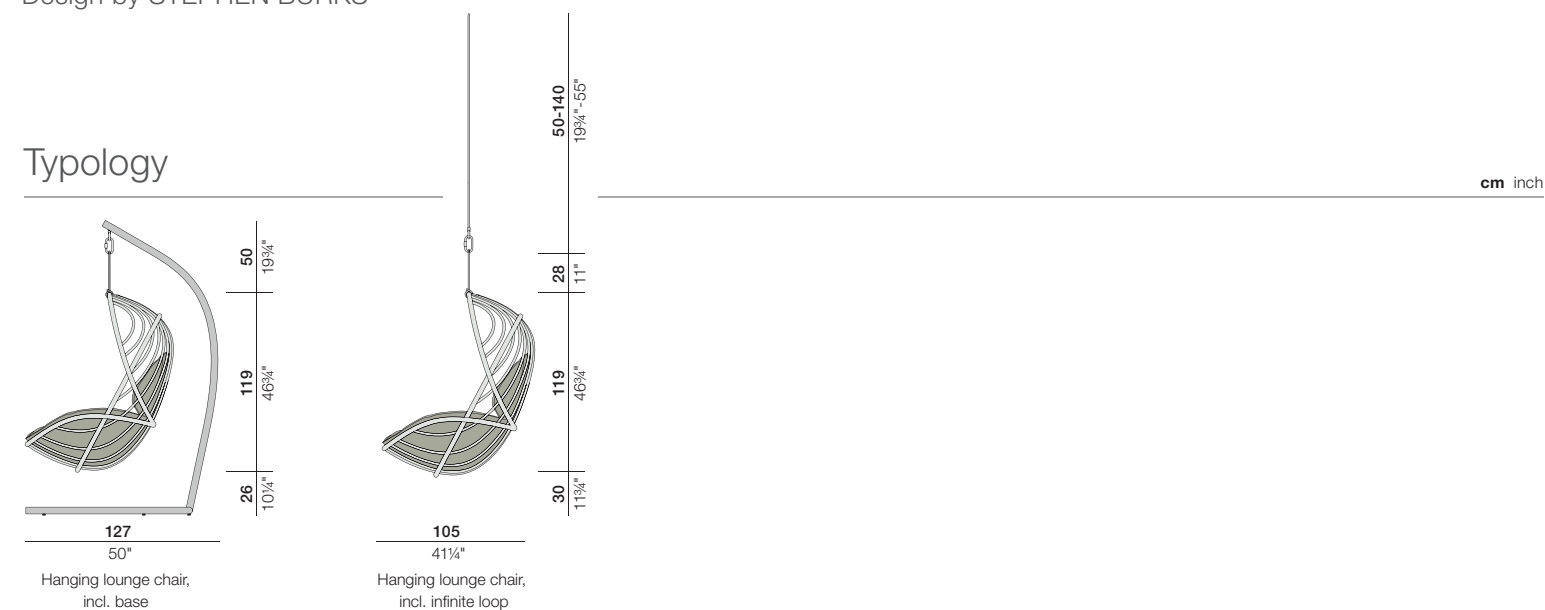

## Materials

### Fibers

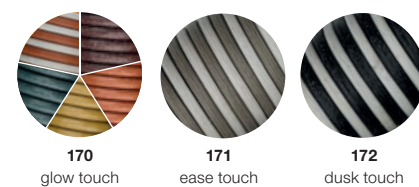

### Powder coating base



## Fabric Information (see page 224)

Items of this collection are available in all fabrics Cat. A, B & Cat. C (only Kvadrat® Atrium).  
 Artikel dieser Kollektion sind in den Stoffen der Kat. A, B & Kat. C (nur Kvadrat® Atrium) verfügbar.

### RRP/VP

HANGING LOUNGE CHAIR\*  
 INCL. INFINITE LOOP\*  
 Hängender Sessel,  
 inkl. Endlosschleife\*

9,2 kg  
 21 lbs

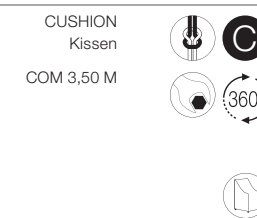
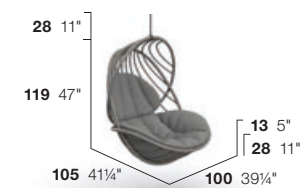

111005

HANGING LOUNGE CHAIR  
 INCL. BASE\*  
 Hängender Sessel,  
 inkl. Standfuß\*

28,9 kg  
 64 lbs

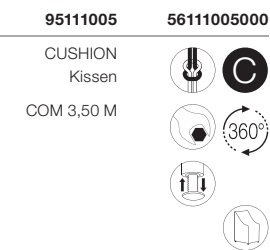
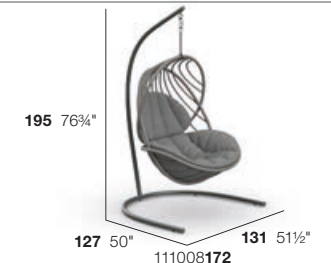

111008

**EN** \*ATTENTION  
 Weight capacity 120 kg/265 lbs. Safety distance: base area of the stand.

**MATERIAL**  
 KIDA furniture consist of DEDON fiber wrapped over a powder coated aluminum frame. To clean the surface, use a soft cloth or brush, warm water and a gentle cleanser if needed.  
 The base is made of powder coated stainless steel. Clean with a soft cloth and warm water.

**DE** \*ACHTUNG  
 Tragkraft 120 kg/265 lbs. Sicherheitsabstand: Grundfläche des Standfußes.

**MATERIAL**  
 Die Möbel der KIDA Kollektion bestehen aus DEDON-Faser, die auf einen pulverbeschichteten Aluminiumrahmen geflochten ist. Um die Oberfläche zu reinigen, benutzen Sie ein weiches Tuch oder eine weiche Bürste, warmes Wasser und, falls nötig, ein sanftes Reinigungsmittel.  
 Der Standfuß besteht aus pulverbeschichtetem rostfreiem Edelstahl und ist einfach mit einem weichen Tuch und warmem Wasser zu reinigen



# LEAF

Design by FRANK LIGTHART

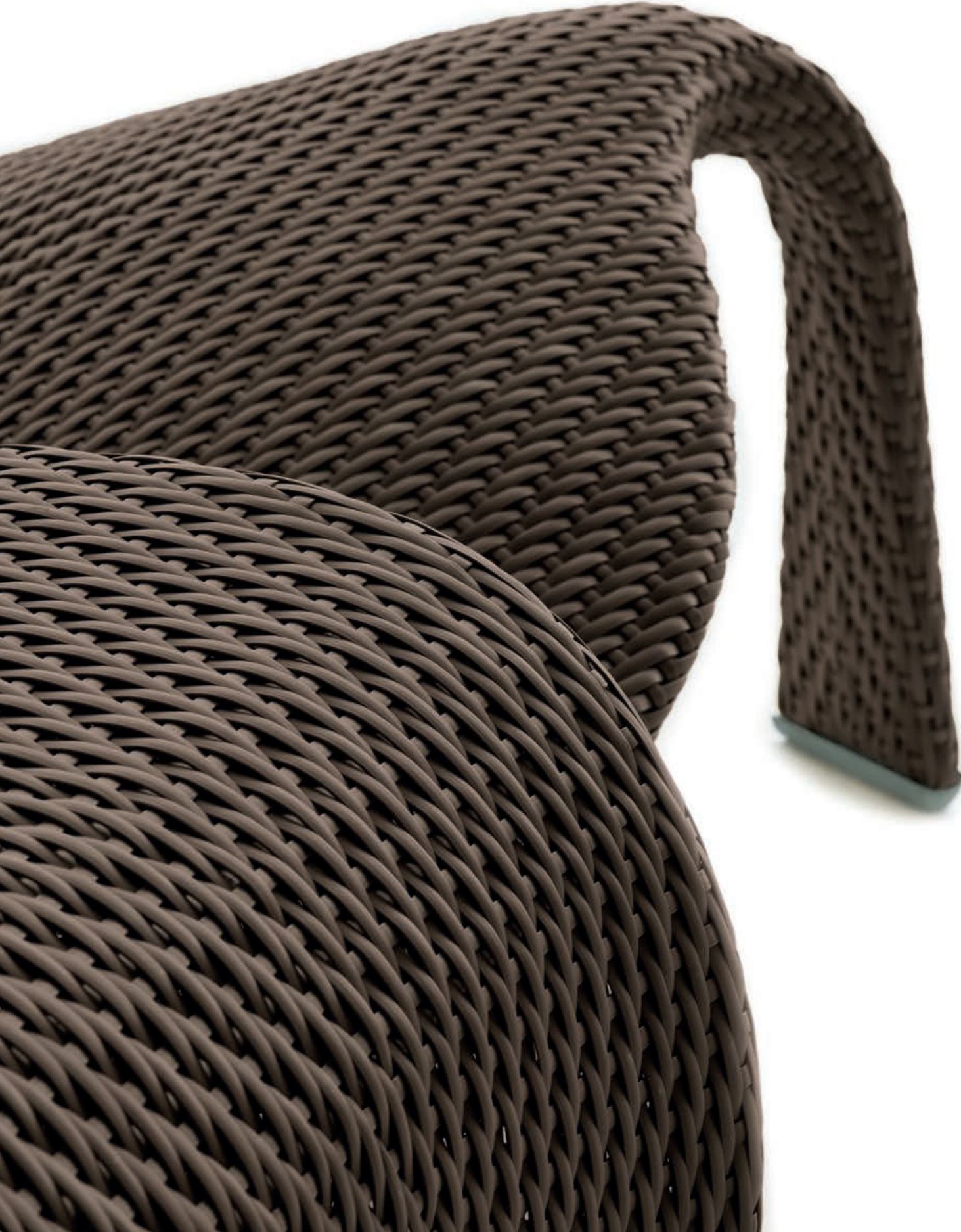

Beach chair XS, java

## Typology

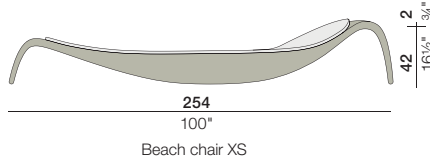

RRP/UVF

BEACH CHAIR XS  
Sonnenliege XS



018

15 kg  
33 lbs

## Materials

cm inch

Fiber



018

java

CUSHION  
Kissen

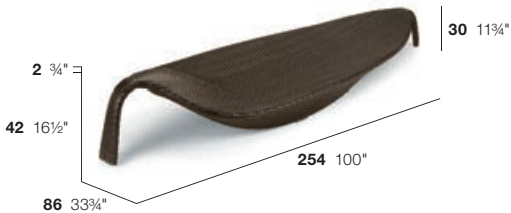

035018

035018018

99035018000

56035018000

### EN MATERIAL

LEAF beach chair XS consist of DEDON fiber woven over a powder coated aluminum frame. To clean the surface, use a soft cloth or brush, warm water and a gentle cleanser if needed. The special padded towel in the design of a leaf made of cotton is only available in this design and shape. It is washable at 30 °C/86 °F.

### DE MATERIAL

Die LEAF Sonnenliege besteht aus DEDON-Faser, die auf einen pulverbeschichteten Aluminiumrahmen geflochten ist. Um die Oberfläche zu reinigen, benutzen Sie ein weiches Tuch oder eine weiche Bürste, warmes Wasser und, falls nötig, ein sanftes Reinigungsmittel. Die Kissenauflage im Blatt-Design aus Baumwolle ist ausschließlich in dieser Farbe und Form erhältlich. Die Auflage ist bei 30 °C/86 °F waschbar.



# LOU

Design by TOAN NGUYEN

## Typology

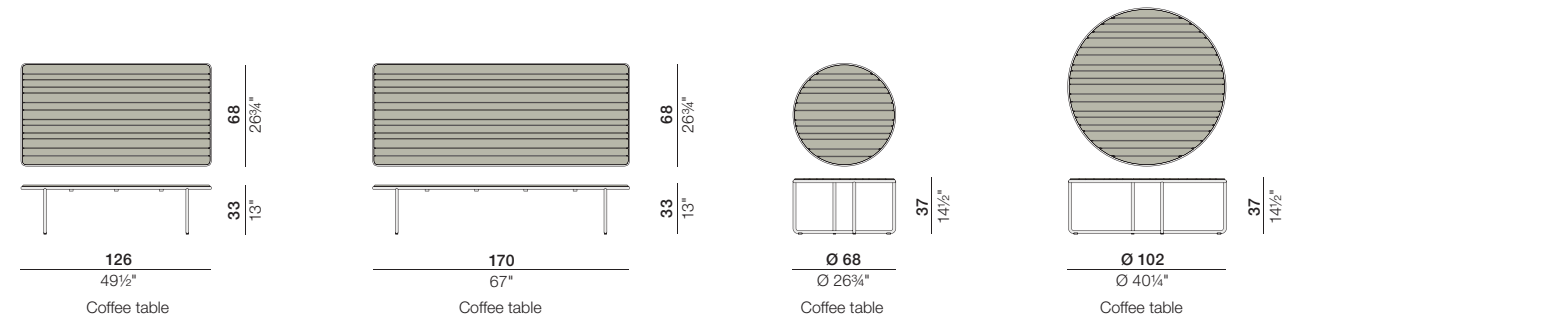

## Materials

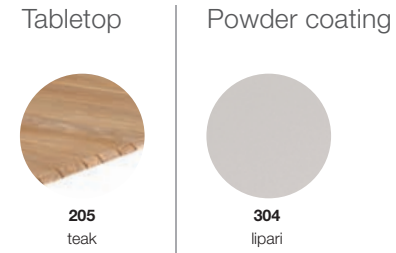

RRP/UVF

COFFEE TABLE  
Kaffeetisch

68 x 126 cm  
15,5 kg  
26 3/4" x 49 1/2"  
35 lbs



079035

079035205

56079035000

COFFEE TABLE  
Kaffeetisch

68 x 170 cm  
19 kg  
26 3/4" x 67"  
42 lbs



079037

079037205

56079037000

COFFEE TABLE  
Kaffeetisch

Ø 68 cm  
8,2 kg  
Ø 26 3/4"  
19 lbs



079036

079036205

56079036000

COFFEE TABLE  
Kaffeetisch

Ø 102 cm  
15,3 kg  
Ø 40 1/4"  
34 lbs



079034

079034205

56079034000

### EN MATERIAL

LOU coffee tables come in two different shapes and four sizes, the round ones overlapping the square ones. These coffee tables feature a premium teak tabletop on a base of powder coated stainless steel. Wash the teak surface using DEDON teak cleaner. To retain the golden-brown color of unweathered teak, we recommend applying DEDON teak oil at least once in every six months. Clean the powder coating with a soft cloth and warm water.

### DE MATERIAL

Die Kaffeetische der LOU Kollektion sind in zwei unterschiedlichen Formen und vier Größen erhältlich, wobei die runden die eckigen überlappen. Diese Kaffeetische bestehen aus einer hochwertigen Teakholz-Tischplatte und einem Gestell aus pulverbeschichtetem Edelstahl. Reinigen Sie das Teakholz mit DEDON Teak Reiniger. Um den ursprünglichen goldbraunen Farbton zu bewahren, tragen Sie mindestens alle sechs Monate das DEDON Teak Öl auf. Reinigen Sie die Pulverbeschichtung mit einem weichen Tuch und warmem Wasser.





# LOUNGE

Design by FRANK LIGTHART



Right module, bleach  
Corner module, bleach  
Center module, bleach  
Left module, bleach  
Coffee table, bleach

Cushion: NATURA dark gray





# LOUNGE

Design by FRANK LIGTHART

## Typology

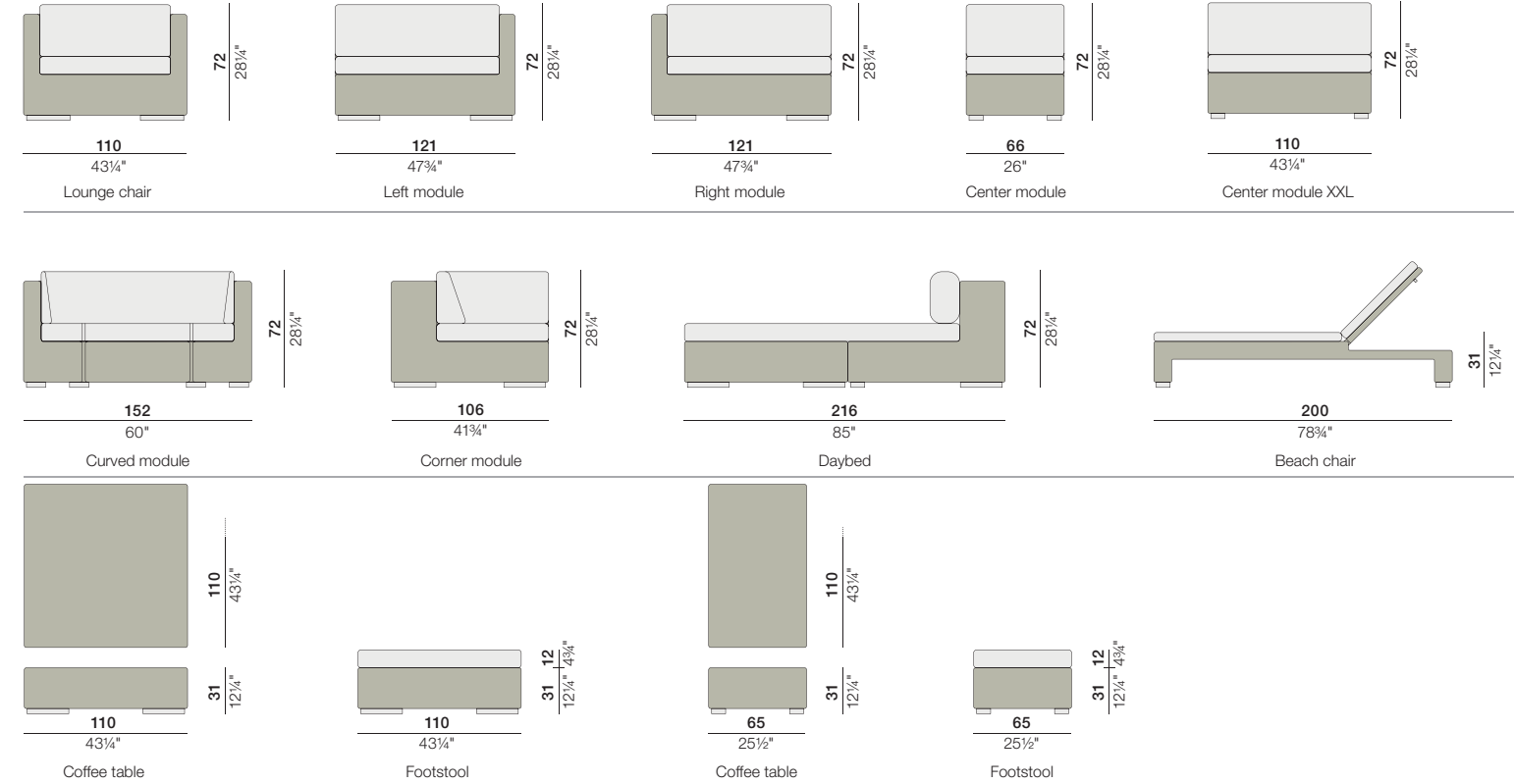

## Materials



## Fabric Information (see page 224)

Items of this collection are available in all fabrics Cat. A, B & Cat. C (only Kvadrat® Atrium).  
 Artikel dieser Kollektion sind in den Stoffen der Kat. A, B & Kat. C (nur Kvadrat® Atrium) verfügbar.

RRP/UDP

LOUNGE CHAIR  
Sessel

21 kg  
47 lbs

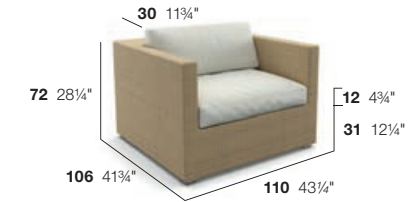

PLUSH SEAT CUSHION + BACK CUSHION \*  
Plush Sitzkissen + Rückenkissen \*  
COM 2,83 M



029008

LEFT MODULE  
Modul links

19 kg  
42 lbs

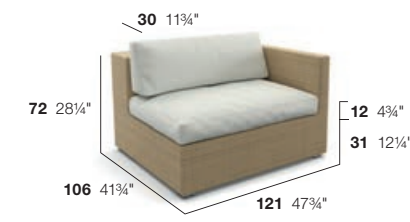

PLUSH SEAT CUSHION + BACK CUSHION \*  
Plush Sitzkissen + Rückenkissen \*  
COM 3,40 M



029005

RIGHT MODULE  
Modul rechts

19 kg  
42 lbs

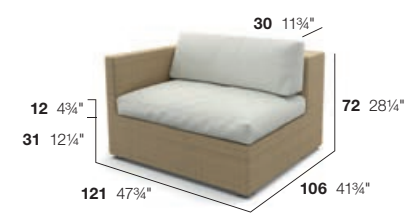

PLUSH SEAT CUSHION + BACK CUSHION \*  
Plush Sitzkissen + Rückenkissen \*  
COM 3,40 M



029003

CENTER MODULE  
Modul mitte

11,5 kg  
26 lbs

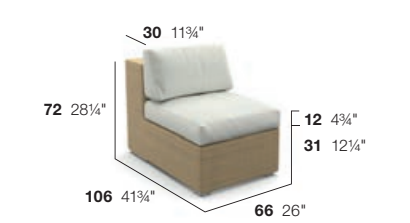

PLUSH SEAT CUSHION + BACK CUSHION \*  
Plush Sitzkissen + Rückenkissen \*  
COM 2,05 M



029001

CENTER MODULE XXL  
Modul mitte XXL

16 kg  
36 lbs

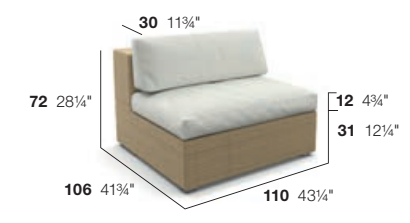

PLUSH SEAT CUSHION + BACK CUSHION \*  
Plush Sitzkissen + Rückenkissen \*  
COM 3,40 M



029002

CURVED MODULE  
Bogenmodul

16 kg  
36 lbs

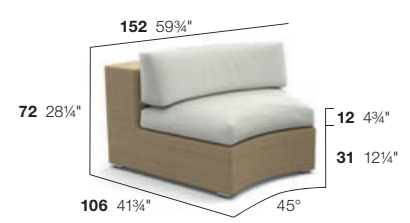

PLUSH SEAT CUSHION + BACK CUSHION \*  
Plush Sitzkissen + Rückenkissen \*  
COM 3,75 M



029006

RECOMMENDED DECO CUSHIONS  
Empfohlene Dekokissen



95050082

95050081



RRP/UVF

CORNER MODULE  
Eckmodul

18 kg  
40 lbs

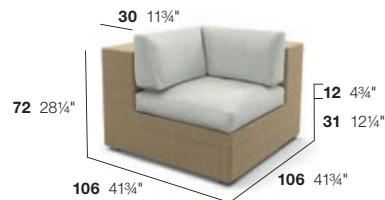
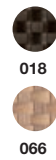

029007

029007066

PLUSH SEAT CUSHION + CORNER BACK CUSHION \*  
Plush Sitzkissen + Rückenkissen über Eck \*

COM 3,40 M



Set 95029207

PLUSH SEAT CUSHION + ONE-SIDED BACK CUSHION \*  
Plush Sitzkissen + 1-seitiges Rückenkissen \*

COM 2,19 M



Set 95029217 56029007000

FOOTSTOOL  
Hocker

110 x 110 cm  
10,5 kg  
43 1/4" x 43 1/4"  
24 lbs

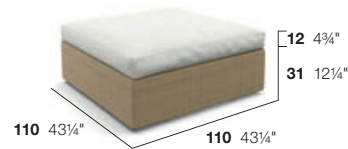
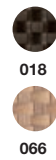

029037

029037066

PLUSH SEAT CUSHION  
Plush Sitzkissen

COM 2,32 M



95029237 56029030000

COFFEE TABLE  
Kaffeetisch

110 x 110 cm  
28 kg  
43 1/4" x 43 1/4"  
62 lbs

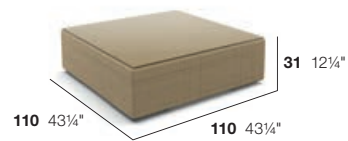

029038

Set: 029038066



56029037000

FOOTSTOOL  
Hocker

65 x 110 cm  
7 kg  
25 1/2" x 43 1/4"  
15 lbs



029035

029035066

PLUSH SEAT CUSHION  
Plush Sitzkissen

COM 1,84 M



95029235 56029031000

COFFEE TABLE  
Kaffeetisch

65 x 110 cm  
17,5 kg  
25 1/2" x 43 1/4"  
38 lbs

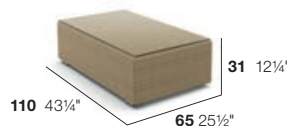

029036

Set: 029036066



56029035000

\* EN Back cushion

\* DE Rückenkissen

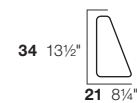

\*\* EN Back cushion  
Only for LOUNGE Daybed

\*\* DE Rückenkissen  
Nur für LOUNGE Daybed

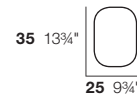

RRP/UVF

DAYBED  
Daybed

26 kg  
60 lbs

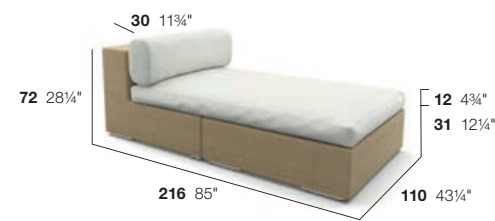
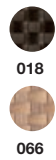

029002 + 029037

029002066 + 029037066

PLUSH SEAT CUSHION + BACK CUSHION  
Plush Sitzkissen + Rückenkissen

COM 5,05 M



Set 95029218

BEACH CHAIR  
WITH GAS SPRING  
Sonnenliege  
mit Gasdruckfeder

22,5 kg  
50 lbs

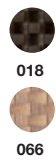

029119

029119066

PLUSH CUSHION  
Plush Kissen

COM 3,05 M



95029219 56029019000

EN MATERIAL

LOUNGE furniture consists of DEDON fiber woven over a powder coated aluminum frame. To clean the surface, use a soft cloth or brush, warm water and a gentle cleanser if needed. To clean the glass tabletop, use a soft cloth, warm water and a gentle cleanser if needed.

DE MATERIAL

Die Möbel der LOUNGE Kollektion bestehen aus DEDON-Faser, die auf einen pulverbeschichteten Aluminiumrahmen geflochten ist. Um die Oberfläche zu reinigen, benutzen Sie ein weiches Tuch oder eine weiche Bürste, warmes Wasser und, falls nötig, ein sanftes Reinigungsmittel. Zur Reinigung der Glas-Tischplatte eignen sich ein weiches Tuch, warmes Wasser und bei Bedarf ein sanftes Reinigungsmittel.



# LOUNGE

Design by FRANK LIGTHART



LOUNGE Setting 01

1x 00029007066	LOUNGE	Corner module, bleach	1x 00029001066	LOUNGE	Center module, bleach
1x 95029207478	LOUNGE	Plush cushion set, NATURA ash	1x 95029201478	LOUNGE	Plush cushion set, NATURA ash
1x 00029002066	LOUNGE	Center module XXL, bleach	1x 00029036066	LOUNGE	Coffee table 65 x 110 cm, bleach
1x 95029202478	LOUNGE	Plush cushion set, NATURA ash	1x 00029038066	LOUNGE	Coffee table 110 x 110 cm, bleach
1x 00029006066	LOUNGE	Curved module, bleach	1x 00101030000	LOON	Floor lamp L
1x 95029206478	LOUNGE	Plush cushion set, NATURA ash	1x 00101010000	LOON	Floor lamp S

RECOMMENDED DECO CUSHIONS:

1x 95050081478	Deco cushion	40 x 40 cm, NATURA ash
1x 95050081475	Deco cushion	40 x 40 cm, NATURA marengo
1x 95050082478	Deco cushion	50 x 50 cm, NATURA ash
2x 95050084474	Deco cushion	60 x 60 cm, NATURA dark gray



LOUNGE Setting 02

1x 00029003018	LOUNGE	Right module, java	1x 00029036018	LOUNGE	Coffee table 65 x 110 cm, java
1x 95029203647	LOUNGE	Plush cushion set, LINEN flax	1x 00035018018	LEAF	Beach chair XS, java
2x 00029006018	LOUNGE	Curved module, java	1x 99035018000	LEAF	Cushion
2x 95029206647	LOUNGE	Plush cushion set, LINEN flax	1x 00087032116	PORCINI	Coffee table Ø 100 cm, marrone
1x 00029005018	LOUNGE	Left module, java	1x 00087034116	PORCINI	Side table Ø 61 cm, marrone
1x 95029205647	LOUNGE	Plush cushion set, LINEN flax	1x 00087036116	PORCINI	Side table Ø 51 cm, marrone

RECOMMENDED DECO CUSHIONS:

2x 95050081649	Deco cushion	40 x 40 cm, LINEN ebony
1x 95050081660	Deco cushion	40 x 40 cm, TWIST beige
2x 95050082814	Deco cushion	50 x 50 cm, Kvadrat® Atrium451
1x 95050082649	Deco cushion	50 x 50 cm, LINEN ebony
1x 95050084660	Deco cushion	60 x 60 cm, TWIST beige



LOUNGE Setting 03

2x 00029003066	LOUNGE	Right module, bleach	1x 95029208476	LOUNGE	Plush cushion set NATURA marsala
2x 95029203476	LOUNGE	Plush cushion set NATURA marsala	1x 00079037205	LOU	Coffee table 68 x 170 cm, lipari/teak
2x 00029005066	LOUNGE	Left module, bleach	1x 00079036205	LOU	Coffee table Ø 68 cm, lipari/teak
2x 95029205476	LOUNGE	Plush cushion set, NATURA marsala	1x 00073051167	DALA	Planter L, ibiza
1x 00029002066	LOUNGE	Center module XXL, bleach	1x 00073050166	DALA	Planter S, cuba
1x 95029202476	LOUNGE	Plush cushion set, NATURA marsala	1x 00098025125	VID	Carpet solid 300 x 400 cm, canvas
1x 00029008066	LOUNGE	Lounge chair, bleach			

RECOMMENDED DECO CUSHIONS:

3x 95050081470	Deco cushion	40 x 40 cm, NATURA white
1x 95050081650	Deco cushion	40 x 40 cm, LINEN off white
2x 95050082650	Deco cushion	50 x 50 cm, LINEN off white
2x 95050082470	Deco cushion	50 x 50 cm, NATURA white
1x 95050084650	Deco cushion	60 x 60 cm, LINEN off white



LOUNGE Setting 04

1x 00029003018	LOUNGE	Right module, java	1x 95029205816	LOUNGE	Plush cushion set, Kvadrat® AtriumD11
1x 95029203816	LOUNGE	Plush cushion set, Kvadrat® AtriumD11	1x 00029037018	LOUNGE	Footstool 110 x 110 cm, java
1x 00029002018	LOUNGE	Center module XXL, java	1x 95029237816	LOUNGE	Plush seat cushion, Kvadrat® AtriumD11
1x 95029202816	LOUNGE	Plush cushion set, Kvadrat® AtriumD11	1x 00917070317	IZON	Coffee table 50 x 130 cm, HPL black pepper
1x 00029036018	LOUNGE	Coffee table 65 x 110 cm, java	1x 00073051164	DALA	Planter L, rioja
1x 00029005018	LOUNGE	Left module, java	1x 00073050164	DALA	Planter S, rioja

RECOMMENDED DECO CUSHIONS:

1x 95050081663	Deco cushion	40 x 40 cm, TWIST terracotta
1x 95050081685	Deco cushion	40 x 40 cm, MAR terracotta
2x 95050082663	Deco cushion	50 x 50 cm, TWIST terracotta
1x 95050084685	Deco cushion	60 x 60 cm, MAR terracotta



# MBARQ

Design by SEBASTIAN HERKNER



3-seater, high backrest, chestnut | Cushion: TWIST terracotta | Additional back cushions: NATURA marsala | MBACE side tables



# MBARQ

Design by SEBASTIAN HERKNER

## Typology

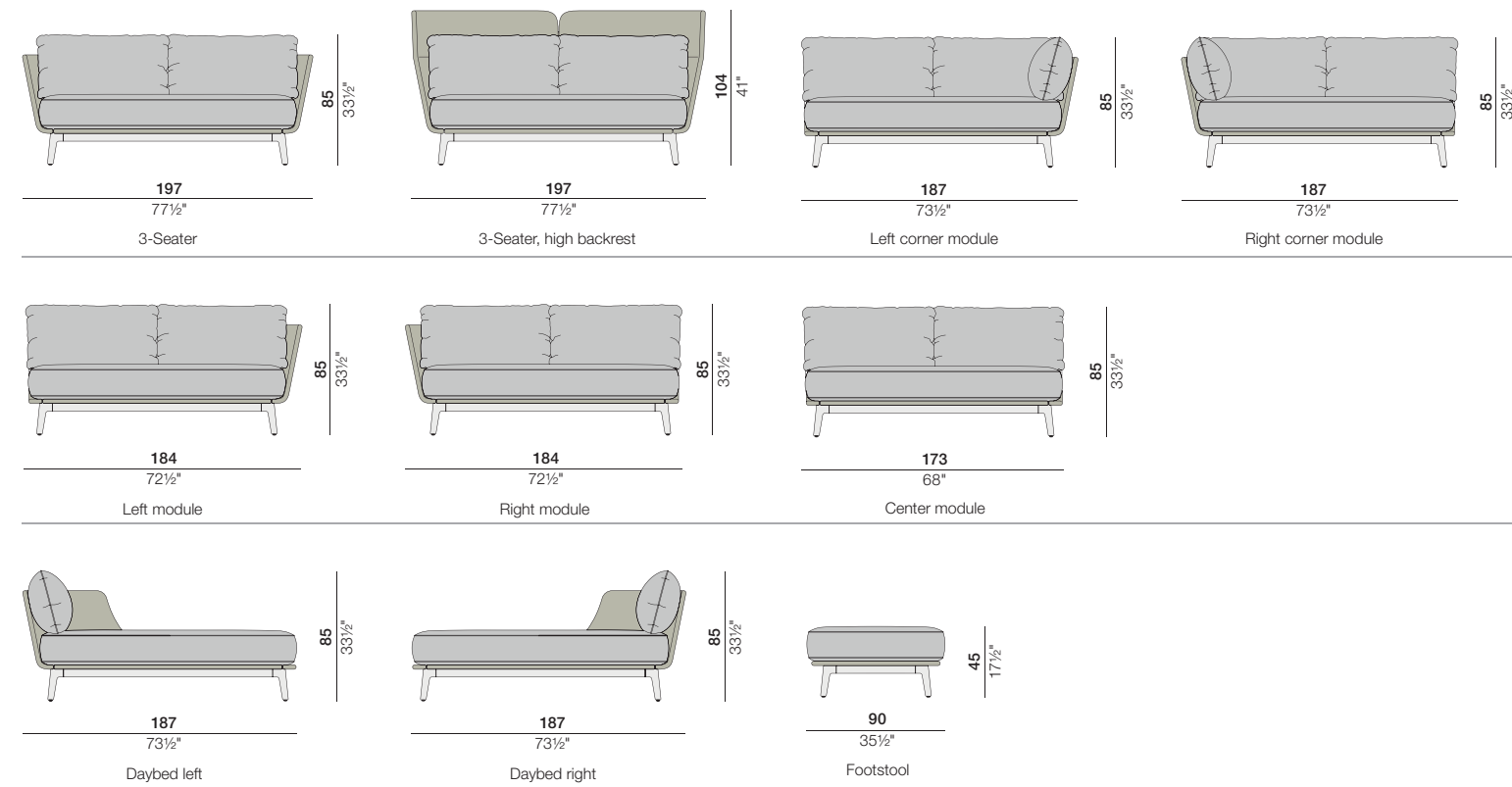

## Materials

### Combinations

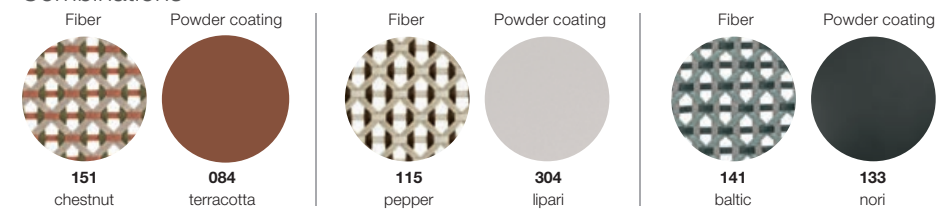

## Fabric Information (see page 224)

Cushions for this collection are available in all fabrics Cat. A, B, C.  
Kissen für diese Kollektion sind in allen Stoffen der Kat. A, B, C verfügbar.

RRP/UVF

3-SEATER  
3er-Sofa

23,6 kg  
52 lbs



DRY+ CUSHION SET  
Dry+ Kissen-set  
COM 4,50 M

DRY+ ADDITIONAL BACK CUSHION  
Dry+ zusätzliches Rücken-kissen  
COM 0,80 M



109015

3-SEATER, HIGH BACKREST  
3-Sitzer, hohe Rückenlehne

28 kg  
62 lbs



DRY+ CUSHION SET  
Dry+ Kissen-set  
COM 4,50 M

DRY+ ADDITIONAL BACK CUSHION  
Dry+ zusätzliches Rücken-kissen  
COM 0,80 M



109016

LEFT CORNER MODULE  
Eckmodul links

23 kg  
51 lbs



DRY+ CUSHION SET  
Dry+ Kissen-set  
COM 5,40 M

DRY+ ADDITIONAL BACK CUSHION  
Dry+ zusätzliches Rücken-kissen  
COM 0,80 M



109006

RIGHT CORNER MODULE  
Eckmodul rechts

23 kg  
51 lbs



DRY+ CUSHION SET  
Dry+ Kissen-set  
COM 5,40 M

DRY+ ADDITIONAL BACK CUSHION  
Dry+ zusätzliches Rücken-kissen  
COM 0,80 M



109004

LEFT MODULE  
Modul links

22,7 kg  
50 lbs



DRY+ CUSHION SET  
Dry+ Kissen-set  
COM 4,50 M

DRY+ ADDITIONAL BACK CUSHION  
Dry+ zusätzliches Rücken-kissen  
COM 0,80 M



109005

RIGHT MODULE  
Modul rechts

22,7 kg  
50 lbs



DRY+ CUSHION SET  
Dry+ Kissen-set  
COM 4,50 M

DRY+ ADDITIONAL BACK CUSHION  
Dry+ zusätzliches Rücken-kissen  
COM 0,80 M



109003

CENTER MODULE  
Modul mitte

21,8 kg  
48 lbs



DRY+ CUSHION SET  
Dry+ Kissen-set  
COM 4,50 M

DRY+ ADDITIONAL BACK CUSHION  
Dry+ zusätzliches Rücken-kissen  
COM 0,80 M



109001

3-SEATER

23,6 kg  
52 lbs



DRY+ CUSHION SET  
Dry+ Kissen-set  
COM 4,50 M

DRY+ ADDITIONAL BACK CUSHION  
Dry+ zusätzliches Rücken-kissen  
COM 0,80 M





RRP/UVF

DAYBED LEFT  
Daybed links

18,2 kg  
40 lbs



DRY+ CUSHION SET  
Dry+ Kissen-set

DRY+ ADDITIONAL BACK CUSHION  
Dry+ zusätzliches Rücken-kissen



109017115

Set 95109217

95109290

56109017000

DAYBED RIGHT  
Daybed rechts

18,2 kg  
40 lbs



DRY+ CUSHION SET  
Dry+ Kissen-set

DRY+ ADDITIONAL BACK CUSHION  
Dry+ zusätzliches Rücken-kissen



109018115

Set 95109217

95109290

56109018000

FOOTSTOOL  
Hocker

13,7 kg  
30 lbs

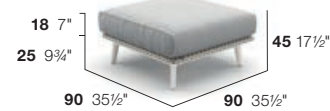

DRY+ SEAT CUSHION  
Dry+ Sitzkissen



109035115

95109235

56109035000

EN MATERIAL

MBARQ furniture consists of DEDON Fiber woven over a powder coated aluminum frame. MBARQ employs the same open, vibrant triaxial weave pattern used by its cousin, MBRACE. The Seat is made of tensiline® fabric. To clean the surface, use a soft cloth or brush, warm water and a gentle cleanser, if needed.

DE MATERIAL

Die Möbel der MBARQ-Kollektion bestehen aus DEDON-Faser, die auf einen pulverbeschichteten Aluminiumrahmen geflochten ist. Für MBARQ verwenden wir dasselbe offene und lebendige, dreiachsige Webmuster wie für unsere MBRACE-Serie. Die Sitzfläche besteht aus Tensiline® Stoff. Um die Oberfläche zu reinigen, benutzen Sie ein weiches Tuch oder eine weiche Bürste, warmes Wasser und, falls nötig, ein sanftes Reinigungsmittel.

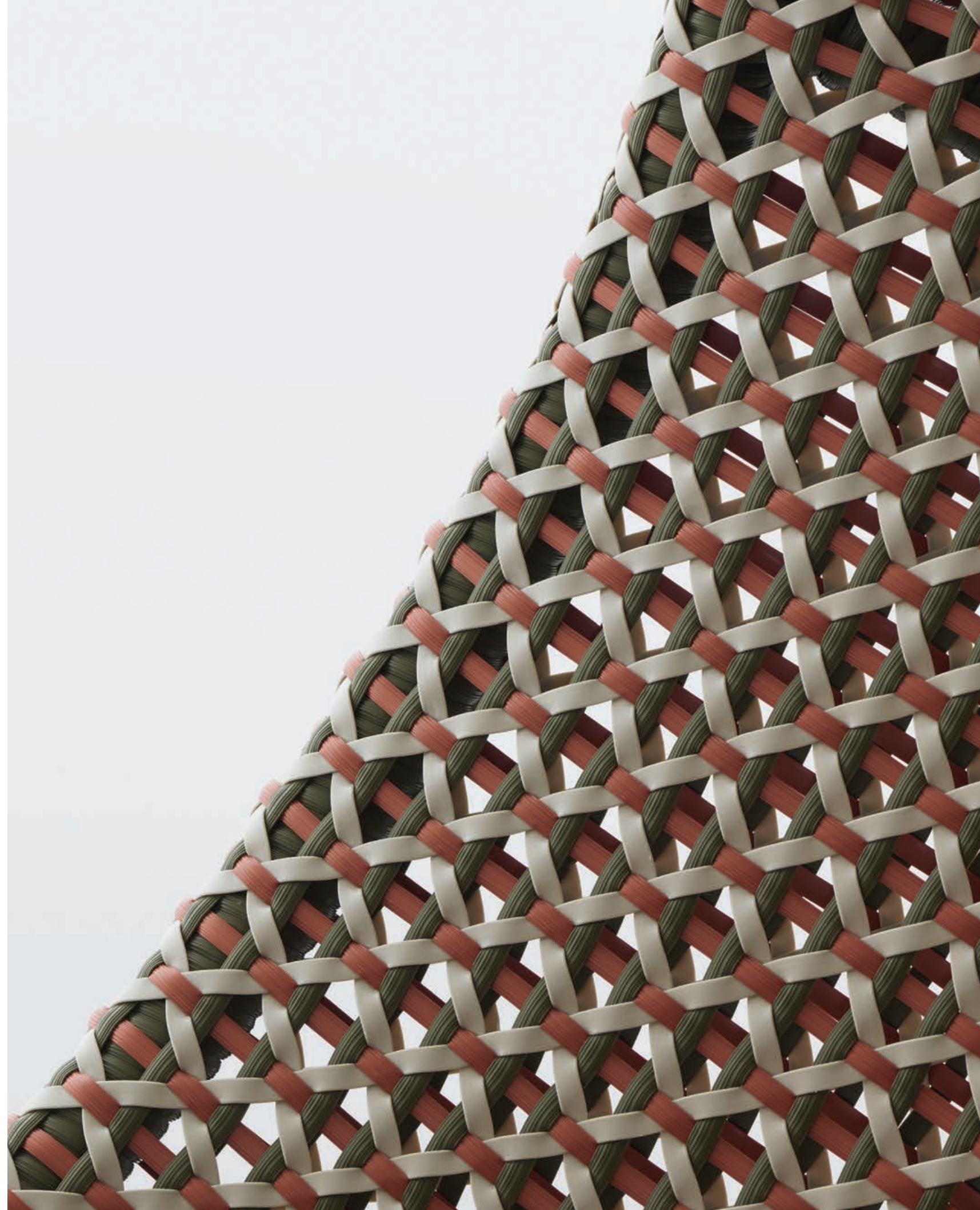



# MBARQ

Design by SEBASTIAN HERKNER



## MBARQ Setting 01

1x 00109018151	MBARQ	Daybed right, chestnut	1x 95085016815	MBRACE ALU	Seat cushion, Kvadrat® Atrium351
1x 95109217661	MBARQ	Dry+ cushion set, TWIST sand	1x 00085332151	MBRACE ALU	Footstool, chestnut
1x 00109005151	MBARQ	Left module, chestnut	1x 95085032815	MBRACE ALU	Seat cushion, Kvadrat® Atrium351
1x 95109215661	MBARQ	Cushion set, TWIST sand	1x 00933030343	IZON	Coffee table 80 x 80 cm, lipari / talc
4x 95109290815	MBARQ	Dry+ additional back cushion, Kvadrat® Atrium351	1x 00926020084	IZON	Side table Ø 54,5 cm, glass / terracotta
1x 00085306151	MBRACE ALU	Lounge chair, chestnut	1x 00101010000	LOON	Floor lamp S
			1x 00101030000	LOON	Floor lamp L

### RECOMMENDED DECO CUSHIONS:

1x 95050081815	Deco Cushion	40 x 40 cm, Kvadrat® Atrium351
1x 95050082815	Deco Cushion	50 x 50 cm, Kvadrat® Atrium351
2x 95050081481	Deco Cushion	40 x 40 cm, NATURA mandarine
1x 95050082481	Deco Cushion	50 x 50 cm, NATURA mandarine
1x 95050089661	Deco Cushion	30 x 45 cm, TWIST sand



## MBARQ Setting 02

1x 00109003115	MBARQ	Right module, pepper	1x 95073205661	DALA	Dry+ plush back cushion, TWIST sand
1x 95109215661	MBARQ	Dry+ cushion set, TWIST sand	1x 00087032117	PORCINI	Coffee table Ø 100 cm, carrara
1x 00109006115	MBARQ	Left corner module, pepper	1x 00087034117	PORCINI	Side table Ø 61 cm, carrara
1x 95109204661	MBARQ	Dry+ cushion set, TWIST sand	1x 00087036117	PORCINI	Side table Ø 51 cm, carrara
1x 00109005115	MBARQ	Left module, pepper	1x 00073062167	DALA	Lantern L, ibiza
1x 95109215661	MBARQ	Dry+ cushion set, TWIST sand	1x 00073061167	DALA	Lantern M, ibiza
9x 95109290662	MBARQ	Dry+ additional back cushion, TWIST gray	1x 00073060167	DALA	Lantern S, ibiza
1x 00073005167	DALA	Lounge chair ibiza	1x 00098030124	VID	Carpet solid 200 x 300 cm, light gray
1x 95073237661	DALA	Dry+ plush seat cushion, TWIST sand			

### RECOMMENDED DECO CUSHIONS:

2x 95050081683	Deco Cushion	40 x 40 cm, MAR ash
2x 95050081660	Deco Cushion	40 x 40 cm, TWIST beige
2x 95050084660	Deco Cushion	60 x 60 cm, TWIST beige
1x 95050082683	Deco Cushion	50 x 50 cm, MAR ash
1x 95050084683	Deco Cushion	60 x 60 cm, MAR ash



## MBARQ Setting 03

1x 00109006115	MBARQ	Left corner module, pepper	1x 00111008172	KIDA	Hanging lounge chair incl. base, dusk touch
1x 95109204682	MBARQ	Dry+ cushion set, MAR beech	1x 95111005684	KIDA	Cushion, MAR nori
1x 00109005115	MBARQ	Left module, pepper	1x 00079037205	LOU	Coffee table 68 x 170 cm, lipari / teak
1x 95109215682	MBARQ	Dry+ cushion set, MAR beech	1x 00079036205	LOU	Coffee table Ø 68 cm, lipari / teak
2x 00109035115	MBARQ	Footstool, pepper	1x 00073052167	DALA	Planter M, ibiza
2x 95109235682	MBARQ	Dry+ seat cushion, MAR beech	1x 00073061167	DALA	Lantern M, ibiza
6x 95109290647	MBARQ	Dry+ additional back cushion, LINEN flax	1x 00073060167	DALA	Lantern S, ibiza

### RECOMMENDED DECO CUSHIONS:

1x 95050081678	Deco Cushion	40 x 40 cm, Kvadrat® Patio450
1x 95050082678	Deco Cushion	50 x 50 cm, Kvadrat® Patio450
1x 95050081684	Deco Cushion	40 x 40 cm, MAR nori
1x 95050082684	Deco Cushion	50 x 50 cm, MAR nori
2x 95050081682	Deco Cushion	40 x 40 cm, MAR beech



## MBARQ Setting 04

1x 00109016141	MBARQ	3-seater high backrest, baltic	1x 95085005664	MBRACE ALU	Headrest cushion, TWIST dark turquoise
1x 95109215664	MBARQ	Dry+ cushion set, TWIST dark turquoise	1x 00937030344	IZON	Coffee table 80 x 80 cm, black pepper / lava
1x 00109015141	MBARQ	3-seater, baltic	1x 00937060344	IZON	Coffee table 50 x 90 cm, black pepper / lava
1x 95109215664	MBARQ	Dry+ cushion set, TWIST dark turquoise	1x 00929020133	IZON	Side table Ø 54,5 cm, nori / glass
6x 95109290708	MBARQ	Additional back cushion, GLAN teal	1x 00073051165	DALA	Planter L, ubud
1x 00085304141	MBRACE ALU	Wing chair, baltic	1x 00073050165	DALA	Planter S, ubud
1x 95085016664	MBRACE ALU	Seat cushion, TWIST dark turquoise	1x 00093120000	THE OTHERS	Statue, Jama

### RECOMMENDED DECO CUSHIONS:

2x 95050081676	Deco Cushion	40 x 40 cm, Kvadrat® Patio110
1x 95050081677	Deco Cushion	40 x 40 cm, Kvadrat® Patio140
1x 95050082677	Deco Cushion	50 x 50 cm, Kvadrat® Patio140
1x 95050089708	Deco Cushion	30 x 45 cm, GLAN teal
1x 95050085677	Deco Cushion	40 x 50 cm, Kvadrat® Patio140





# MBRACE

Design by SEBASTIAN HERKNER



Lounge chair, baltic | Cushion: NATURA ash



# MBRACE

Design by SEBASTIAN HERKNER

## Typology

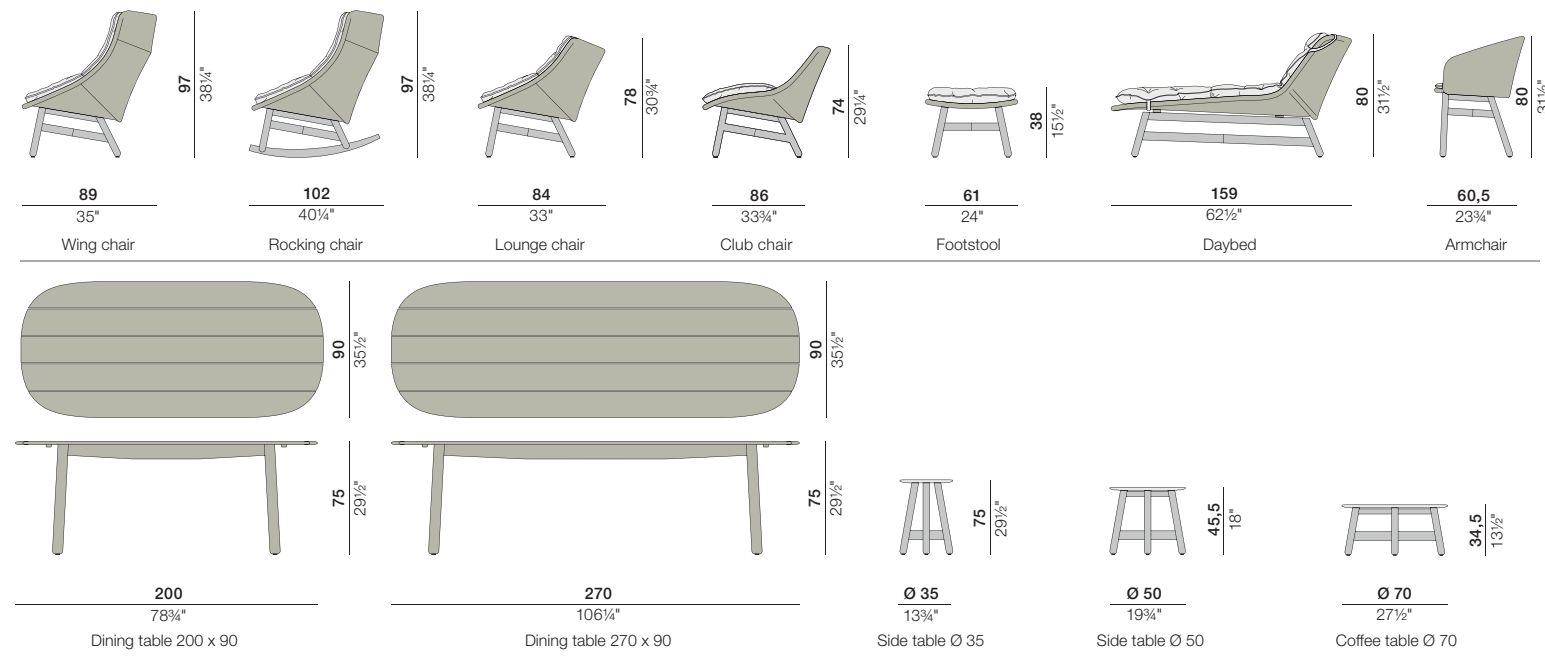

## Materials

### Fiber

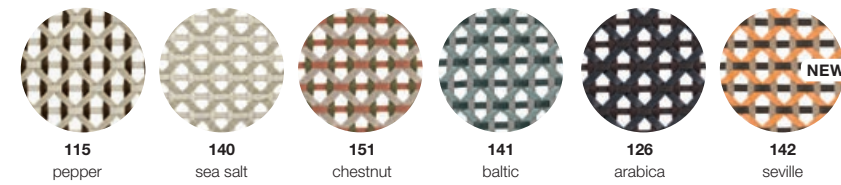

### Teak



## Fabric Information (see page 224)

Items of this collection are available in all fabrics Cat. A, B & Cat. C (only Kvadrat® Atrium).  
 Artikel dieser Kollektion sind in den Stoffen der Kat. A, B & Kat. C (nur Kvadrat® Atrium) verfügbar.

### RRP/UVF

<b>WING CHAIR</b> Hochlehner 8,6 kg 19 lbs		 97 38 1/4" 89 35" 107 42 1/4" 8 3/4" 35 13 3/4"	<b>HEADREST CUSHION</b> Nackenkissen COM 0,40 M	<b>SEAT CUSHION</b> Sitzkissen COM 1,83 M	
<b>085004</b> <b>ROCKING CHAIR</b> Schaukelstuhl 9,9 kg 22 lbs		 97 38 1/4" 102 40 1/4" 107 42 1/4" 8 3/4" 41 16 1/4"	<b>95085005</b> <b>HEADREST CUSHION</b> Nackenkissen COM 0,40 M	<b>95085016</b> <b>SEAT CUSHION</b> Sitzkissen COM 1,83 M	
<b>085008</b> <b>LOUNGE CHAIR</b> Sessel 7,5 kg 17 lbs		 78 30 3/4" 84 33" 107 42 1/4" 8 3/4" 35 13 3/4"		<b>95085016</b> <b>SEAT CUSHION</b> Sitzkissen COM 1,83 M	
<b>085006</b> <b>CLUB CHAIR</b> Club chair 6,7 kg 15 lbs		 74 29 1/4" 86 33 3/4" 83 32 3/4" 8 3/4" 35 13 3/4"		<b>95085016</b> <b>SEAT CUSHION</b> Sitzkissen COM 1,57 M	
<b>085010</b> <b>FOOTSTOOL</b> Hocker 3,8 kg 9 lbs		 45 17 3/4" 61 24" 8 3/4" 39 15 1/2"		<b>95085010</b> <b>SEAT CUSHION</b> Sitzkissen COM 0,75 M	
<b>085032</b> <b>DAYBED</b> Daybed 14,4 kg 32 lbs		 80 31 1/2" 159 62 1/2" 106 41 3/4" 8 3/4" 35 13 3/4"		<b>95085032</b> <b>CUSHION</b> Polsterauflage COM 4,20 M	
<b>085018</b> <b>CUSHION OPTION</b> Kissen Optionen		<b>95085006</b> <b>CUSHION</b> Polsterauflage COM 2,45 M		<b>95085018</b> <b>CUSHION</b> Polsterauflage COM 3,85 M	



RECOMMENDED NUMBER OF DECO CUSHIONS FOR LOUNGE, WING, ROCKING AND CLUB CHAIR WITH SEAT CUSHION.  
Empfohlene Dekokissenmenge für Sessel, Hochlehner, Schaukelstuhl und Club chair mit Sitzkissen.

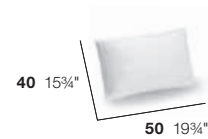

1x 95050085

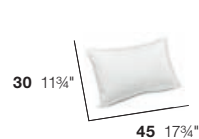

1x 95050089

COFFEE TABLE  
Kaffeetisch

Ø 70 cm  
17,2 kg  
Ø 27 1/2"  
38 lbs



300

Set: 085038300



308

Set: 085038308



341

Set: 085038341

085038



Ø 70 Ø 27 1/2"

Set: 085038308

56085039000

SIDE TABLE  
Beistelltisch

Ø 50 cm  
9,2 kg  
Ø 19 3/4"  
20 lbs



300

Set: 085036300



308

Set: 085036308



341

Set: 085036341

085036



34,5 13 1/2"

Ø 50 Ø 19 3/4"

Set: 085036308

56085037000

SIDE TABLE  
Beistelltisch

Ø 35 cm  
6,2 kg  
Ø 13 3/4"  
14 lbs



300

Set: 085034300



308

Set: 085034308



341

Set: 085034341

085034



50,5 19 3/4"

Ø 35 Ø 13 3/4"

Set: 085034308

56085035000

## Tabletops ceramic

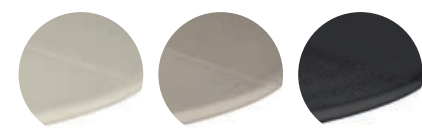

300

chalk

308

taupe

341

black

## Tabletop



205

teak

ARMCHAIR  
Armlehnstuhl

5,6 kg  
13 lbs

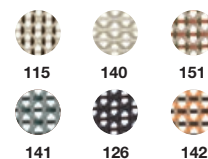

115

140

151

141

126

142



80 31 1/2"

60,5 23 3/4"

65 25 1/2"

2,5 1"

46,5 18 1/4"

62,5 24 1/2"

085001

085001115

SEAT CUSHION  
Sitzkissen

COM 0,58 M

OPTIONAL BACK CUSHION  
Optionales Rückenkissen

COM 0,47 M

95085001

95103002

DINING TABLE  
Esstisch

200 x 90 cm  
40 kg  
35 1/2" x 78 3/4"  
89 lbs



205

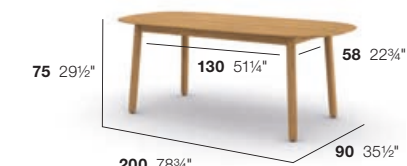

75 29 1/2"

130 51 1/4"

58 22 3/4"

200 78 3/4"

90 35 1/2"

085065

085065205

56085066000

DINING TABLE  
Esstisch

270 x 90 cm  
51 kg  
35 1/2" x 106 1/4"  
113 lbs



205

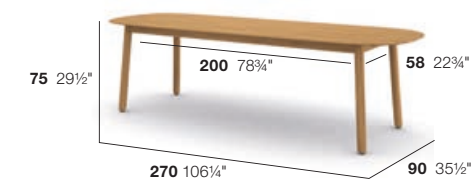

75 29 1/2"

200 78 3/4"

58 22 3/4"

270 106 1/4"

90 35 1/2"

085055

085055205

56085056000

## EN MATERIAL

The MBRACE collection comes in a mix of materials. The seats consist of DEDON Fiber woven over an aluminum frame. To clean the surface, use a soft cloth or brush, warm water and a gentle cleanser if needed. The bases and dining tables are made of premium teak. Wash using DEDON teak cleaner. To retain the golden-brown color of unweathered teak, we recommend applying DEDON teak oil at least once in every six months.

The tabletops of the side tables are made of Monolite Iperges®, a frost proof ceramic material that is non absorbing and highly resistant to indirect tensile stress, impacts, scratches and abrasion. Ceramic tabletops are handmade. This may cause variations that make each piece unique. Clean with a soft cloth and warm water. Do not cover in the winter months and ensure sufficient air circulation.

## DE MATERIAL

Die Kollektion MBRACE besteht aus einem Mix aus Materialien: Die Sitzflächen sind aus DEDON-Faser gefertigt, die über einen Aluminiumrahmen geflochten ist. Um die Oberfläche zu reinigen, benutzen Sie ein weiches Tuch oder eine weiche Bürste, warmes Wasser und, falls nötig, ein sanftes Reinigungsmittel. Die Untergestelle und Esstische sind aus hochwertigem Teakholz gefertigt. Reinigen Sie das Teakholz mit DEDON Teak Reiniger. Um den ursprünglichen goldbraunen Farbton zu bewahren, tragen Sie mindestens alle sechs Monate das DEDON Teak Öl auf.

Die Tischplatten der Beistelltische werden aus Monolite Iperges® gefertigt, einem frostsicheren, wasserabweisenden Keramikmaterial mit ausgezeichneter Kratz- und Abriebfestigkeit. Keramik-Tischplatten werden in traditioneller Handarbeit gefertigt. Dadurch können Abweichungen entstehen, die jedes Stück zu einem unverwechselbaren Unikat machen. Einfach mit einem weichen Tuch und warmem Wasser reinigen. In den Wintermonaten nicht abdecken und für ausreichend Luftzirkulation sorgen.



# MBRACE ALU

Design by SEBASTIAN HERKNER

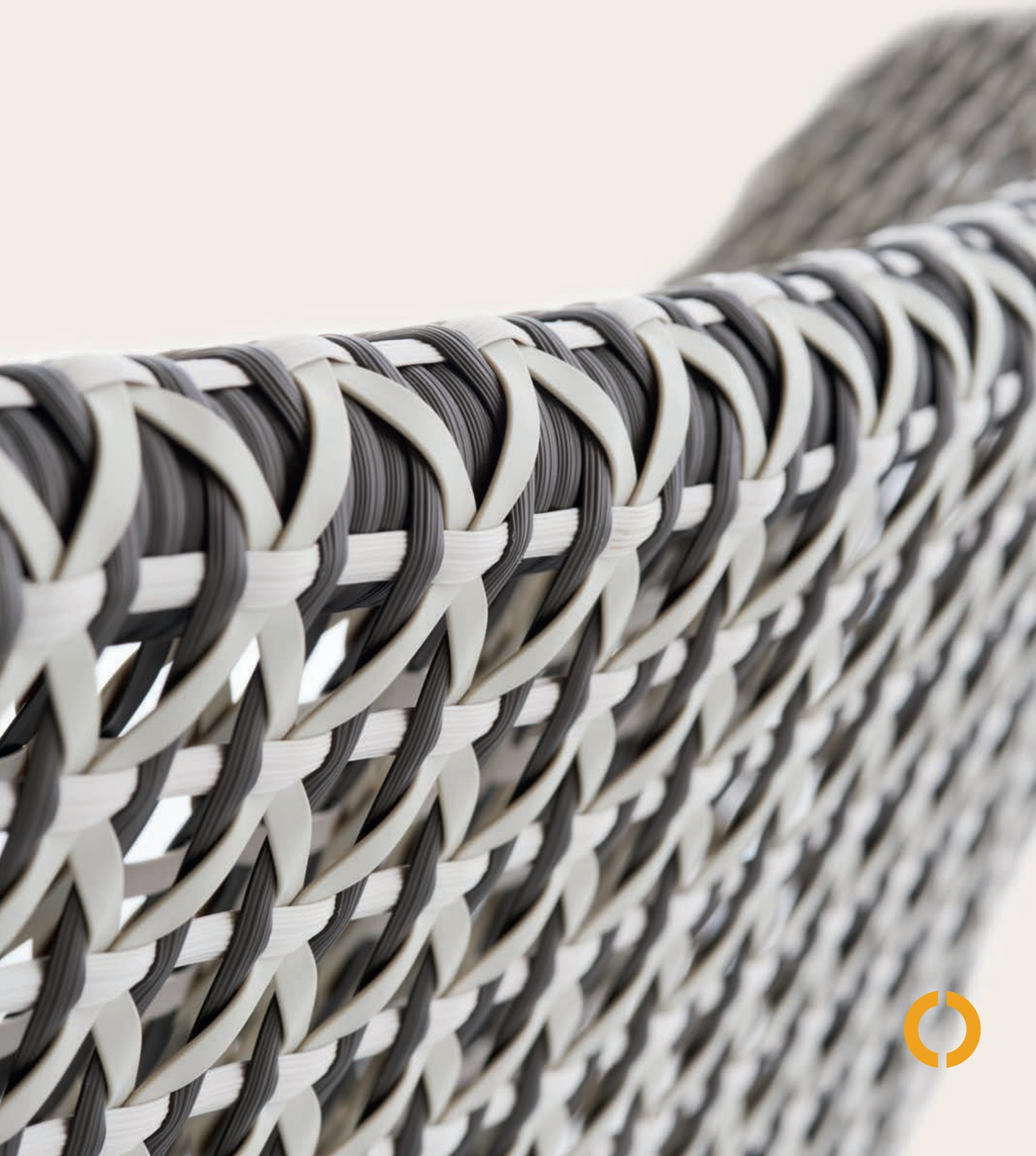

Club chair, pepper | Wing chair, pepper | Seat cushion: NATURA taupe | IZON side table Ø 54,5 cm, lipari



# MBRACE ALU

Design by SEBASTIAN HERKNER

## Typology

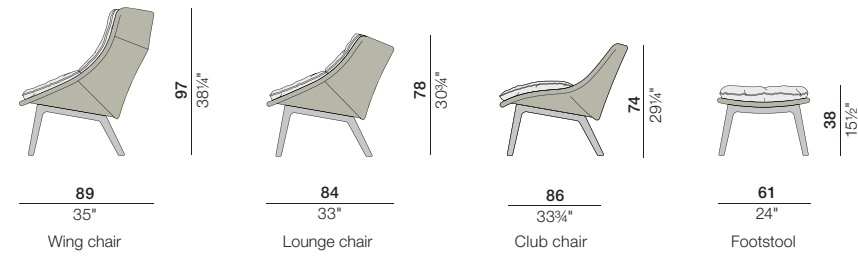

## Materials

### Alu-base combinations

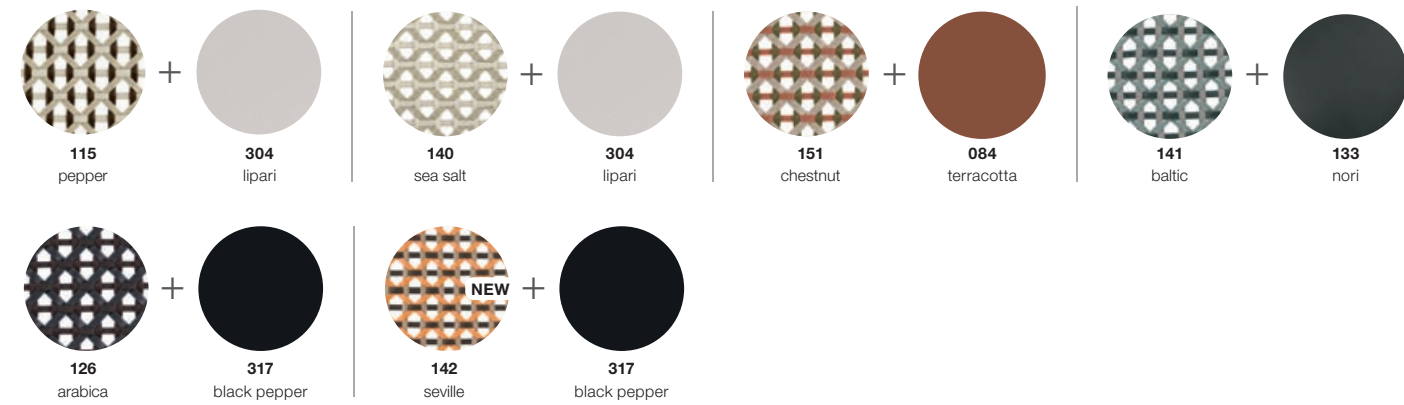

## Fabric Information (see page 224)

Items of this collection are available in all fabrics Cat. A, B & Cat. C (only Kvadrat® Atrium).  
 Artikel dieser Kollektion sind in den Stoffen der Kat. A, B & Kat. C (nur Kvadrat® Atrium) verfügbar.

RRP/UVF

WING CHAIR  
Hochlehner

13,5 kg  
30 lbs

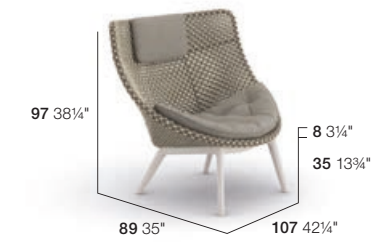
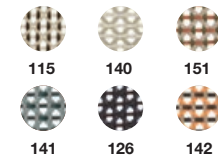

HEADREST CUSHION  
Nackenkissen  
COM 0,40 M

SEAT CUSHION  
Sitzkissen  
COM 1,83 M

085304

LOUNGE CHAIR  
Sessel

12,4 kg  
28 lbs

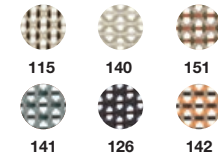

SEAT CUSHION  
Sitzkissen  
COM 1,83 M

085306

CLUB CHAIR  
Club chair

11,3 kg  
25 lbs

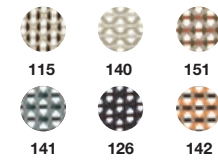

SEAT CUSHION  
Sitzkissen  
COM 1,57 M

085310

FOOTSTOOL  
Hocker

8,8 kg  
20 lbs

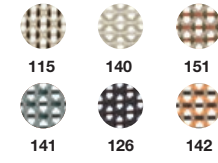

SEAT CUSHION  
Sitzkissen  
COM 0,75 M

085332

CUSHION OPTION  
Kissen Optionen



CUSHION  
Polsterauflage  
COM 2,45 M

CUSHION  
Polsterauflage  
COM 3,85 M

RECOMMENDED NUMBER OF DECO CUSHIONS FOR LOUNGE, WING AND CLUB CHAIR WITH SEAT CUSHION.  
 Empfohlene Dekokissenmenge für Sessel, Hochlehner und Club chair mit Sitzkissen.

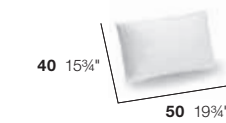

1x 95050085



1x 95050089

### EN MATERIAL

The seats of the MBRACE ALU collection consist of DEDON fiber woven over a powder coated aluminum frame. To clean the surface, use a soft cloth or brush, warm water and a gentle cleanser if needed. The bases are made of a powder coated, die cast, single-piece aluminum base. Clean with a soft cloth and warm water.

### DE MATERIAL

Die Sitzflächen der MBRACE ALU Kollektion sind aus DEDON Faser gefertigt, die auf einen Aluminiumrahmen geflochten ist. Um die Oberfläche zu reinigen, benutzen Sie ein weiches Tuch oder eine weiche Bürste, warmes Wasser und, falls nötig, ein sanftes Reinigungsmittel. Die Untergestelle bestehen aus pulverbeschichtetem, in einem Stück druckgegossenem Aluminium. Einfach mit einem weichen Tuch und warmem Wasser reinigen.



# MBRACE DINING

Design by SEBASTIAN HERKNER



MBRACE Dining Setting 01

- 4x 00085001141 MBRACE Armchair, baltic
- 4x 95085001478 MBRACE Seat cushion, NATURA ash
- 4x 95103002478 MBRACE Optional back cushion, NATURA ash
- 1x 00089085205 TIBBO Dining table Ø 150 cm, teak



MBRACE Dining Setting 02

- 6x 00085001115 MBRACE Armchair, pepper
- 6x 95085001472 MBRACE Seat cushion, NATURA taupe
- 1x 00085055205 MBRACE Dining table 270 x 90 cm, teak
- 1x 00098025125 VID Carpet solid 300 x 400 cm, canvas
- 1x 00073051167 DALA Planter L, ibiza
- 1x 00073050167 DALA Planter S, ibiza
- 1x 00073062167 DALA Lantern L, ibiza



MBRACE Dining Setting 03

- 8x 00085001140 MBRACE Armchair, sea salt
- 8x 95085001675 MBRACE Seat cushion, Kvadrat® Patio220
- 1x 00089055205 TIBBO Dining table 103 x 278 cm, teak



MBRACE Dining Setting 04

- 4x 00085001126 MBRACE Armchair, arabica
- 4x 95085001662 MBRACE Seat cushion, TWIST gray
- 1x 00707076205 SEAX Dining table 100 x 100 cm, black pepper/teak



# MBRACE

Design by SEBASTIAN HERKNER



MBRACE Setting 01

- 1x **00085306142** MBRACE ALU Lounge chair, seville
- 1x **95085016651** MBRACE ALU Seat cushion, LINEN sand
- 1x **00085304142** MBRACE ALU Wing chair, seville
- 1x **95085016651** MBRACE ALU Seat cushion, LINEN sand
- 1x **00085332142** MBRACE ALU Footstool, seville
- 1x **95085032651** MBRACE ALU Seat cushion, LINEN sand

- 1x **00917020317** IZON Side table Ø 54,5 cm, black pepper/HPL
- 1x **00073052166** DALA Planter M, cuba
- 1x **00073050166** DALA Planter S, cuba
- 1x **00073062164** DALA Lantern L, rioja
- 1x **00073061164** DALA Lantern M, rioja
- 1x **00073060164** DALA Lantern S, rioja

RECOMMENDED DECO CUSHIONS:

- 1x **95050089481** Deco cushion 30 x 45 cm, NATURA mandarine
- 2x **95050085477** Deco cushion 50 x 40 cm, NATURA garnet
- 1x **95050082481** Deco cushion 50 x 50 cm, NATURA mandarine



MBRACE Setting 02

- 1x **00085006141** MBRACE Lounge chair, baltic
- 1x **95085006677** MBRACE Cushion, Kvadrat® Patio140
- 1x **00085004141** MBRACE Wing chair, baltic
- 1x **95085016677** MBRACE Seat cushion, Kvadrat® Patio140
- 1x **00085008141** MBRACE Rocking chair, baltic
- 1x **95085016677** MBRACE Seat cushion, Kvadrat® Patio140
- 1x **95085005677** MBRACE Headrest cushion, Kvadrat® Patio140
- 1x **00085032141** MBRACE Footstool, baltic

- 1x **00085038308** MBRACE Coffee table Ø 70 cm, taupe
- 1x **00085036300** MBRACE Side table Ø 50 cm, chalk
- 1x **00085034300** MBRACE Side table Ø 35 cm, chalk
- 1x **00101030000** LOON Floor lamp L
- 1x **00101010000** LOON Floor lamp S
- 1x **00098020124** VID Carpet solid 200 x 300 cm, light gray
- 1x **00098030124** VID Carpet fringes 200 x 300 cm, light gray

RECOMMENDED DECO CUSHIONS:

- 1x **95050081681** Deco cushion 40 x 40 cm, Kvadrat® Patio970
- 1x **95050081664** Deco cushion 40 x 40 cm, TWIST dark turquoise
- 1x **95050082677** Deco cushion 50 x 50 cm, Kvadrat® Patio140
- 1x **95050089681** Deco cushion 30 x 45 cm, Kvadrat® Patio970



MBRACE Setting 03

- 2x **00085008115** MBRACE Rocking Chair, pepper
- 1x **95085016661** MBRACE Seat cushion, TWIST sand
- 1x **95085005661** MBRACE Headrest cushion, TWIST sand
- 1x **95085004661** MBRACE Cushion, TWIST sand
- 2x **00085032115** MBRACE Footstool, pepper
- 2x **95085032661** MBRACE Seat cushion, TWIST sand

- 1x **00085018115** MBRACE Daybed, pepper
- 1x **95085018661** MBRACE Cushion, TWIST sand
- 1x **00087036116** PORCINI Side table Ø 51 cm, marrone
- 1x **00087038116** PORCINI Side table Ø 41 cm, marrone
- 1x **00101030000** LOON Floor lamp L
- 1x **00101010000** LOON Floor lamp S

RECOMMENDED DECO CUSHIONS:

- 2x **95050085475** Deco cushion 40 x 50 cm, NATURA marengo
- 1x **95050081475** Deco cushion 40 x 40 cm, NATURA marengo



MBRACE Setting 04

- 2x **00085310151** MBRACE ALU Club chair, chestnut
- 2x **95085010651** MBRACE ALU Seat cushion, LINEN sand
- 1x **00109016151** MBARQ 3-Seater, high backrest, chestnut
- 1x **95109215651** MBARQ Dry+ cushion set, LINEN sand
- 3x **95109290472** MBARQ Dry+ additional back cushion, NATURA taupe

- 1x **00933070343** IZON Coffee table 50 x 130 cm, talc
- 1x **00926020084** IZON Coffee table Ø 54,5 cm, terracotta/glass terracotta
- 1x **00073051167** DALA Planter L, ibiza
- 1x **00073050167** DALA Planter S, ibiza

RECOMMENDED DECO CUSHIONS:

- 2x **95050089472** Deco cushion 30 x 45 cm, NATURA taupe
- 3x **95050081815** Deco cushion 40 x 40 cm, Kvadrat® Atrium351
- 1x **95050082650** Deco cushion 50 x 50 cm, LINEN off white





# MU

Design by TOAN NGUYEN



Right module XXL, vulcano | Daybed left, vulcano | Cushion: NATURA taupe | Coffee table 90 x 90 cm, HPL





# MU

Design by TOAN NGUYEN

## Typology

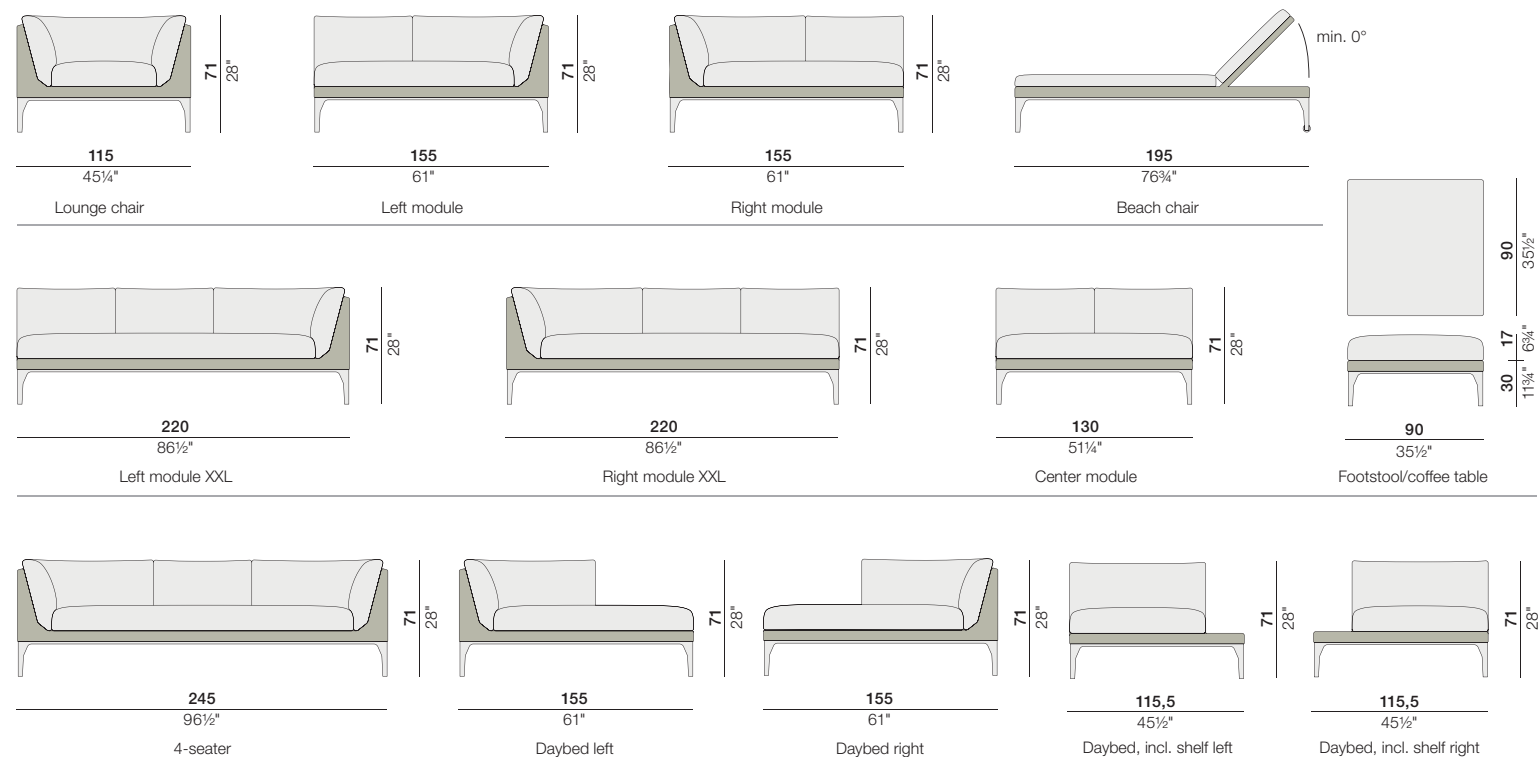

## Materials

### Combinations



## Fabric Information (see page 224)

Cushions for this collection are available in all fabrics Cat. A, B, C.  
Kissen für diese Kollektion sind in allen Stoffen der Kat. A, B, C verfügbar.

RRP/UVF

LOUNGE CHAIR  
Sessel

28 kg  
62 lbs



DRY+ SEAT CUSHION + DRY+ BACK CUSHION  
Dry+ Sitzkissen + Dry+ Rückenkissen  
COM 4,03 M



067001

LEFT MODULE  
Modul links

29 kg  
64 lbs



DRY+ SEAT CUSHION + DRY+ BACK CUSHION  
Dry+ Sitzkissen + Dry+ Rückenkissen  
COM 4,36 M



067005

RIGHT MODULE  
Modul rechts

29 kg  
64 lbs



DRY+ SEAT CUSHION + DRY+ BACK CUSHION  
Dry+ Sitzkissen + Dry+ Rückenkissen  
COM 4,36 M



067003

LEFT MODULE XXL  
Modul links XXL

35 kg  
78 lbs



DRY+ SEAT CUSHION + DRY+ BACK CUSHION  
Dry+ Sitzkissen + Dry+ Rückenkissen  
COM 5,79 M



067006

RIGHT MODULE XXL  
Modul rechts XXL

35 kg  
78 lbs



DRY+ SEAT CUSHION + DRY+ BACK CUSHION  
Dry+ Sitzkissen + Dry+ Rückenkissen  
COM 5,79 M

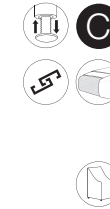

067004

CENTER MODULE  
Modul mitte

24 kg  
53 lbs



DRY+ SEAT CUSHION + DRY+ BACK CUSHION  
Dry+ Sitzkissen + Dry+ Rückenkissen  
COM 3,28 M

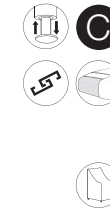

067011

4-SEATER  
4er-Sofa

39 kg  
86 lbs



DRY+ SEAT CUSHION + DRY+ BACK CUSHION  
Dry+ Sitzkissen + Dry+ Rückenkissen  
COM 4,63 M



067015

Set 95067215 56067015000



RRP/UVP  
 DAYBED LEFT  
 Daybed links

28,5 kg  
 63 lbs

111  
 099



067017  
 067017099

Set 95067217 56067017000

DRY+ SEAT CUSHION + DRY+ BACK CUSHION  
 Dry+ Sitzkissen + Dry+ Rückenkissen

COM 4,97 M

DAYBED RIGHT  
 Daybed rechts

28,5 kg  
 63 lbs

111  
 099



067018  
 067018099

Set 95067218 56067018000

DRY+ SEAT CUSHION + DRY+ BACK CUSHION  
 Dry+ Sitzkissen + Dry+ Rückenkissen

COM 4,97 M

DAYBED, INCL. SHELF LEFT  
 Daybed, inkl. Ablage links

36,4 kg  
 81 lbs

111 + 306  
 099 + 317



067124  
 067124099

Set 95067224 56067024000

DRY+ SEAT CUSHION + DRY+ BACK CUSHION  
 Dry+ Sitzkissen + Dry+ Rückenkissen

COM 3,58 M

DAYBED, INCL. SHELF RIGHT  
 Daybed, inkl. Ablage rechts

36,4 kg  
 81 lbs

111 + 306  
 099 + 317



067125  
 067125099

Set 95067224 56067025000

DRY+ SEAT CUSHION + DRY+ BACK CUSHION  
 Dry+ Sitzkissen + Dry+ Rückenkissen

COM 3,58 M

FOOTSTOOL  
 Hocker

90 x 90 cm  
 18 kg  
 35 1/2" x 35 1/2"  
 40 lbs

111  
 099

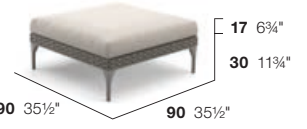

067016  
 067016099

Set 95067216 56067030000

DRY+ SEAT CUSHION  
 Dry+ Sitzkissen

COM 1,73 M

COFFEE TABLE  
 Kaffeetisch

90 x 90 cm  
 24,6 kg  
 35 1/2" x 35 1/2"  
 55 lbs

111 + 306  
 099 + 317



067116  
 Set: 067116099

Set: 067116111 56067016000

COFFEE TABLE  
 Kaffeetisch

90 x 90 cm  
 31,5 kg  
 35 1/2" x 35 1/2"  
 70 lbs

111 + 304  
 099 + 099



067216  
 Set: 067216099

Set: 067216111 56067016000

RRP/UVP  
 BEACH CHAIR  
 WITH GAS SPRING  
 Sonnenliege  
 mit Gasdruckfeder

28,5 kg  
 63 lbs

111  
 099



067019  
 067019099

Set 95067219 56067019000

DRY+ CUSHION  
 Dry+ Kissen

COM 2,47 M

RECOMMENDED DECO CUSHIONS  
 Empfohlene Dekokissen



95050082 95050081

**EN MATERIAL**  
 MU furniture consist of DEDON fiber woven over a powder coated aluminum frame. The seat is made of Tensiline® fabric. To clean the surface, use a soft cloth or brush, warm water and a gentle cleanser if needed.  
 To clean the glass or HPL tabletops, use a soft cloth, warm water and a gentle cleanser if needed.

**DE MATERIAL**  
 Die Möbel der MU Kollektion bestehen aus DEDON-Faser, die auf einem pulverbeschichteten Aluminiumrahmen geflochten ist. Die Sitzfläche besteht aus Tensiline® Stoff. Um die Oberfläche zu reinigen, benutzen Sie ein weiches Tuch oder eine weiche Bürste, warmes Wasser und, falls nötig, ein sanftes Reinigungsmittel.  
 Zur Reinigung der wahlweise aus Glas oder HPL bestehenden Tischplatten eignen sich ein weiches Tuch, warmes Wasser und bei Bedarf ein sanftes Reinigungsmittel.



# MU

Design by TOAN NGUYEN



MU Setting 01

- 1x **00067004099** MU Right module XXL, vulcano
- 1x **95067204472** MU Dry+ cushion set, NATURA taupe
- 1x **00067124099** MU Daybed, incl. shelf left, vulcano
- 1x **95067224472** MU Dry+ cushion set, NATURA taupe
- 1x **00067116099** MU Coffee table 90 x 90 cm, HPL / vulcano

- 1x **00053084300** BABYLON Planter L, chalk
- 1x **00053112000** BABYLON Stool / side table PE, incl. light, off white

RECOMMENDED DECO CUSHIONS:

- 1x **95050081478** Deco cushion 40 x 40 cm, NATURA ash
- 1x **95050081475** Deco cushion 40 x 40 cm, NATURA marengo
- 2x **95050082474** Deco cushion 50 x 50 cm, NATURA dark gray
- 1x **95050084478** Deco cushion 60 x 60 cm, NATURA ash



MU Setting 02

- 1x **00067003111** MU Right module, accona
- 1x **95067203480** MU Dry+ cushion set, NATURA laurel
- 1x **00067005111** MU Left module, accona
- 1x **95067205480** MU Dry+ cushion set, NATURA laurel
- 1x **00067006111** MU Left module XXL, accona
- 1x **95067206480** MU Dry+ cushion set, NATURA laurel
- 1x **00079034205** LOU Coffee table Ø 102 cm, lipari / teak

- 2x **00073005167** DALA Lounge chair, ibiza
- 2x **95073237472** DALA Dry+ plush seat cushion, NATURA taupe
- 2x **95073205472** DALA Dry+ plush back cushion, NATURA taupe
- 1x **00073036167** DALA Side table Ø 46 cm, ibiza
- 1x **00073062167** DALA Lantern L, ibiza
- 2x **00073061167** DALA Lantern M, ibiza
- 1x **00073060167** DALA Lantern S, ibiza
- 2x **00098030124** VID Carpet fringes 200 x 300 cm, light gray

RECOMMENDED DECO CUSHIONS:

- 1x **95050081472** Deco cushion 40 x 40 cm, NATURA taupe
- 2x **95050082480** Deco cushion 50 x 50 cm, NATURA laurel
- 2x **95050084479** Deco cushion 60 x 60 cm, NATURA pomelo
- 1x **95050086472** Deco cushion 70 x 70 cm, NATURA taupe



MU Setting 03

- 1x **00067006111** MU Left module XXL, accona
- 1x **95067206816** MU Dry+ cushion set, Kvadrat® AtriumD11
- 1x **00067005111** MU Left module, accona
- 1x **95067205816** MU Dry+ cushion set, Kvadrat® AtriumD11
- 1x **00067016111** MU Footstool 90 x 90 cm, accona
- 1x **95067216816** MU Dry+ seat cushion, Kvadrat® AtriumD11
- 1x **00087032147** PORCINI Coffee table Ø 100 cm, alba

- 1x **00087036147** PORCINI Side table Ø 51 cm, alba
- 1x **00087038147** PORCINI Side table Ø 41 cm, alba
- 2x **00085306115** MBRACE ALU Lounge chair, pepper
- 2x **95085016476** MBRACE Seat cushion, NATURA marsala
- 1x **00093020129** THE OTHERS Lantern M, terra
- 1x **00093030130** THE OTHERS Lantern L, rock

RECOMMENDED DECO CUSHIONS:

- 4x **95050081685** Deco cushion 40 x 40 cm, MAR terracotta
- 1x **95050082663** Deco cushion 50 x 50 cm, TWIST terracotta
- 1x **95050082472** Deco cushion 50 x 50 cm, NATURA taupe
- 1x **95050084663** Deco cushion 60 x 60 cm, TWIST terracotta
- 2x **95050081663** Deco cushion 40 x 40 cm, TWIST terracotta



MU Setting 04

- 1x **00067001111** MU Lounge chair, accona
- 1x **95067201478** MU Dry+ cushion set, NATURA ash
- 1x **00067015111** MU 4-seater, accona
- 1x **95067215478** MU Dry+ cushion set, NATURA ash
- 1x **00067005111** MU Left module, accona
- 1x **95067205478** MU Dry+ cushion set, NATURA ash
- 1x **00067011111** MU Center module, accona
- 1x **95067211478** MU Dry+ cushion set, NATURA ash
- 1x **00067018111** MU Daybed right, accona

- 1x **95067218478** MU Dry+ cushion set, NATURA ash
- 1x **00067216111** MU Coffee table 90 x 90 cm, glass / accona
- 1x **00933040343** IZON Coffee table 120 x 120 cm, lipari / talc
- 1x **00933070343** IZON Coffee table 50 x 130 cm, lipari / talc
- 1x **00073062168** DALA Lantern L, bahamas
- 1x **00073061168** DALA Lantern M, bahamas
- 1x **00073061166** DALA Lantern M, cuba
- 1x **00073060166** DALA Lantern S, cuba

RECOMMENDED DECO CUSHIONS:

- 2x **95050081685** Deco cushion 40 x 40 cm, MAR terracotta
- 1x **95050081815** Deco cushion 40 x 40 cm, Kvadrat® Atrium351
- 1x **95050082815** Deco cushion 50 x 50 cm, Kvadrat® Atrium351
- 2x **95050081684** Deco cushion 40 x 40 cm, MAR nori
- 1x **95050082813** Deco cushion 50 x 50 cm, Kvadrat® Atrium781
- 1x **95050082684** Deco cushion 50 x 50 cm, MAR nori
- 1x **95050084813** Deco cushion 60 x 60 cm, Kvadrat® Atrium781





# NESTREST

Design by DANIEL POUZET & FRED FRETÉ



Standing lounger, chalk | Hanging lounger, natural | Hanging lounger, olive | Cushion: NATURA white



# NESTREST

Design by DANIEL POUZET & FRED FRETY

## Typology

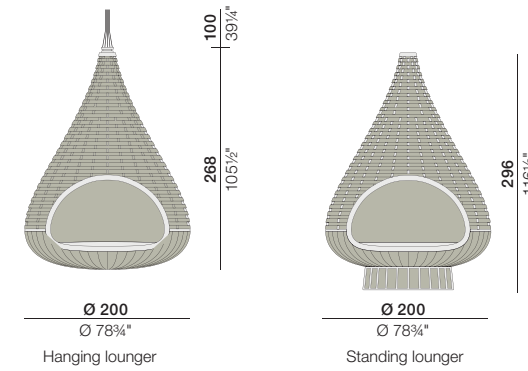

## Materials

### Combinations

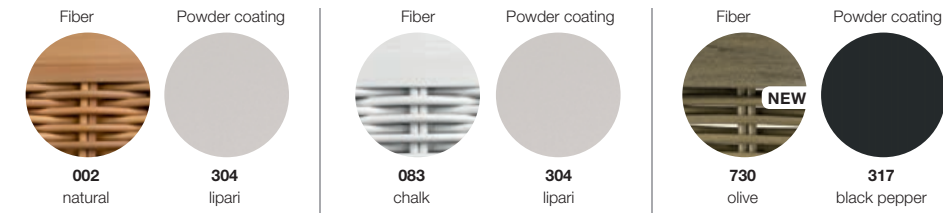

## Fabric Information (see page 224)

Items of this collection are available in all fabrics Cat. A, B & Cat. C (only Kvadrat® Atrium).  
 Artikel dieser Kollektion sind in den Stoffen der Kat. A, B & Kat. C (nur Kvadrat® Atrium) verfügbar.

RRP/UVF

HANGING LOUNGER  
 Hanging lounger

Ø 200 cm  
 85,5 kg  
 Ø 78 3/4" \*  
 189 lbs

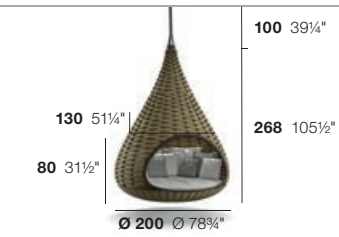

SEAT CUSHION  
 Sitzkissen  
 COM 7,25 M



090919

STANDING LOUNGER, INCL. BASE  
 Standing lounger, inkl. Untersatz

Ø 200 cm  
 99,5 kg  
 Ø 78 3/4" \*  
 220 lbs

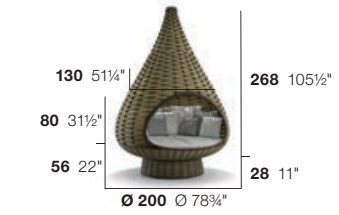

SEAT CUSHION  
 Sitzkissen  
 COM 7,25 M



090023

BASE, SUITABLE FOR HANGING AND STANDING LOUNGER  
 Untersatz, passend für Hanging und Standing lounger

14 kg  
 31 lbs



95090219

6600000863

090018

TETHERING ROPE  
 Bodenbefestigung

1,4 kg  
 3,5 lbs



23091005009

RECOMMENDED BACK CUSHION  
 Empfohlene Rückenkissenmenge

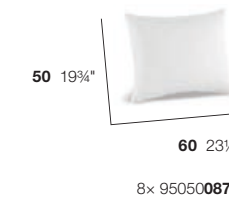

RECOMMENDED DECO CUSHION  
 Empfohlene Dekokissenmenge

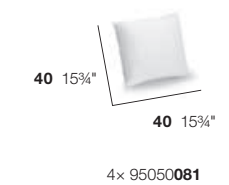

EN ATTENTION

Hanging and standing lounger do not fit through standard doors!  
 Weight capacity: 350 kg/770 lbs.

COVERS

Cover is tailored to protect seat and deco cushions only.

MATERIAL

NESTREST furniture consist of DEDON fiber woven over a powder coated aluminum frame. To clean the surface, use a soft cloth or brush, warm water and a gentle cleanser if needed.

DE ACHTUNG

Hanging und Standing Lounger passen nicht durch Türen mit Standardabmessungen!  
 Tragkraft: 350 kg/770 lbs.

HUSSEN

Die Husse dient nur zum Schutz der Sitzfläche und der Dekokissen.

MATERIAL

Die Möbel der NESTREST Kollektion bestehen aus DEDON-Faser, die auf einen pulverbeschichteten Aluminiumrahmen geflochten ist. Um die Oberfläche zu reinigen, benutzen Sie ein weiches Tuch oder eine weiche Bürste, warmes Wasser und, falls nötig, ein sanftes Reinigungsmittel.

EN The NESTREST is shipped with pre-mounted handles.



DE Das NESTREST wird inkl. vormontierter Griffe geliefert.

For more NESTREST products see page 192







# ORBIT

Design by RICHARD FRINIER



Loveseat XXL, vulcano | Canopy: taupe | Cushion: NATURA dark gray

# ORBIT

Design by RICHARD FRINIER

## Typology

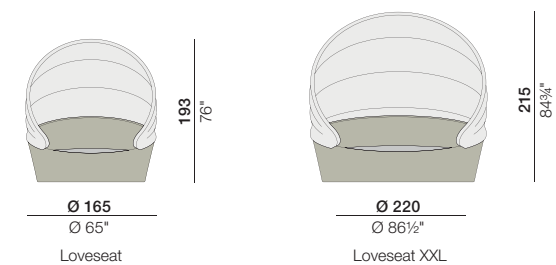

## Materials

### Fiber

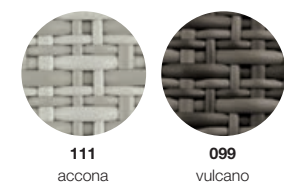

## Fabric Information (see page 224)

Items of this collection are available in all fabrics Cat. A, B & Cat. C (only Kvadrat® Atrium).  
 Artikel dieser Kollektion sind in den Stoffen der Kat. A, B & Kat. C (nur Kvadrat® Atrium) verfügbar.

RRP/UDP

LOVESEAT  
Sofainset

Ø 165 cm  
Ø 65"

42,5 kg  
94 lbs



193 76"



Ø 165 Ø 65"

030008111

6 2¼"  
37 14½"



030008099

SEAT CUSHION  
Sitzkissen

COM 3,26 M



030018111



030018099

95030001



LOVESEAT XXL  
Sofainset XXL

Ø 220 cm  
Ø 86½"

69 kg  
153 lbs



215 84¾"



Ø 220 Ø 86½"

030011111

13 5"  
40 15¾"



030011099

SEAT CUSHION  
Sitzkissen

COM 6,30 M



030111111



030111099

95030004

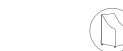

RECOMMENDED NUMBER OF DECO CUSHIONS  
Empfohlene Dekokissenmenge



70 27½"

70 27½"

4x 95050086

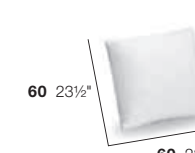

60 23½"

60 23½"

4x 95050084

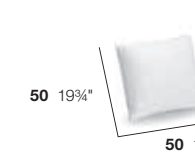

50 19¾"

50 19¾"

2x 95050082

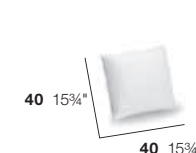

40 15¾"

40 15¾"

2x 95050081

### EN MATERIAL

ORBIT furniture consist of DEDON fiber woven over a powder coated aluminum frame. The seat is made of tensiline® fabric. To clean the surface, use a soft cloth or brush, warm water and a gentle cleanser if needed.

The ORBIT canopy can be washed with lukewarm water and mild cleaning agents. Use a sponge or a soft brush to wipe the material. The canopy may not be machine washed, as this could affect the impregnation, thus making the material more susceptible to dirt. Always make sure that the canopy is completely dry before you fold it together again to avoid permanent stains.

### DE MATERIAL

Die Möbel der ORBIT Kollektion bestehen aus DEDON-Faser, die auf einem pulverbeschichteten Aluminiumrahmen geflochten ist. Die Sitzfläche besteht aus Tensiline® Stoff. Um die Oberfläche zu reinigen, benutzen Sie ein weiches Tuch oder eine weiche Bürste, warmes Wasser und, falls nötig, ein sanftes Reinigungsmittel.

Das ORBIT Verdeck kann mit lauwarmem Wasser und milden Reinigungsmitteln gewaschen werden. Zur Reinigung eignet sich ein Schwamm oder eine weiche Bürste. Das Verdeck muss hierzu voll aufgespannt werden. Um die Imprägnierung des Materials zu bewahren, waschen Sie das Verdeck niemals in der Waschmaschine. Achten Sie darauf, dass das ORBIT Verdeck vollständig getrocknet ist, bevor Sie es wieder zusammen falten um bleibende Flecken zu vermeiden.

EN The loveseat / loveseat XXL is shipped with pre-mounted pullout casters.

DE Die Sofainset / Sofainset XXL wird inkl. vormontierter ausklappbarer Räder geliefert.





# PANAMA

Design by RICHARD FRINIER



Armchair, bronze | Side chair, bronze | Cushion: TWIST gray

# PANAMA

Design by RICHARD FRINIER

## Typology

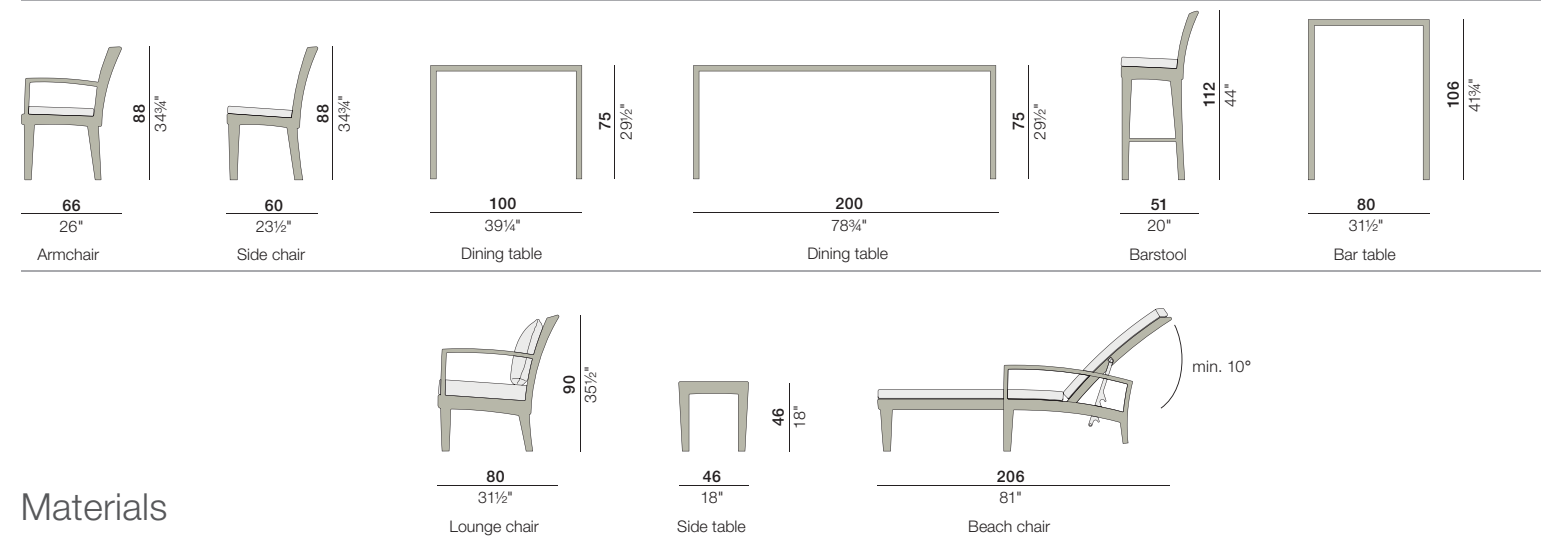

## Materials



## Fabric Information (see page 224)

Items of this collection are available in all fabrics Cat. A, B & Cat. C (only Kvadrat® Atrium).  
Artikel dieser Kollektion sind in den Stoffen der Kat. A, B & Kat. C (nur Kvadrat® Atrium) verfügbar.

RRP/UVF	Color	Item	Weight	Dimensions	Accessories	Code
022003	040	SIDE CHAIR Esststuhl	5 kg 12 lbs	88 34 3/4" x 60 23 1/2" x 48 19"	SEAT CUSHION Sitzkissen COM 0,71 M	95022003 56022003000
022001	040	ARMCHAIR Armlehnstuhl	7 kg 16 lbs	88 34 3/4" x 66 26" x 60 23 1/2"	SEAT CUSHION Sitzkissen COM 0,67 M	95022001 56022001000

RRP/UVF	Color	Item	Weight	Dimensions	Accessories	Code
222270	040 + 000	DINING TABLE Esstisch	25 kg 39 1/4" x 39 1/4"	100 39 1/4" x 100 39 1/4" x 75 29 1/2"		Set: 222270040 5602706000
222120	040 + 000	DINING TABLE Esstisch	44 kg 39 1/4" x 78 3/4"	200 78 3/4" x 100 39 1/4" x 75 29 1/2"		Set: 222120040 5602706000
222450	040 + 000	BAR TABLE Bartisch	15,3 kg 31 1/2" x 31 1/2"	80 31 1/2" x 80 31 1/2" x 106 41 3/4"		Set: 222450040 56039061000
022029	040	BARSTOOL Barhocker	6 kg 13 lbs	112 44" x 51 20" x 49 19 1/4"	SEAT CUSHION Sitzkissen COM 0,66 M	95022028 56022028000
022005	040	LOUNGE CHAIR Sessel	8 kg 18 lbs	90 35 1/2" x 80 31 1/2" x 73 28 3/4"	SEAT CUSHION + BACK CUSHION Sitzkissen + Rückenkissen COM 1,61 M	Set 95022005 56022005000
022034	040 + 000	SIDE TABLE Beistelltisch	7 kg 18" x 18"	46 18" x 46 18" x 46 18"		Set: 022034040 56022033000
022020	040	BEACH CHAIR WITH HOOK-CATCHING Sonnenliege mit Stufenverstellung	16 kg 36 lbs	206 81" x 78 30 3/4" x 56 22" (min. 10°)	CUSHION Kissen COM 2,65 M	95022019 56022019000





# PAROS

Design by JEAN-MARIE MASSAUD



3-seater | Cushion: LINEN off white





# PAROS

Design by JEAN-MARIE MASSAUD

## Typology

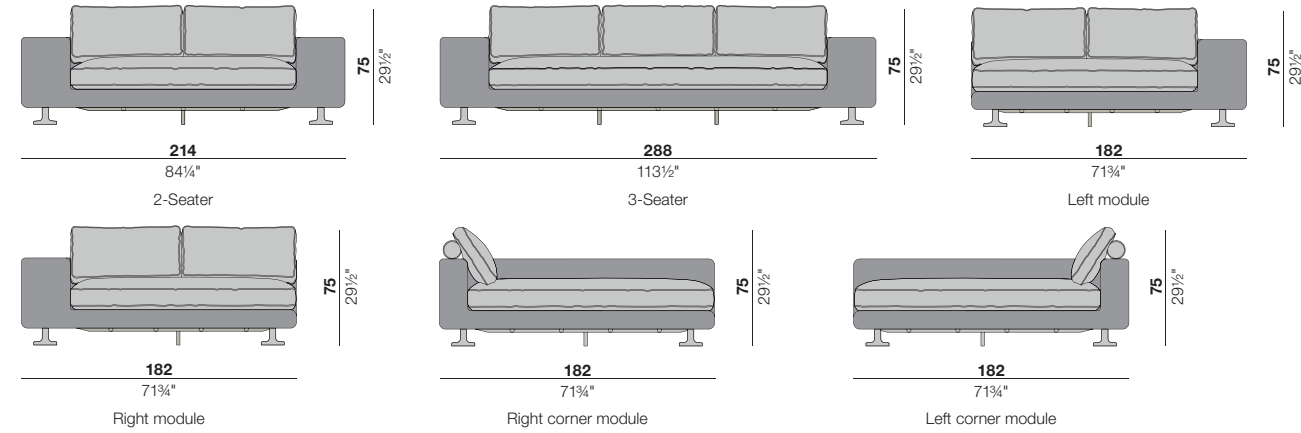

## Materials

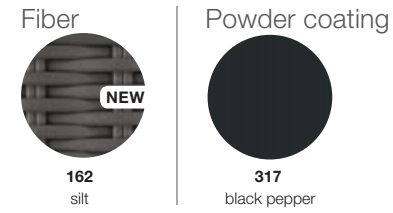

## Fabric Information (see page 224)

Cushions for this collection are available in all fabrics Cat. A, B, C.  
Kissen für diese Kollektion sind in allen Stoffen der Kat. A, B, C verfügbar.

RRP/UVP						
2-SEATER 2er Sofa 58,5 kg 129 lbs			DRY+ PLUSH CUSHION SET INCL. ROLL Dry+ Plush Kissen Set inkl. Rolle COM 3,75 M	ADDITIONAL SIDE CUSHION Zusätzliches Seitenkissen COM 0,6 M		
<b>113012</b>		113012 <b>162</b>	<b>95113212</b>	<b>95113297</b>	<b>56113012000</b>	
3-SEATER 3er Sofa 77,5 kg 171 lbs			DRY+ PLUSH CUSHION SET INCL. ROLL Dry+ Plush Kissen Set inkl. Rolle COM 5,5 M	ADDITIONAL SIDE CUSHION Zusätzliches Seitenkissen COM 0,6 M		
<b>113015</b>		113015 <b>162</b>	<b>95113215</b>	<b>95113297</b>	<b>56113015000</b>	

RRP/UVP						
LEFT MODULE Modul links 50 kg 111 lbs			DRY+ PLUSH CUSHION SET INCL. ROLL Dry+ Plush Kissen Set inkl. Rolle COM 3,75 M	ADDITIONAL SIDE CUSHION Zusätzliches Seitenkissen COM 0,6 M		
<b>113005</b>		113005 <b>162</b>	<b>95113212</b>	<b>95113297</b>	<b>56113005000</b>	
RIGHT MODULE Modul rechts 50 kg 111 lbs			DRY+ PLUSH CUSHION SET INCL. ROLL Dry+ Plush Kissen Set inkl. Rolle COM 3,75 M	ADDITIONAL SIDE CUSHION Zusätzliches Seitenkissen COM 0,6 M		
<b>113003</b>		113003 <b>162</b>	<b>95113212</b>	<b>95113297</b>	<b>56113003000</b>	
LEFT CORNER MODULE Eckmodul links 49,5 kg 110 lbs			DRY+ PLUSH CUSHION SET INCL. ROLL Dry+ Plush Kissen Set inkl. Rolle COM 2,9 M	ADDITIONAL SIDE CUSHION Zusätzliches Seitenkissen COM 0,6 M		
<b>113006</b>		113006 <b>162</b>	<b>95113204</b>	<b>95113297</b>	<b>56113006000</b>	
RIGHT CORNER MODULE Eckmodul rechts 49,5 kg 110 lbs			DRY+ PLUSH CUSHION SET INCL. ROLL Dry+ Plush Kissen Set inkl. Rolle COM 2,9 M	ADDITIONAL SIDE CUSHION Zusätzliches Seitenkissen COM 0,6 M		
<b>113004</b>		113004 <b>162</b>	<b>95113204</b>	<b>95113297</b>	<b>56113004000</b>	
<b>EN MATERIAL</b> PAROS furniture consist of DEDON fiber woven over a powder coated aluminum frame. To clean the surface, use a soft cloth or brush, warm water and a gentle cleanser if needed. The elegant feet are made of stainless steel. They can be cleaned regularly with fresh water. Never use steel wool to clean the stainless steel, as it will contaminate the stainless steel, causing rust.			<b>DE MATERIAL</b> Die Möbel der PAROS Kollektion bestehen aus DEDON-Faser, die auf einen pulverbeschichteten Aluminiumrahmen geflochten ist. Um die Oberfläche zu reinigen, benutzen Sie ein weiches Tuch oder eine weiche Bürste, warmes Wasser und, falls nötig, ein sanftes Reinigungsmittel. Die eleganten Füße bestehen aus Edelstahl. Sie können regelmäßig mit Wasser gereinigt werden. Verwenden Sie niemals Stahlwolle zum Reinigen von Edelstahl, da diese den Edelstahl verunreinigt und Rost verursacht.			



# PAROS

Design by JEAN-MARIE MASSAUD



PAROS Setting 01

- 1x **00113015162** PAROS 3-seater, silt
- 1x **95113215650** PAROS Dry+ plush cushion set, LINEN off white
- 1x **00113012162** PAROS 2-seater, silt
- 1x **95113212650** PAROS Dry+ plush cushion set, LINEN off white
- 4x **95113297650** PAROS Additional side cushion, LINEN off white
- 2x **00073005164** DALA Lounge chair, rioja
- 2x **95073237661** DALA Dry+ plush seat cushion, TWIST sand
- 2x **95073205661** DAL Dry+ plush back cushion, TWIST sand

- 1x **00073036164** DALA Side table, rioja
- 1x **00933040343** IZON Coffee table 120 x 120 cm, lipari/talc
- 1x **00933070343** IZON Coffee table 50 x 130 cm, lipari/talc
- 1x **00073052164** DALA Planter M, rioja
- 1x **00073050164** DALA Planter S, rioja
- 1x **00073062167** DALA Lantern L, ibiza
- 1x **00073061167** DALA Lantern M, ibiza
- 1x **00073060167** DALA Lantern S, ibiza

RECOMMENDED DECO CUSHIONS:

- 2x **95050081480** Deco cushion 40 x 40 cm, NATURA laurel
- 1x **95050082480** Deco cushion 50 x 50 cm, NATURA laurel
- 1x **95050082661** Deco cushion 50 x 50 cm, TWIST sand
- 1x **95050084661** Deco cushion 60 x 60 cm, TWIST sand



PAROS Setting 03

- 1x **00113003162** PAROS Right module, silt
- 1x **95113212682** PAROS Dry+ plush cushion, MAR beech
- 1x **00113004162** PAROS Right corner module, silt
- 1x **95113204682** PAROS Dry+ plush cushion set, MAR beech
- 2x **95113297682** PAROS Additional side cushion, MAR beech

- 1x **00917020317** IZON Side table Ø 54,4 cm, black pepper/HPL
- 1x **00917050317** IZON Coffee table Ø 111 cm, black pepper/HPL
- 2x **00707305625** SEAX Lounge chair, black pepper/sail taupe
- 1x **00098025125** VID Carpet solid 300 x 400 cm, canvas

RECOMMENDED DECO CUSHIONS:

- 1x **95050081678** Deco cushion 40 x 40 cm, Kvadrat® Patio450
- 1x **95050082479** Deco cushion 50 x 50 cm, NATURA pomelo
- 1x **95050084647** Deco cushion 60 x 60 cm, LINEN flax



PAROS Setting 02

- 1x **00113003162** PAROS Right module, silt
- 1x **95113212706** PAROS Dry+ plush cushion, GLAN drift
- 1x **00113006162** PAROS Left corner module, silt
- 1x **95113204706** PAROS Dry+ plush cushion, GLAN drift
- 1x **95113298706** PAROS Set of 2 Dry+ plush back cushions, GLAN drift
- 1x **00113005162** PAROS Left module, silt
- 1x **95113212706** PAROS Dry+ plush cushion, GLAN drift
- 2x **95113297706** PAROS Additional side cushion, GLAN drift

- 1x **00105035205** SEALINE Coffee table 69 x 174 cm, teak
- 1x **00085006126** MBRACE Lounge chair, arabica
- 1x **95085016815** MBRACE Seat cushion, Kvadrat® Atrium351
- 1x **00085032126** MBRACE Footstool, arabica
- 1x **95085032815** MBRACE Seat cushion, Kvadrat® Atrium351
- 1x **00085034341** MBRACE Side table Ø 35 cm, black
- 1x **00101030000** LOON Floor lamp L
- 1x **00101010000** LOON Floor lamp S

RECOMMENDED DECO CUSHIONS:

- 2x **95050081815** Deco cushion 40 x 40 cm, Kvadrat® Atrium351
- 1x **95050082815** Deco cushion 50 x 50 cm, Kvadrat® Atrium351
- 1x **95050082681** Deco cushion 50 x 50 cm, Kvadrat® Patio970
- 1x **95050084681** Deco cushion 60 x 60 cm, Kvadrat® Patio970
- 1x **95050089706** Deco cushion 30 x 45 cm, GLAN drift
- 1x **95050085815** Deco cushion 40 x 50 cm, Kvadrat® Atrium351



PAROS Setting 04

- 1x **00113015162** PAROS 3-seater, silt
- 1x **95113215652** PAROS Dry+ plush cushion, LINEN warm gray
- 2x **95113297652** PAROS Additional side cushion, LINEN warm gray
- 1x **00085306126** MBRACE ALU Lounge chair, arabica
- 1x **95085006652** MBRACE ALU Cushion, LINEN warm gray
- 1x **00085332126** MBRACE ALU Footstool, arabica
- 1x **95085032652** MBRACE ALU Seat cushion, LINEN warm gray
- 1x **00085304126** MBRACE ALU Wing chair, arabica

- 1x **95085016652** MBRACE ALU Seat cushion, LINEN warm gray
- 1x **95085005652** MBRACE ALU Headrest cushion, LINEN warm gray
- 1x **00933070343** IZON Coffee table 50 x 130 cm, lipari/talc
- 1x **00929010133** IZON Side table 39 x 39 cm, nori/glass nori
- 1x **00093030128** THE OTHERS Lantern L, cloud
- 1x **00093020128** THE OTHERS Lantern M, cloud

RECOMMENDED DECO CUSHIONS:

- 1x **95050081676** Deco cushion 40 x 40 cm, Kvadrat® Patio110
- 1x **95050082708** Deco cushion 50 x 50 cm, GLAN teal
- 1x **95050089708** Deco cushion 30 x 45 cm, GLAN teal
- 2x **95050085676** Deco cushion 40 x 50 cm, Kvadrat® Patio110

# PORCINI

Design by LORENZA BOZZOLI



Side table marrone | Side table alba | Side table bosco | Side table carrara



# PORCINI

Design by LORENZA BOZZOLI

## Typology

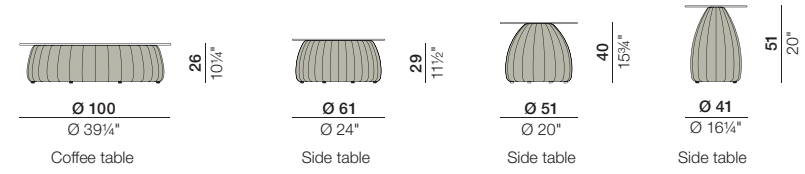

## Materials

### Combinations

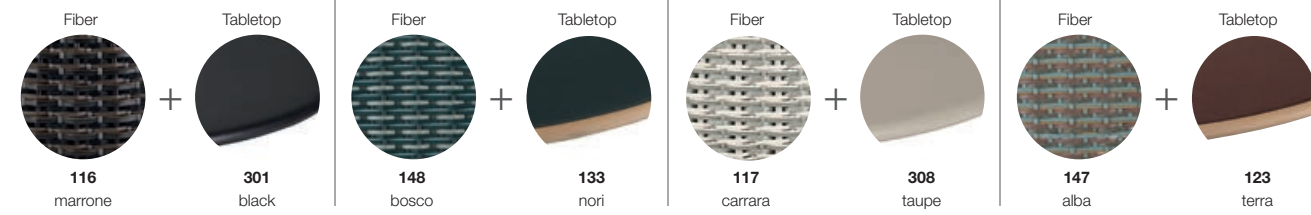

RRP/UMP

SIDE TABLE  
Beistelltisch

Ø 61 cm  
12,5 kg  
Ø 24"  
28 lbs

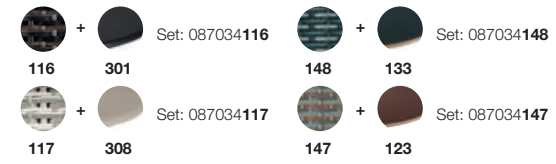

Set: 087034117



56087034000

087034

SIDE TABLE  
Beistelltisch

Ø 51 cm  
9 kg  
Ø 20"  
20 lbs

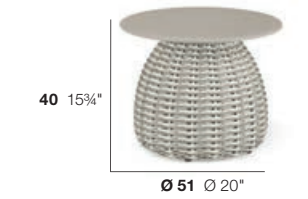
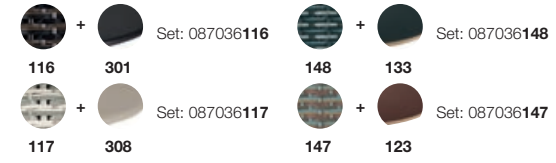

Set: 087036117



56087036000

087036

SIDE TABLE  
Beistelltisch

Ø 41 cm  
8 kg  
Ø 16 1/4"  
18 lbs

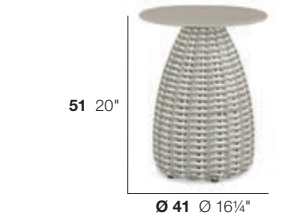
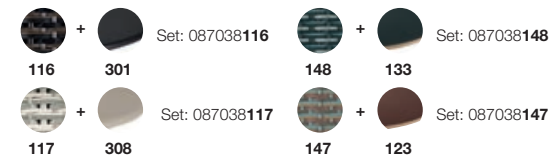

Set: 087038117



56087038000

087038

COFFEE TABLE  
Kaffeetisch

Ø 100 cm  
26,9 kg  
Ø 39 1/4"  
60 lbs

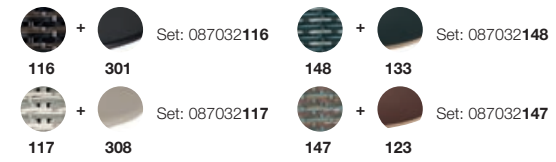

Set: 087032117



56087032000

087032

EN MATERIAL

The woven base consists of a mix of DEDON Fiber and marine rope, interlaced through a powder coated aluminum structure. The tabletops are made of Monolite Ipergres®, a frost-proof ceramic material that is non-absorbing and highly resistant to indirect tensile stress, impacts, scratches and abrasion.

Ceramic tabletops are made in traditional handwork. This may cause variations that make each piece truly unique. Do not cover in the winter months and ensure sufficient air circulation. Clean with a soft cloth and warm water.

DE MATERIAL

Die Untergestelle bestehen aus einem Mix aus DEDON-Faser und Seilen, eingeflochten in ein pulverbeschichtetes Alugeflecht. Die Tischplatten aus Keramik werden aus Monolite Ipergres® gefertigt, einem frostsicheren, wasserabweisenden Keramikmaterial mit ausgezeichneter Kratz- und Abriebfestigkeit.

Keramik-Tischplatten werden in traditioneller Handarbeit gefertigt. Dadurch können Abweichungen entstehen, die jedes Stück zu einem unverwechselbaren Unikat machen. In den Wintermonaten nicht abdecken und für ausreichend Luftzirkulation sorgen. Einfach mit einem weichen Tuch und warmem Wasser zu reinigen.





# RILLY

Design by GAMFRATESI



Cocoon chair, taupe touch | Cocoon chair, saffron touch | Cushions: TWIST gray





# RILLY

Design by GAMFRATESI

## Typology

cm inch

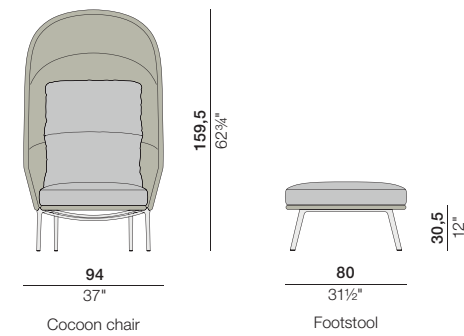

## Materials

### Combinations

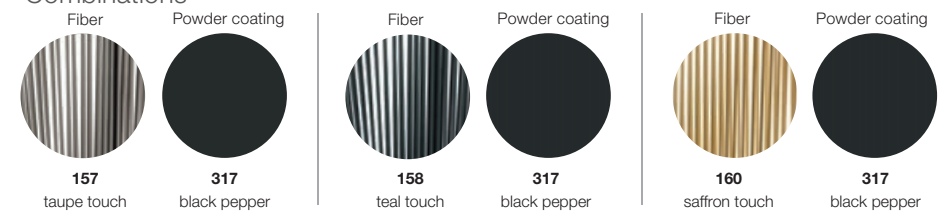

## Fabric Information (see page 224)

Items of this collection are available in all fabrics Cat. A, B & Cat. C (only Kvadrat® Atrium).  
Artikel dieser Kollektion sind in den Stoffen der Kat. A, B & Kat. C (nur Kvadrat® Atrium) verfügbar.

### RRP/VP

COCOON CHAIR  
Cocoon Sessel

17,5 kg  
39 lbs



157



158



160

103008

FOOTSTOOL  
Hocker

4,7 kg  
10 lbs



157



158



160

103032

### EN MATERIAL

RILLY furniture consist of DEDON fiber "touch" woven over a powder coated aluminum frame. The fiber is characterized by its extraordinary soft touch and matte look. To clean the surface, use a soft cloth or brush, warm water and a gentle cleanser if needed.

### DE MATERIAL

Die Möbel der RILLY Kollektion bestehen aus der DEDON-Faser "touch", die auf einen pulverbeschichteten Aluminiumrahmen geflochten ist. Die Faser besticht durch ihre ungewöhnlich weiche Haptik und ihren matten Look. Um die Oberfläche zu reinigen, benutzen Sie ein weiches Tuch oder eine weiche Bürste, warmes Wasser und, falls nötig, ein sanftes Reinigungsmittel.

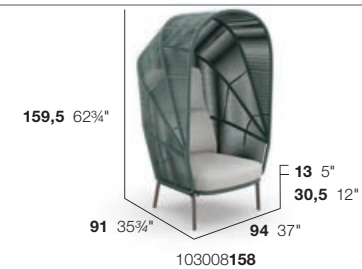

DRY+ CUSHION SET INCLUDING  
BACK CUSHION WITH HEADREST  
Dry+ KissenSet inkl. Rückenkissen mit Kopfstütze  
COM 2,40 M



95103208 56103008000

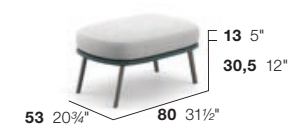

DRY+ SEAT CUSHION  
Dry+ Sitzkissen  
COM 1,25 M



95103232 56103032000





# ROI

Design by BENJAMIN BAUM for DEDON DESIGN STUDIO



Armchair, tobacco | Lounge chair, tobacco | Side chair, tobacco | Layers: TWIST gray



# ROII

Design by BENJAMIN BAUM for DEDON DESIGN STUDIO

## Typology

cm inch

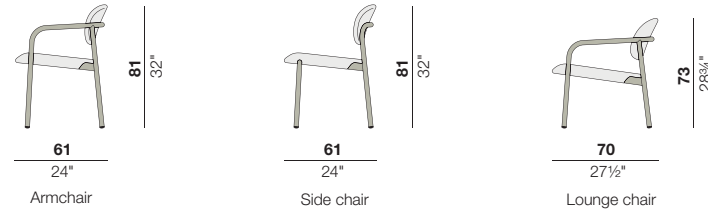

## Materials

Fiber Frame



## Fabric Information (see page 224)

Layers for this collection are available in all fabrics Cat. A, B, C.  
Auflagen für diese Kollektion sind in allen Stoffen der Kat. A, B, C verfügbar.

RRP/UVP

ARMCHAIR  
Armlehnstuhl

5,2 kg  
12 lbs

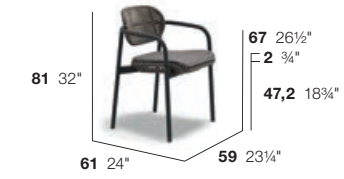

LAYER  
Auflage  
COM 0,60 M



112201

SIDE CHAIR  
Esststuhl

4,6 kg  
10 lbs



LAYER  
Auflage  
COM 0,60 M



112203

LOUNGE CHAIR  
Sessel

5,6 kg  
13 lbs



LAYER  
Auflage  
COM 0,70 M

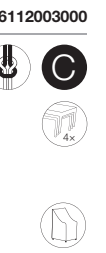

112205

EN MATERIAL

ROII furniture consists of DEDON fiber woven over a powder coated aluminum frame. To clean the surface, use a soft cloth or brush, warm water and a gentle cleanser if needed.

DE MATERIAL

Die Möbel der ROII Kollektion bestehen aus DEDON-Faser, die auf einen pulverbeschichteten Aluminiumrahmen geflochten ist. Um die Oberfläche zu reinigen, benutzen Sie ein weiches Tuch oder eine weiche Bürste, warmes Wasser und, falls nötig, ein sanftes Reinigungsmittel.



# ROI

Design by BENJAMIN BAUM for DEDON DESIGN STUDIO



ROI Setting 01

- 4x 00112205174 ROI Lounge chair, tobacco
- 1x 00937040344 IZON Coffee table 120 x 120 cm, lava
- 1x 00937070344 IZON Coffee table 50 x 130 cm, lava
- 1x 00073062164 DALA Lantern L, rioja
- 1x 00073061164 DALA Lantern M, rioja
- 2x 00073060164 DALA Lantern S, rioja



ROI Setting 02

- 3x 00112203174 ROI Side chair, tobacco
- 3x 00112201174 ROI Armchair, tobacco
- 3x 00050140317 SATELLITE Dining table Ø 70 cm, black pepper



ROI Setting 03

- 4x 00112201174 ROI Armchair, tobacco
- 4x 95112001680 ROI Layer, Kvadrat® Patio370
- 1x 00089085205 TIBBO Dining table Ø 150 cm, teak



ROI Setting 04

- 6x 00112201174 ROI Armchair, tobacco
- 1x 00108770203 BELLMONDE Dining table 95 x 220 cm, black pepper/ebony





# SATELLITE

Design by JEAN-MARIE MASSAUD



Side table, black pepper | Dining table, lipari

## Typology

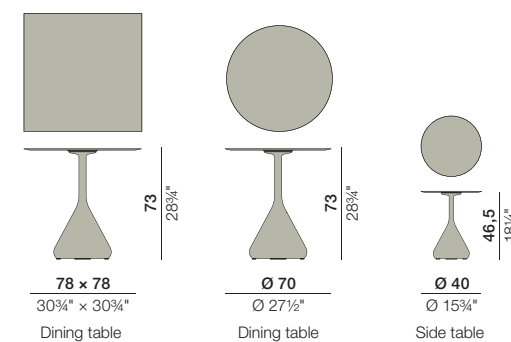

## Materials

### Powder coatings

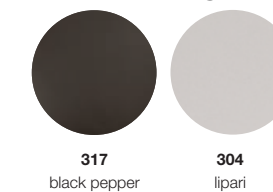

### Tabletops HPL

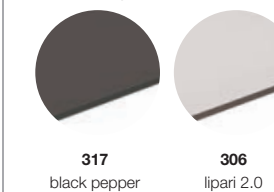

### RRP/UVF

#### DINING TABLE Esstisch

78 x 78 cm  
48,5 kg  
30 3/4" x 30 3/4"  
107 lbs

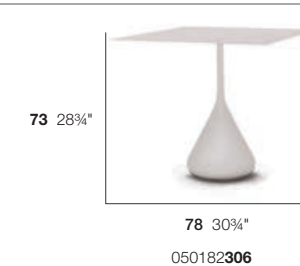

#### 050182

#### DINING TABLE Esstisch

Ø 70 cm  
40,5 kg  
Ø 27 1/2"  
91 lbs



#### 050140

#### SIDE TABLE Beistelltisch

Ø 40 cm  
5,8 kg  
Ø 15 3/4"  
16 lbs



#### 050133

#### EN MATERIAL

The SATELLITE tabletops consist of HPL - a material that is highly resistant to impact, mechanical stress, moisture and steam. To clean a HPL tabletop, use a soft cloth, warm water and a gentle cleanser if needed. The base is made of powder coated aluminum. Clean with a soft cloth and warm water.

#### DE MATERIAL

Die Tischplatten der SATELLITE Kollektion bestehen aus HPL, einem Material, das sich durch hohe Stoßfestigkeit und extreme Widerstandskraft gegen mechanische Einwirkungen, Feuchtigkeit und Dampf auszeichnet. Zur Reinigung der Tischplatte eignen sich ein weiches Tuch, warmes Wasser und bei Bedarf ein sanftes Reinigungsmittel. Der Fuß der SATELLITE Tische besteht aus pulverbeschichtetem Aluminium. Einfach mit einem weichen Tuch und warmem Wasser reinigen.





# SEALINE

Design by JEAN-MARIE MASSAUD



Right module XL, silver beige | Extended daybed left, silver beige | Cushion: GLAN drift | Coffee table 174 x 69 cm | Bench





# SEALINE

Design by JEAN-MARIE MASSAUD

## Typology

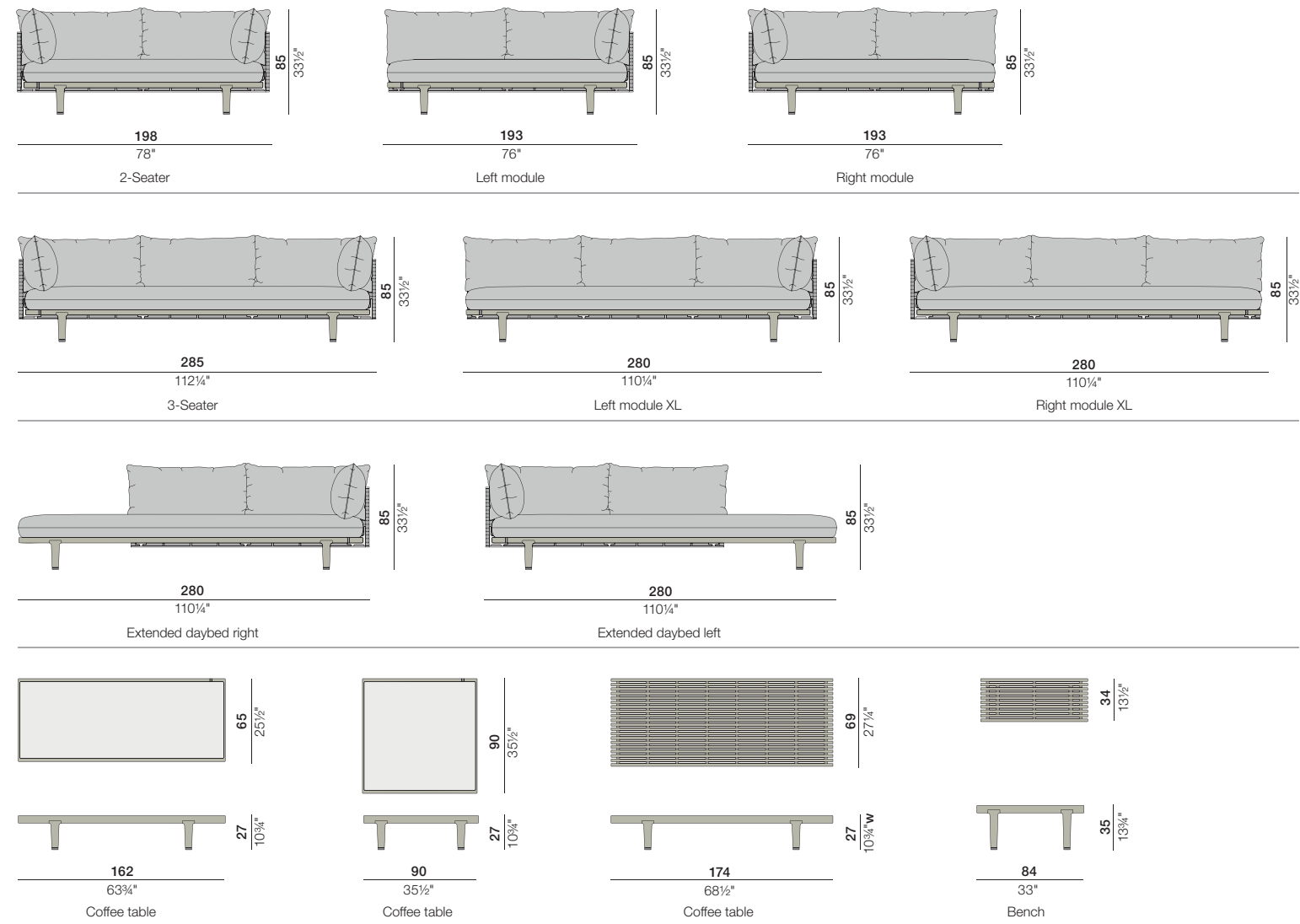

## Materials

### DEDON EcoCycle Fiber

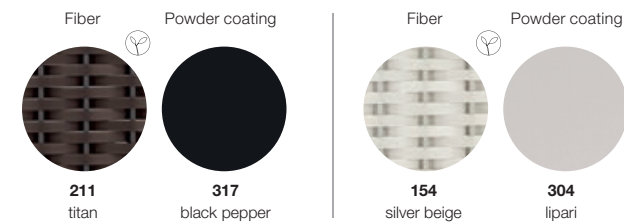

## Fabric Information (see page 224)

Cushions for this collection are available in all fabrics Cat. A, B, C.  
Kissen für diese Kollektion sind in allen Stoffen der Kat. A, B, C verfügbar.

### RRP/UMP

2-SEATER  
2er-Sofa  
39,5 kg  
88 lbs

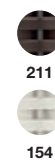

DRY+ CUSHION SET  
Dry+ Kissenset  
COM 6,80 M

DRY+ ADDITIONAL BACK CUSHION  
Dry+ Zusätzliches Rückenkissen  
COM 1,00 M

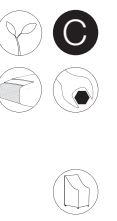

### 105012

LEFT MODULE  
Modul links  
36 kg  
80 lbs

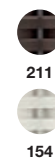

DRY+ CUSHION SET  
Dry+ Kissenset  
COM 5,90 M

DRY+ ADDITIONAL BACK CUSHION  
Dry+ Zusätzliches Rückenkissen  
COM 1,00 M



### 105005

RIGHT MODULE  
Modul rechts  
36 kg  
80 lbs

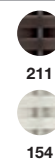

DRY+ CUSHION SET  
Dry+ Kissenset  
COM 5,90 M

DRY+ ADDITIONAL BACK CUSHION  
Dry+ zusätzliches Rückenkissen  
COM 1,00 M



### 105003

3-SEATER  
3er-Sofa  
49 kg  
108 lbs

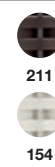

DRY+ CUSHION SET  
Dry+ Kissenset  
COM 8,90 M

DRY+ ADDITIONAL BACK CUSHION  
Dry+ Zusätzliches Rückenkissen  
COM 1,00 M

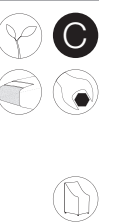

### 105015

LEFT MODULE XL  
Modul links XL  
45 kg  
99 lbs

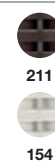

DRY+ CUSHION SET  
Dry+ Kissenset  
COM 8,00 M

DRY+ ADDITIONAL BACK CUSHION  
Dry+ Zusätzliches Rückenkissen  
COM 1,00 M



### 105006

RIGHT MODULE XL  
Modul rechts XL  
45 kg  
99 lbs

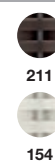

DRY+ CUSHION SET  
Dry+ Kissenset  
COM 8,00 M

DRY+ ADDITIONAL BACK CUSHION  
Dry+ Zusätzliches Rückenkissen  
COM 1,00 M



### 105004

RECOMMENDED DECO CUSHIONS  
Empfohlene Dekokissen

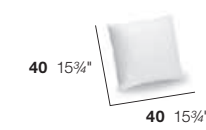
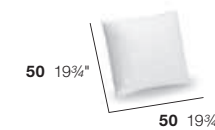

95050082

95050081



RRP/UVF

EXTENDED DAYBED LEFT  
Verlängertes Daybed links

41 kg  
90 lbs

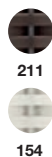

DRY+ CUSHION SET  
Dry+ Kissenset  
COM 6,90 M

DRY+ ADDITIONAL BACK CUSHION  
Dry+ Zusätzliches Rückenkissen  
COM 1,00 M



105017

105017211

Set 95105217

2x 95105297

56105017000

EXTENDED DAYBED RIGHT  
Verlängertes Daybed rechts

41 kg  
90 lbs

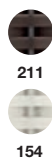

DRY+ CUSHION SET  
Dry+ Kissenset  
COM 6,90 M

DRY+ ADDITIONAL BACK CUSHION  
Dry+ zusätzliches Rückenkissen  
COM 1,00 M



105018

105018211

Set 95105217

2x 95105297

56105018000

COFFEE TABLE  
Kaffeetisch

69 x 174 cm  
27 1/4" x 68 1/2"  
32,5 kg  
72 lbs



105035205

56105036000

COFFEE TABLE  
Kaffeetisch

162 x 65 cm  
63 3/4" x 25 1/2"  
36,5 kg  
80 lbs

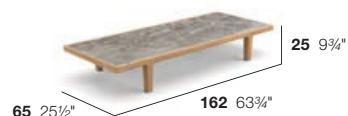
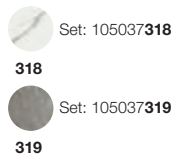

Set: 105037319

56105037000

COFFEE TABLE  
Kaffeetisch

90 x 90 cm  
35 1/2" x 35 1/2"  
24 kg  
53 lbs

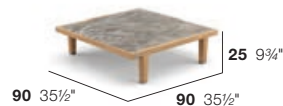
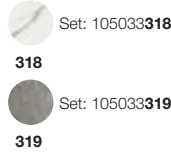

Set: 105033319

56105033000

105033

BENCH  
Bank

10 kg  
22 lbs

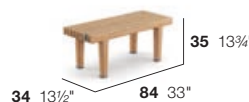

105011205

56105010000

Tabletops Coffee tables & Bench

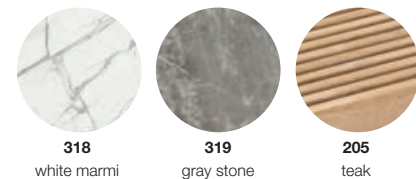

EN MATERIAL

The backrests of the SEALINE collection consist of DEDON EcoCycle fiber woven over a powder coated aluminum frame. The DEDON EcoCycle fiber is made of polyethylene from renewable agricultural raw materials (ethanol from sugar cane). To clean the surface, use a soft cloth or brush, warm water and a gentle cleanser if needed.

The frame of the seat is made of teak. Wash using DEDON teak cleaner. To retain the golden-brown color of unweathered teak, we recommend applying DEDON teak oil at least once in every six months.

The tabetops are made of mineral composite. Clean with a soft cloth and warm water.

FUNCTION

The backrests of the left and right modules and left and right modules XL can be flipped and used on the opposite sides.

DE MATERIAL

Die Rückenlehnen der SEALINE Kollektion bestehen aus der DEDON EcoCycle Faser, die auf einen pulverbeschichteten Alurahmen geflochten ist. Hergestellt wird die DEDON EcoCycle Faser aus Polyethylen aus nachwachsenden landwirtschaftlichen Rohstoffen (Ethanol aus Zuckerrohr). Um die Oberfläche zu reinigen, benutzen Sie ein weiches Tuch oder eine weiche Bürste, warmes Wasser und, falls nötig, ein sanftes Reinigungsmittel.

Die Rahmen der Sitzflächen sowie die teak Beistelltische bestehen aus Teakholz. Reinigen Sie das Teakholz mit DEDON Teak Reiniger. Um den ursprünglichen, goldbraunen Farbton zu bewahren, tragen Sie mindestens alle sechs Monate das DEDON Teak Öl auf.

Die Tischplatten sind aus Mineralkompositwerkstoff gefertigt. Einfach mit einem weichen Tuch und warmem Wasser reinigen.

FUNKTION

Die Rückenlehnen der linken und rechten XL-Module können auf die jeweils andere Seite umgelegt werden.



# SEALINE

Design by JEAN-MARIE MASSAUD



SEALINE Setting 01

- 1x 00105012154 SEALINE 2-seater, silver beige
- 1x 95105212811 SEALINE Dry+ cushion set, Kvadrat® AtriumD13
- 1x 00105018154 SEALINE Extended daybed right, silver beige
- 1x 95105217811 SEALINE Dry+ cushion set, Kvadrat® AtriumD13
- 1x 00105035205 SEALINE Coffee table, teak
- 4x 95105297707 SEALINE Dry+ additional back cushion, GLAN shale
- 1x 00085004140 MBRACE Wing chair, sea salt

- 1x 95085016811 MBRACE Seat cushion, Kvadrat® AtriumD13
- 1x 95085005811 MBRACE Headrest cushion, Kvadrat® AtriumD13
- 1x 00085032140 MBRACE Footstool, sea salt
- 1x 95085032811 MBRACE Seat cushion, Kvadrat® AtriumD13
- 1x 00085036300 MBRACE Side table Ø 50 cm, chalk
- 1x 00101030000 LOON Floor lamp L
- 1x 00101010000 LOON Floor lamp S
- 2x 00098030124 VID Carpet fringes 200 x 300 cm, light gray

RECOMMENDED DECO CUSHIONS:

- 2x 95050082650 Deco cushion 50 x 50 cm, LINEN off white
- 2x 95050084650 Deco cushion 60 x 60 cm, LINEN off white
- 1x 95050089650 Deco cushion 30 x 45 cm, LINEN off white
- 1x 95050085707 Deco cushion 50 x 40 cm, GLAN shale



SEALINE Setting 03

- 1x 00105018211 SEALINE Extended daybed right, titan
- 1x 95105217652 SEALINE Dry+ cushion set, LINEN warm gray
- 1x 00105005211 SEALINE Left module, titan
- 1x 95105203652 SEALINE Dry+ cushion set, LINEN warm gray
- 5x 95105297652 SEALINE Dry+ additional back cushion, LINEN warm gray

- 1x 00105033319 SEALINE Coffee table 90 x 90 cm, gray stone
- 1x 00105011205 SEALINE Bench, teak
- 1x 00093140000 THE OTHERS Statue TOBO
- 1x 00093092003 THE OTHERS Optional set of eyes, midnight
- 1x 00093100000 THE OTHERS Statue TEBU

RECOMMENDED DECO CUSHIONS:

- 1x 95050081707 Deco cushion 40 x 40 cm, GLAN shale
- 2x 95050082706 Deco cushion 50 x 50 cm, GLAN drift
- 1x 95050084706 Deco cushion 60 x 60 cm, GLAN drift
- 1x 95050086707 Deco cushion 70 x 70 cm, GLAN shale



SEALINE Setting 02

- 1x 00105012154 SEALINE 2-seater, silver beige
- 1x 95105212677 SEALINE Dry+ cushion set, Kvadrat® Patio140
- 1x 00105004154 SEALINE Right module XL, silver beige
- 1x 95105204677 SEALINE Dry+ cushion set, Kvadrat® Patio140
- 1x 00105003154 SEALINE Right module, silver beige
- 1x 95105203677 SEALINE Dry+ cushion set, Kvadrat® Patio140
- 1x 00105033318 SEALINE Coffee table 90 x 90 cm, white marmi

- 1x 00105035205 SEALINE Coffee table, teak
- 1x 00105011205 SEALINE Bench, teak
- 2x 00703305633 SEAX Lounge chair, lipari / sail dove
- 1x 00073051168 DALA Planter L, bahamas
- 1x 00073060168 DALA Lantern S, bahamas
- 1x 00073061168 DALA Lantern M, bahamas
- 1x 00073062168 DALA Lantern L, bahamas

RECOMMENDED DECO CUSHIONS:

- 1x 95050081664 Deco cushion 40 x 40 cm, TWIST dark turquoise
- 3x 95050082708 Deco cushion 50 x 50 cm, GLAN teal
- 3x 95050084684 Deco cushion 60 x 60 cm, MAR nori
- 1x 95050086664 Deco cushion 70 x 70 cm, TWIST dark turquoise



SEALINE Setting 04

- 1x 00105004211 SEALINE Right module XL, titan
- 1x 95105204706 SEALINE Dry+ cushion set, GLAN drift
- 1x 00105017211 SEALINE Extended daybed left, titan
- 1x 95105217706 SEALINE Dry+ cushion set, GLAN drift
- 1x 00105015211 SEALINE 3-seater, titan

- 1x 95105215706 SEALINE Dry+ cushion set, GLAN drift
- 1x 00105037319 SEALINE Coffee table, gray stone
- 1x 00105033319 SEALINE Coffee table, gray stone
- 1x 00105011205 SEALINE Bench, teak

RECOMMENDED DECO CUSHIONS:

- 2x 95050081477 Deco cushion 40 x 40 cm, NATURA garnet
- 1x 95050081815 Deco cushion 40 x 40 cm, Kvadrat® Atrium351
- 1x 95050082815 Deco cushion 50 x 50 cm, Kvadrat® Atrium351
- 1x 95050082479 Deco cushion 50 x 50 cm, NATURA pomelo
- 2x 95050084479 Deco cushion 60 x 60 cm, NATURA pomelo
- 1x 95050084815 Deco cushion 60 x 60 cm, Kvadrat® Atrium351





# SEASHELL

Design by JEAN-MARIE MASSAUD



Side chairs, chalk | Cushion: NATURA white



# SEASHELL

Design by JEAN-MARIE MASSAUD

## Typology

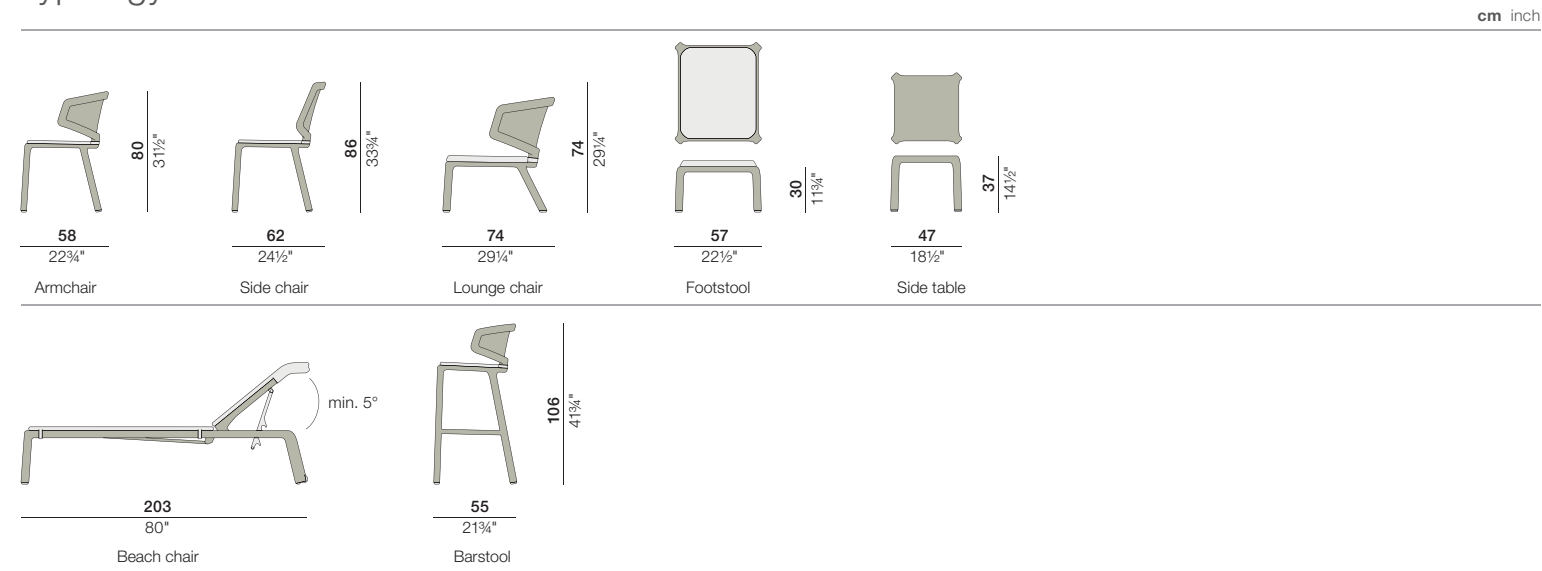

## Materials

### Fiber



## Fabric Information (see page 224)

Items of this collection are available in all fabrics Cat. A, B & Cat. C (only Kvadrat® Atrium).  
 Artikel dieser Kollektion sind in den Stoffen der Kat. A, B & Kat. C (nur Kvadrat® Atrium) verfügbar.

<p>ARMCHAIR Armlehnstuhl</p> <p>4,8 kg 11 lbs</p>	<p>083</p>		<p>SEAT CUSHION Sitzkissen</p> <p>COM 0,54 M</p>	
<p>049001</p>	<p>049001083</p>	<p>95049001</p>	<p>56049001000</p>	

<p>RRP/UVF</p> <p>SIDE CHAIR Esststuhl</p> <p>4,6 kg 10 lbs</p>	<p>083</p>		<p>SEAT CUSHION Sitzkissen</p> <p>COM 0,54 M</p>	
<p>049003</p>	<p>049003083</p>	<p>95049001</p>	<p>56049003000</p>	

<p>LOUNGE CHAIR Sessel</p> <p>7,4 kg 16 lbs</p>	<p>083</p>		<p>SEAT CUSHION Sitzkissen</p> <p>COM 1,02 M</p>	
<p>049005</p>	<p>049005083</p>	<p>95049005</p>	<p>56049005000</p>	

<p>FOOTSTOOL Hocker</p> <p>3,8 kg 9 lbs</p>	<p>083</p>		<p>SEAT CUSHION Sitzkissen</p> <p>COM 0,69 M</p>	
<p>049031</p>	<p>049031083</p>	<p>95049031</p>	<p>56049031000</p>	

<p>SIDE TABLE Beistelltisch</p> <p>47 x 47 cm 2,5 kg 18 1/2" x 18 1/2" 6 lbs</p>	<p>083</p>		<p>049033</p>	
<p>049033</p>	<p>049033083</p>	<p>56049033000</p>		

<p>BEACH CHAIR WITH HOOK-CATCHING Sonnenliege mit Stufenverstellung</p> <p>16 kg 35 lbs</p>	<p>083</p>		<p>CUSHION Kissen</p> <p>COM 4,32 M</p>	
<p>049020</p>	<p>049020083</p>	<p>95049020</p>	<p>56049020000</p>	

<p>BARSTOOL Barhocker</p> <p>6 kg 13 lbs</p>	<p>083</p>		<p>049028</p>	
<p>049028</p>	<p>049028083</p>	<p>56049028000</p>		

**EN MATERIAL**  
 SEASHELL furniture consist of DEDON fiber woven over a powder coated aluminum frame. To clean the surface, use a soft cloth or brush, warm water and a gentle cleanser if needed.

**DE MATERIAL**  
 Die Möbel der SEASHELL Kollektion bestehen aus DEDON-Faser, die auf einen pulverbeschichteten Aluminiumrahmen geflochten ist. Um die Oberfläche zu reinigen, benutzen Sie ein weiches Tuch oder eine weiche Bürste, warmes Wasser und, falls nötig, ein sanftes Reinigungsmittel.



# SEAX

Design by JEAN-MARIE MASSAUD

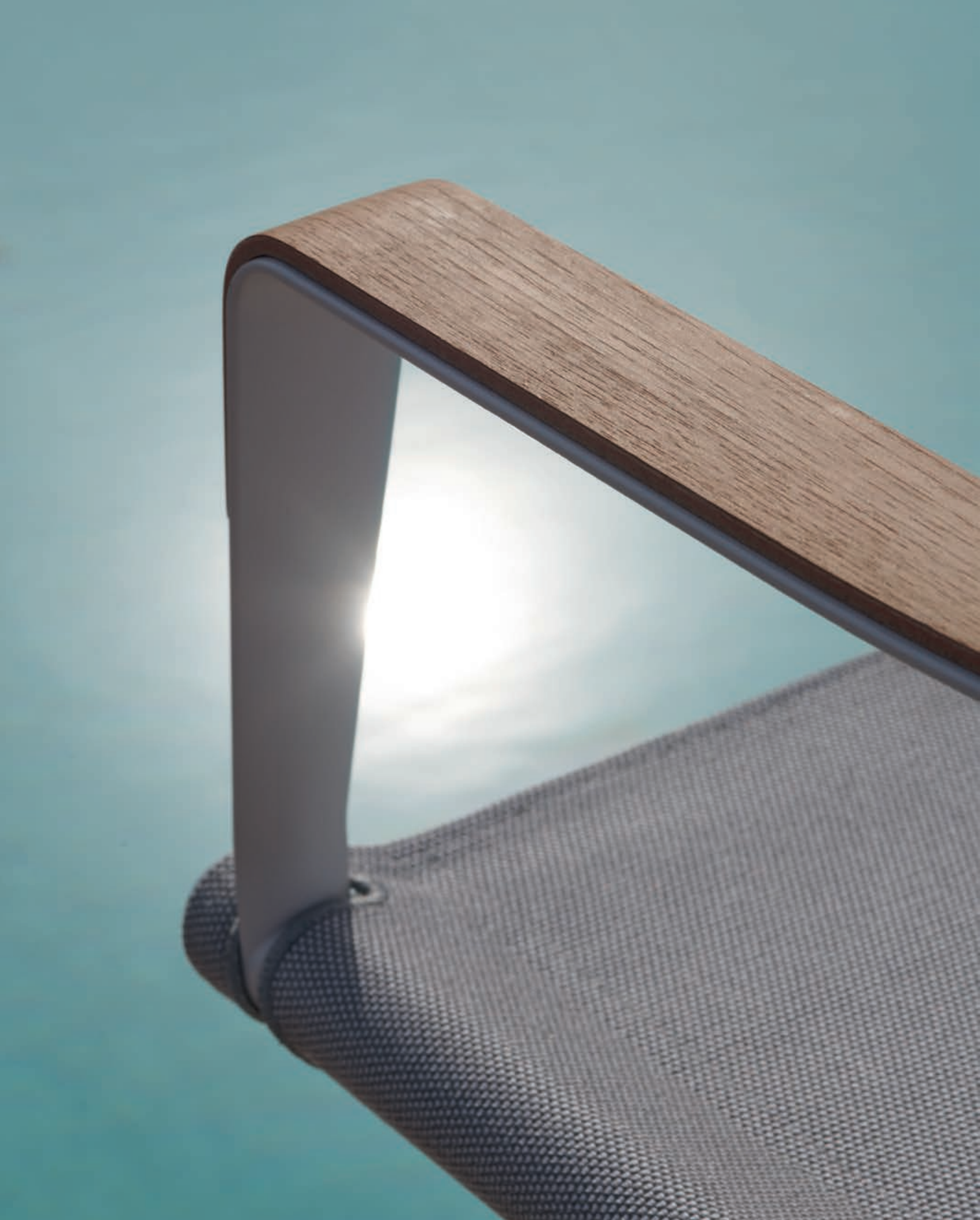

Armchairs lipari, sail taupe

# SEAX

Design by JEAN-MARIE MASSAUD

## Typology

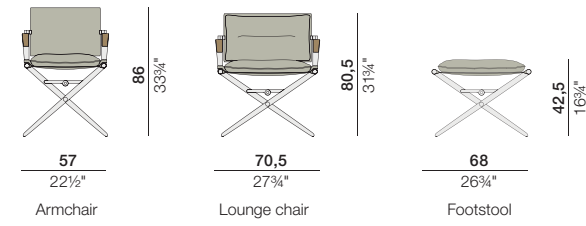

## Materials

### Combinations

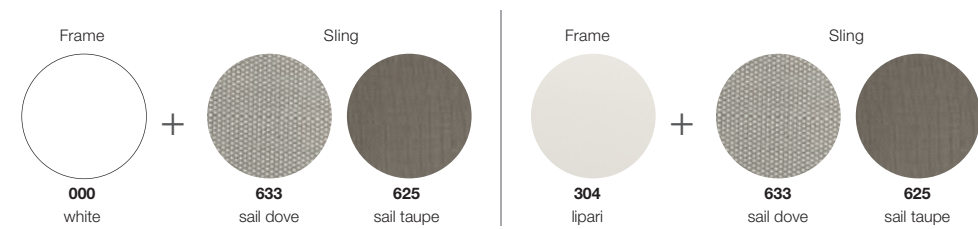
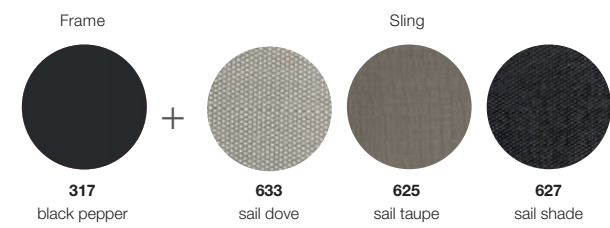

### Armrests



## Fabric Information (see page 224)

Cushions for this collection are available in all fabrics Cat. A, B & Cat. C (only Kvadrat® Atrium).  
Kissen für diese Kollektion sind in den Stoffen der Kat. A, B & Kat. C (nur Kvadrat® Atrium) verfügbar.

RRP/UVF

ARMCHAIR  
Armlehnstuhl

7 kg  
15 lbs

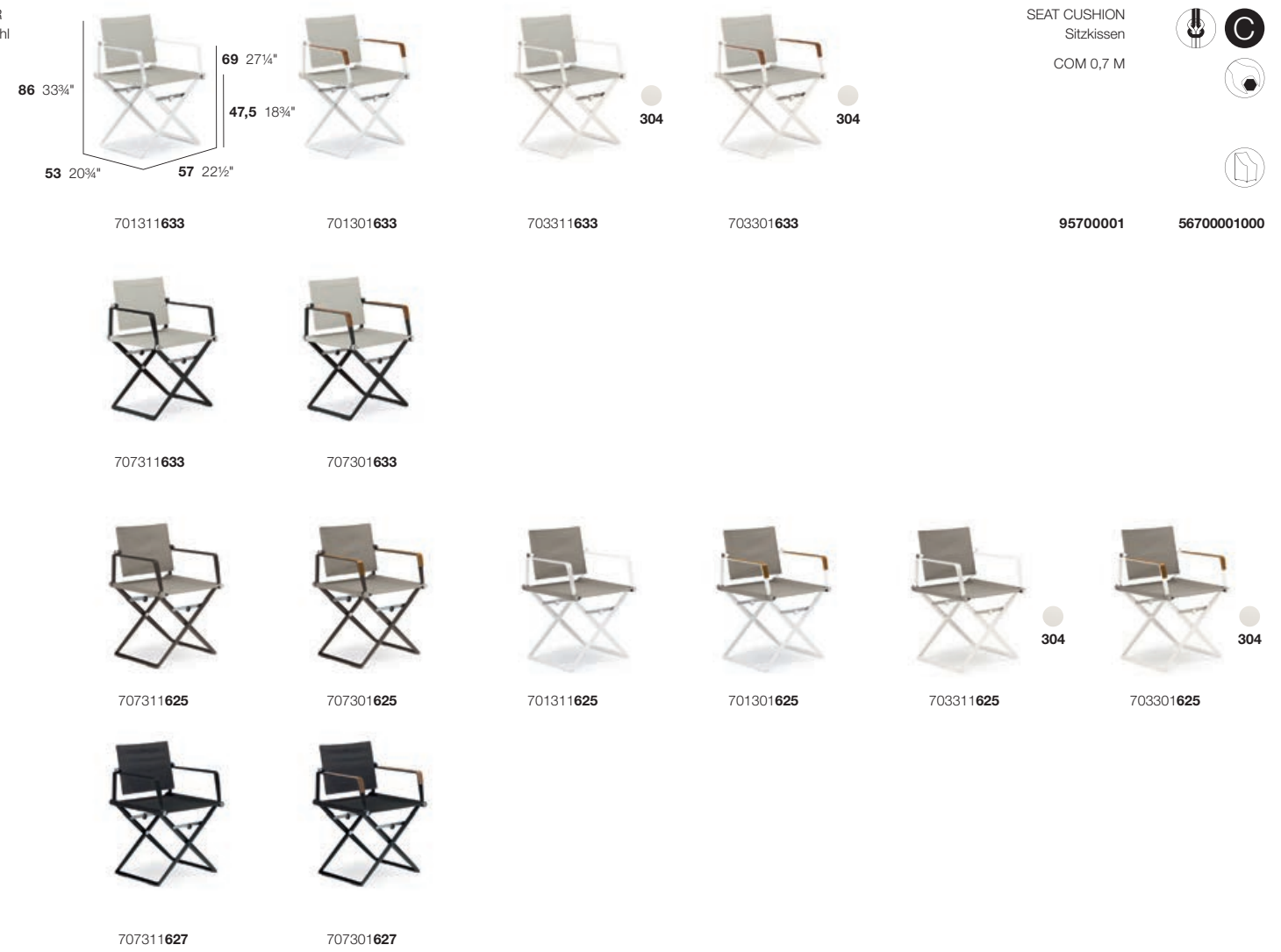

SEAT CUSHION  
Sitzkissen  
COM 0,7 M





RRP/UVF

LOUNGE CHAIR  
Sessel

8 kg  
18 lbs

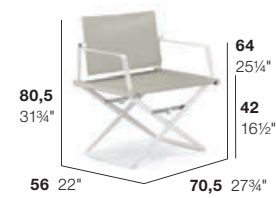

SEAT CUSHION + BACK CUSHION  
Sitzkissen + Rückenkissen  
COM 1,26 M



701315633

701305633

703315633

703305633

95700005

56700005000



707315633

707305633



707315625

707305625

701315625

701305625

703315625

703305625



707315627

707305627

RRP/UVF

FOOTSTOOL  
Hocker

5 kg  
11 lbs

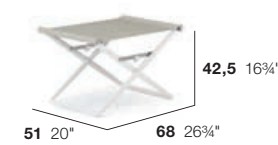

701031633

703031633

SEAT CUSHION  
Sitzkissen  
COM 0,8 M



95700031

56700031000



707031633



707031625



701031625



703031625



707031627

ALL ITEMS ARE FOLDABLE.  
Alle Produkte sind faltbar.



SEAT CUSHION ARMCHAIR  
Sitzkissen Armlehnstuhl

COM 0,7 M



SEAT CUSHION + BACK CUSHION LOUNGE CHAIR  
Sitzkissen + Rückenkissen Sessel

COM 1,26 M

SEAT CUSHION FOOTSTOOL  
Sitzkissen Hocker

COM 0,8 M



EN MATERIAL

The structure of the SEAX armchair and lounge chair is made of powder coated die-cast aluminum. The seat and back textile is a mix of PVC, acrylic and polyester. The armrest covers are made out of teak-finished plywood.  
Clean the frame, seat and backrest with a soft cloth and warm water. Clean the plywood armrest covers with a damp cloth and do not apply cleaning detergents of any kind. To maintain their beautiful wood finish, the SEAX armchairs and lounge chairs with plywood armrests should be protected from moisture and kept indoors when not in use. For a low-maintenance seating alternative, choose the armchair and lounge chair without plywood armrests.

DE MATERIAL

Die Rahmen von SEAX Armlehnstuhl und Sessel bestehen aus pulverbeschichtetem, druckgepresstem Aluminium. Sitzfläche und Rückenlehne bestehen aus einem Stoff, der aus PVC, Acryl und Polyester gefertigt wird. Das Holzdekor der Armlehnen besteht aus mit Teakholz beschichtetem Schichtholz. Rahmen, Sitz und Lehne mit einem weichen Tuch und warmem Wasser reinigen. Die Schichtholz-Armlehnen reinigen Sie mit einem feuchten Tuch und niemals mit Reinigungsmitteln. Schützen Sie die SEAX Armlehnstühle und Sessel vor Feuchtigkeit und bewahren Sie sie im Innenbereich auf, wenn Sie sie nicht nutzen, damit die schöne Holzoberfläche nicht leidet. Als pflegeleichte Alternative wählen Sie den Armlehnstuhl oder den Sessel mit Armlehnen ohne Holzoberflächen.

# SEAX

Design by JEAN-MARIE MASSAUD

## Typology

cm inch

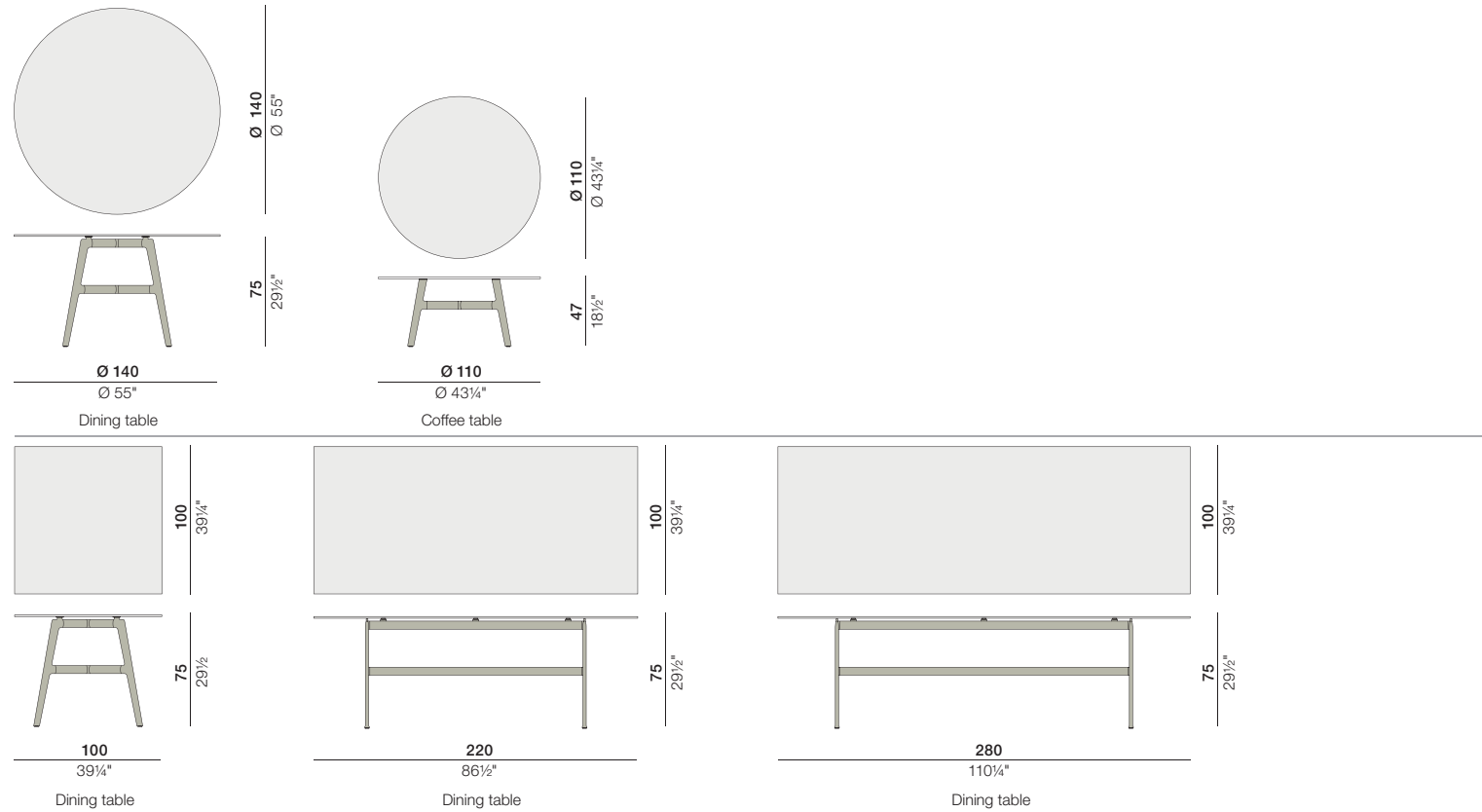

## Materials

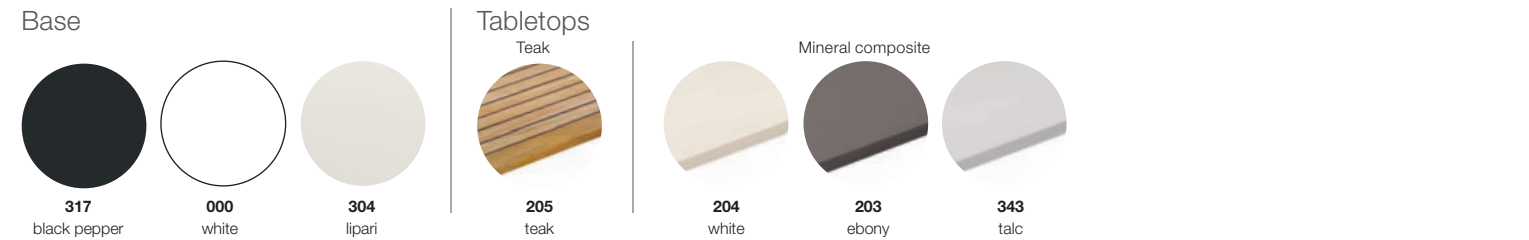

RRP/UVF

DINING TABLE  
Esstisch

Teak  
100 × 100 cm  
39¼" × 39¼"  
30 kg  
67 lbs

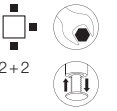
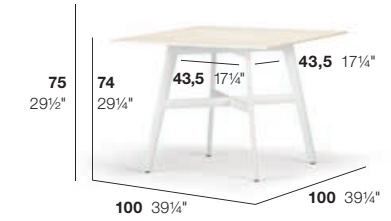
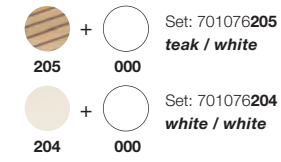

Mineral Composite  
100 × 100 cm  
39¼" × 39¼"  
40,5 kg  
90 lbs

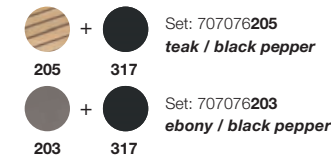
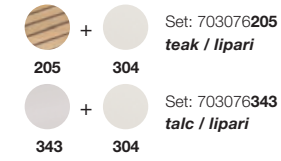

56700076000

DINING TABLE  
Esstisch

Teak  
100 × 220 cm  
39¼" × 86½"  
52 kg  
115 lbs

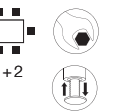
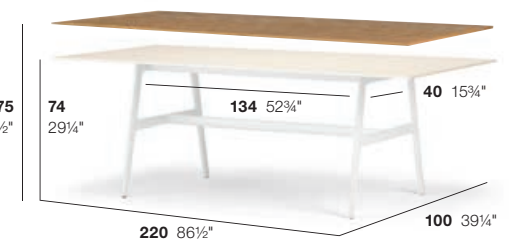
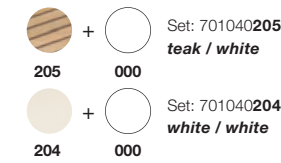

Mineral Composite  
100 × 220 cm  
39¼" × 86½"  
82 kg  
181 lbs

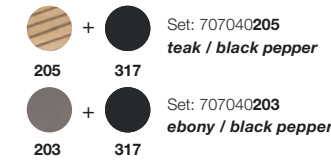
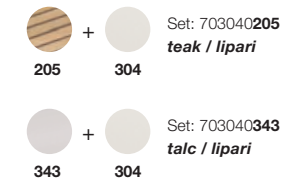

56700040000



RRP/UVP

DINING TABLE  
Esstisch

Teak  
100 × 280 cm  
39¼" × 110¼"  
63 kg  
139 lbs

205 + 000 Set: 701067205  
**teak / white**

204 + 000 Set: 701067204  
**white / white**

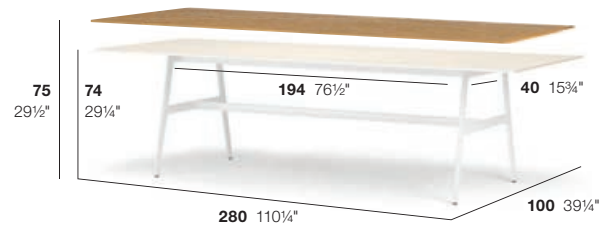

Mineral Composite  
100 × 280 cm  
39¼" × 110¼"  
99 kg  
219 lbs

205 + 304 Set: 703067205  
**teak / lipari**

343 + 304 Set: 703067343  
**talc / lipari**



205 + 317 Set: 707067205  
**teak / black pepper**

203 + 317 Set: 707067203  
**ebony / black pepper**

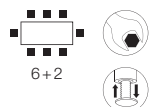

COFFEE TABLE  
Kaffeetisch

Teak  
Ø 110 cm  
Ø 43¼"  
23 kg  
51 lbs

205 + 000 Set: 701036205  
**teak / white**

204 + 000 Set: 701036204  
**white / white**

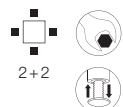
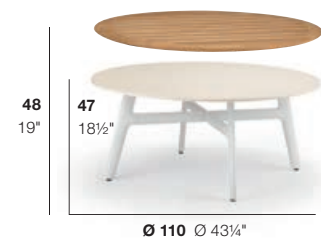

Mineral Composite  
Ø 110 cm  
Ø 43¼"  
40 kg  
89 lbs

205 + 317 Set: 707036205  
**teak / black pepper**

203 + 317 Set: 707036203  
**ebony / black pepper**



56700036000

EN MATERIAL

The base consists of powder coated aluminum profiles with powder coated, die-cast aluminum legs. Mineral composite tabletops come in three options: White, ebony and talc tabletops consist of a self-supporting mineral-composite slab, cut by water jet from the largest premium sintered porcelain slabs available on the market. Teak tabletops consist of premium teak. The sealant used between the teak slats are the same as those widely used on yacht decks and are designed to expand and contract with teak's natural movement. Wash using DEDON teak cleaner. To retain the golden-brown color of unweathered teak, we recommend applying DEDON teak oil at least once in every six months.

DE MATERIAL

Das Gestell besteht aus pulverbeschichteten Aluminiumprofilen mit pulverbeschichteten Aludruckgussbeinen. Die Tischplatten aus freitragendem Mineralverbundmaterial sind in drei Farbvarianten verfügbar: white, ebony und talc. Das Material wird per Wasserstrahl aus den größten am Markt erhältlichen gesinterten Porzellanplatten geschnitten. Einfach mit einem weichen Tuch und warmem Wasser zu reinigen. Die Teak-Tischplatte besteht aus hochwertigem Teakholz. Dichtungsfugen zwischen den Teakleisten erlauben dem Holz, sich im Rahmen seiner natürlichen Bewegung auszudehnen bzw. zusammenzuziehen. Reinigen Sie das Teakholz mit DEDON Teak Reiniger. Um den ursprünglichen goldbraunen Farbton zu bewahren, tragen Sie mindestens alle sechs Monate das DEDON Teak Öl auf.

DINING TABLE  
Esstisch

Teak  
Ø 140 cm  
Ø 55"  
39 kg  
86 lbs

205 + 000 Set: 701046205  
**teak / white**

204 + 000 Set: 701046204  
**white / white**

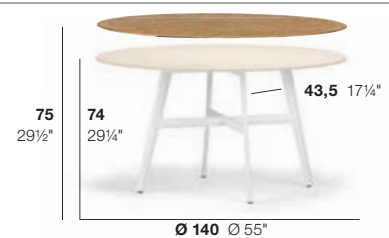

56700067000

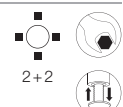

Mineral Composite  
Ø 140 cm  
Ø 55"  
56,5 kg  
125 lbs

205 + 304 Set: 703046205  
**teak / lipari**

343 + 304 Set: 703046343  
**talc / lipari**



205 + 317 Set: 707046205  
**teak / black pepper**

203 + 317 Set: 707046203  
**ebony / black pepper**



56700046000

# SEAX DINING

Design by JEAN-MARIE MASSAUD



SEAX Setting 01

- 8x 00707301625 SEAX Armchair, black pepper/sail taupe
- 1x 00707067205 SEAX Dining table 100 x 280 cm, black pepper/teak



SEAX Setting 02

- 4x 00701301633 SEAX Armchair, white/sail dove
- 1x 00701046204 SEAX Dining table Ø 140 cm, white/white
- 1x 00098025125 VID Carpet solid 300 x 400 cm, canvas
- 1x 00093140000 THE OTHERS Statue TOBO, cloud
- 1x 00093020128 THE OTHERS Lantern M, cloud



SEAX Setting 03

- 4x 00707311633 SEAX Armchair, black pepper/sail dove
- 1x 00707040203 SEAX Dining table 100 x 220 cm, black pepper/ebony



SEAX Setting 04

- 6x 00703301633 SEAX Armchair, lipari/sail dove
- 1x 00603062205 WA Dining table 100 x 200 cm, lipari/teak





# SWINGREST

Design by DANIEL POUZET



Hanging lounger incl. canopy, natural | Cushion: NATURA white



# SWINGREST

Design by DANIEL POUZET

## Typology

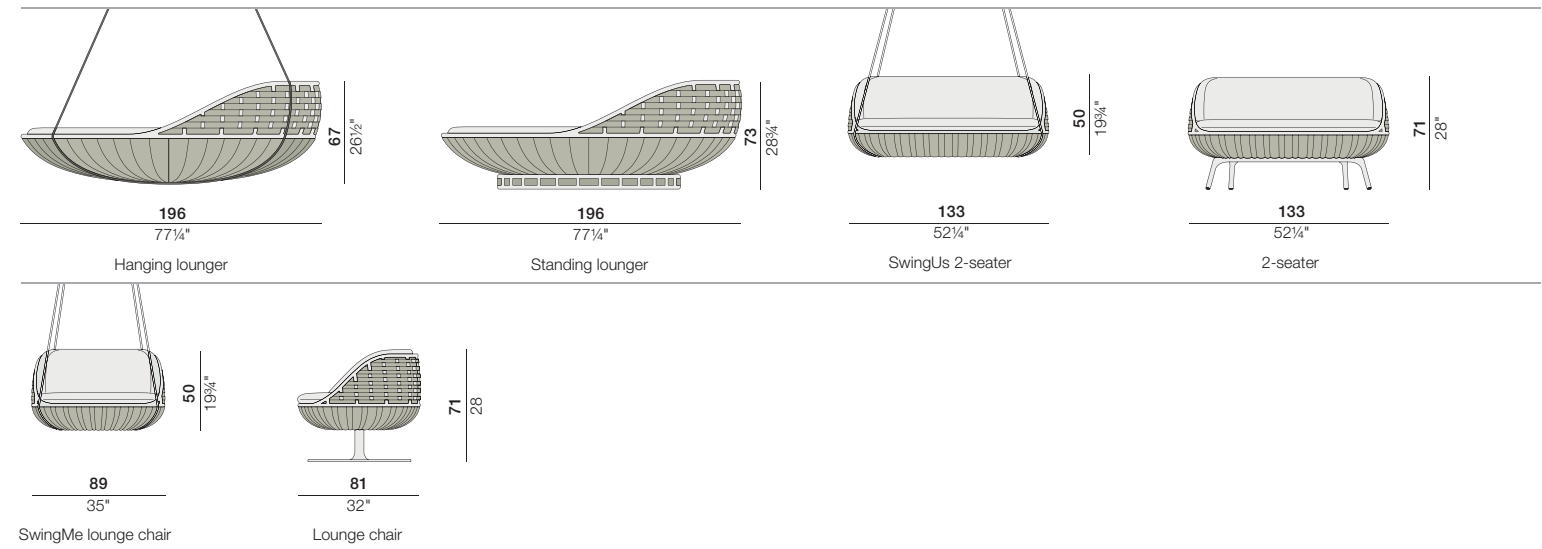

## Materials

### Combinations

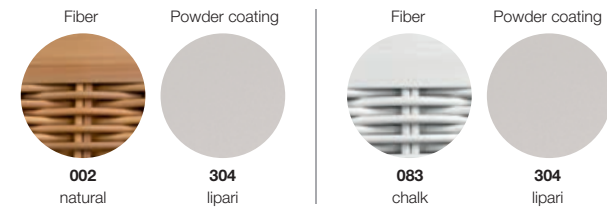

## Fabric Information (see page 224)

Items of this collection are available in all fabrics Cat. A, B & Cat. C (only Kvadrat® Atrium).  
 Artikel dieser Kollektion sind in den Stoffen der Kat. A, B & Kat. C (nur Kvadrat® Atrium) verfügbar.

RRP/UVF

HANGING LOUNGER\*  
 Hanging lounger

45 kg  
 99 lbs

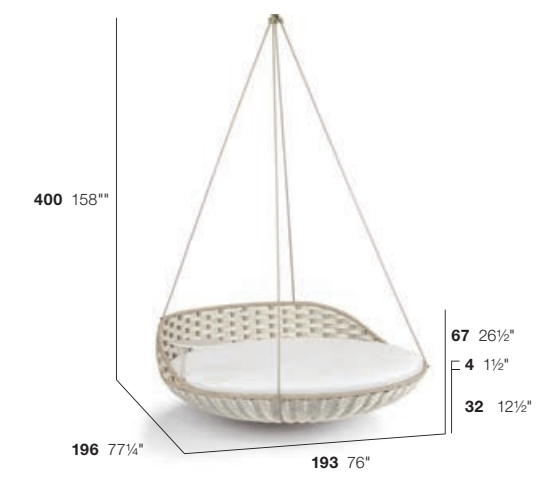
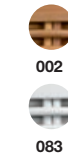

SEAT CUSHION  
 Sitzkissen  
 COM 6,80 M



091021

CANOPY FOR HANGING LOUNGER  
 Himmel für Hanging lounger

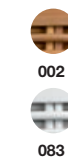

091021083

95090119

0009120002



00091100000

STANDING LOUNGER, INCL. BASE\*  
 Standing lounger, inkl. Untersatz

52,2 kg  
 115 lbs

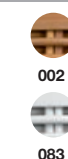

SEAT CUSHION  
 Sitzkissen  
 COM 6,80 M

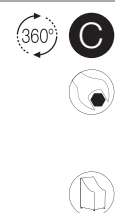

091023

BASE, ROTATING – SUITABLE FOR HANGING AND STANDING LOUNGER  
 Untersatz, drehbar – passend für Hanging und Standing lounger

7,2 kg  
 16 lbs

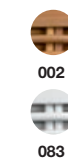

091023083

95090119



091018

RECOMMENDED BACK CUSHION  
 Empfohlene Rückenkissenmenge



6x 95050087

RECOMMENDED DECO CUSHION  
 Empfohlene Dekokissenmenge

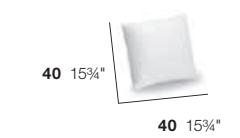

4x 95050081

\* EN ATTENTION  
 Weight capacity 350 kg/772 lbs

\* DE ACHTUNG  
 Tragkraft 350 kg/772 lbs



RRP/UVP  
 SWINGME LOUNGE CHAIR\*  
 SwingMe Sessel

11 kg  
 24 lbs

002  
 083



440 173"  
 50 19 3/4"  
 81 32" 89 35" 8 3 1/4" 17 6 3/4"

SEAT CUSHION  
 Sitzkissen  
 COM 2,45 M

BACK CUSHION  
 Rückenkissen  
 COM 1,70 M

091017 091017083 95091005 95091006 56091005000

LOUNGE CHAIR\*\*  
 Sessel

23 kg  
 51 lbs

002  
 083



71 28"  
 81 32" 89 35" 8 3 1/4" 38 15"

SEAT CUSHION  
 Sitzkissen  
 COM 2,45 M

BACK CUSHION  
 Rückenkissen  
 COM 1,70 M

091007 091007083 95091005 95091006 56091005000

RECOMMENDED BACK CUSHION  
 Empfohlene Rückenkissenmenge

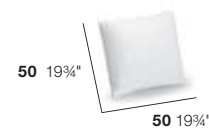

1x 95050082

RECOMMENDED DECO CUSHION  
 Empfohlene Dekokissenmenge

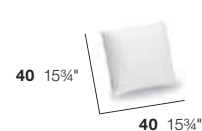

2x 95050081

SWINGUS 2-SEATER\*\*\*  
 SwingUs 2er-Sofa

15 kg  
 33 lbs

002  
 083



440 173"  
 50 19 3/4"  
 81 32" 133 52 1/4" 8 3 1/4" 17 6 3/4"

SEAT CUSHION  
 Sitzkissen  
 COM 2,59 M

BACK CUSHION  
 Rückenkissen  
 COM 2,62 M

091015 091015083 95091012 95091013 56091012000

TETHERING ROPE OPTIONS  
 Opciones de sujecion

HANGING LOUNGER Hanging lounger	SWINGME LOUNGE CHAIR SwingMe Sessel	SWINGUS 2-SEATER SwingUs 2er-Sofa
------------------------------------	--	--------------------------------------

1,4 kg 3,5 lbs	1,4 kg 3,5 lbs	1,4 kg 3,5 lbs
-------------------	-------------------	-------------------

23091005002	23091005004	23091005007
-------------	-------------	-------------

RRP/UVP  
 CANOPY FOR SWINGUS 2-SEATER  
 Himmel für SwingUs 2er-Sofa

002  
 083



230 91"

00091015000

2-SEATER  
 2er-Sofa

15 kg  
 33 lbs

002  
 083



71 28"  
 81 32" 133 52 1/4" 8 3 1/4" 38 15"

SEAT CUSHION  
 Sitzkissen  
 COM 2,59 M

BACK CUSHION  
 Rückenkissen  
 COM 2,62 M

091014 091014083 95091012 95091013 56091012000

RECOMMENDED BACK CUSHION  
 Empfohlene Rückenkissenmenge

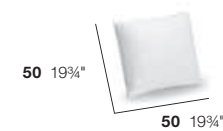

3x 95050082

RECOMMENDED DECO CUSHION  
 Empfohlene Dekokissenmenge

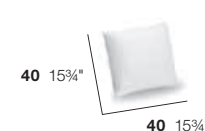

2x 95050081

\* EN ATTENTION Weight capacity 120 kg/265 lbs  
 \*\* Weight capacity 150 kg/331 lbs  
 \*\*\* Weight capacity 240 kg/530 lbs

\* DE ACHTUNG Tragkraft 120 kg/265 lbs  
 \*\* Tragkraft 150 kg/331 lbs  
 \*\*\* Tragkraft 240 kg/530 lbs

EN MATERIAL  
 SWINGREST furniture consist of DEDON fiber woven over a powder coated aluminum frame. The tabletop consist of mineral composite. To clean the surfaces, use a soft cloth or brush, warm water and a gentle cleanser if needed.

DE MATERIAL  
 Die Möbel der SWINGREST Kollektion bestehen aus DEDON-Faser, die auf einen pulverbeschichteten Aluminiumrahmen geflochten ist. Die Tischplatte besteht aus Mineralverbundmaterial. Um die Oberflächen zu reinigen, benutzen Sie ein weiches Tuch oder eine weiche Bürste, warmes Wasser und, falls nötig, ein sanftes Reinigungsmittel.

CANOPY  
 The SWINGREST canopy is made of 100% solution-dyed outdoor acrylic fabric with a color fastness of 7/8. It has a mold-resistant, soil-resistant and water-resistant finishing made with Teflon®. The aluminum ring is wrapped with rope.

HIMMEL  
 Der SWINGREST Himmel besteht aus 100% spinnfärbem Outdoor-Acrylstoff mit einer Lichtechtheit von 7/8. Dank einer Teflon®-Beschichtung ist der Stoff schimmel-, schmutz- und wasserabweisend. Der Aluminiumring ist mit einem Seil umwickelt.

HANGINGS  
 Rope length may be customized upon request. The SwingMe Lounge chair and SwingUs 2-seater may be hung either from a single point, for a rotating swing experience, or from two points, for a back-and-forth one. The canopy for the SwingUs 2-seater fits only when the piece is hung from a single point.

AUFHÄNGUNG  
 Die Seillänge kann auf Anfrage nach Kundenwünschen angepasst werden. Der SwingMe Sessel und das SwingUs 2er-Sofa können entweder an einem oder zwei Hängepunkten befestigt werden. Dadurch werden rotierende oder geradlinige Schaukelbewegungen erzielt. Der Himmel für das SwingUs 2er-Sofa kann nur befestigt werden, wenn das Möbelstück an einem einzigen Hängepunkt montiert wurde.

# TANGO

Design by RICHARD FRINIER

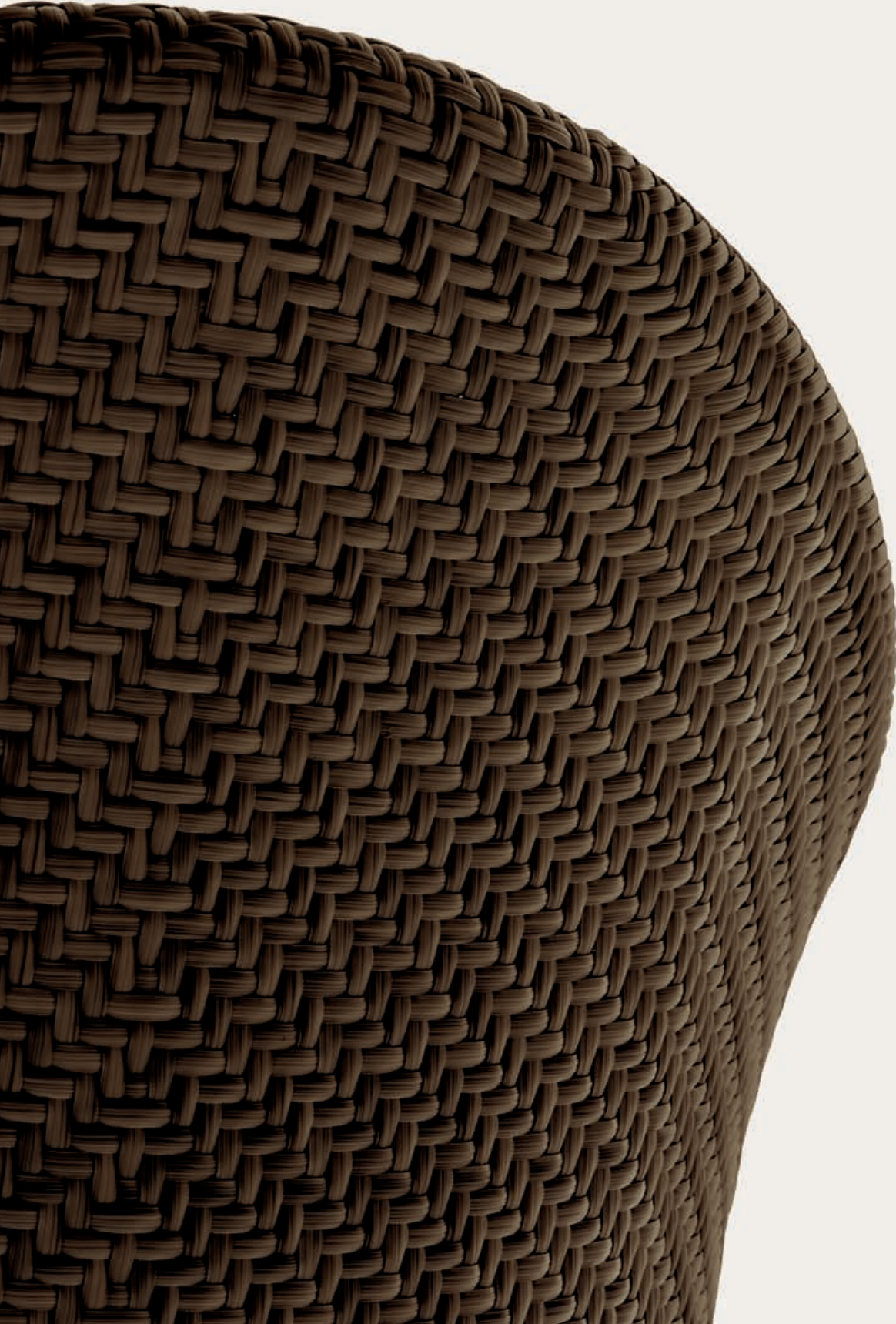

Lounge chair, bronze



# TANGO

Design by RICHARD FRINIER

## Typology

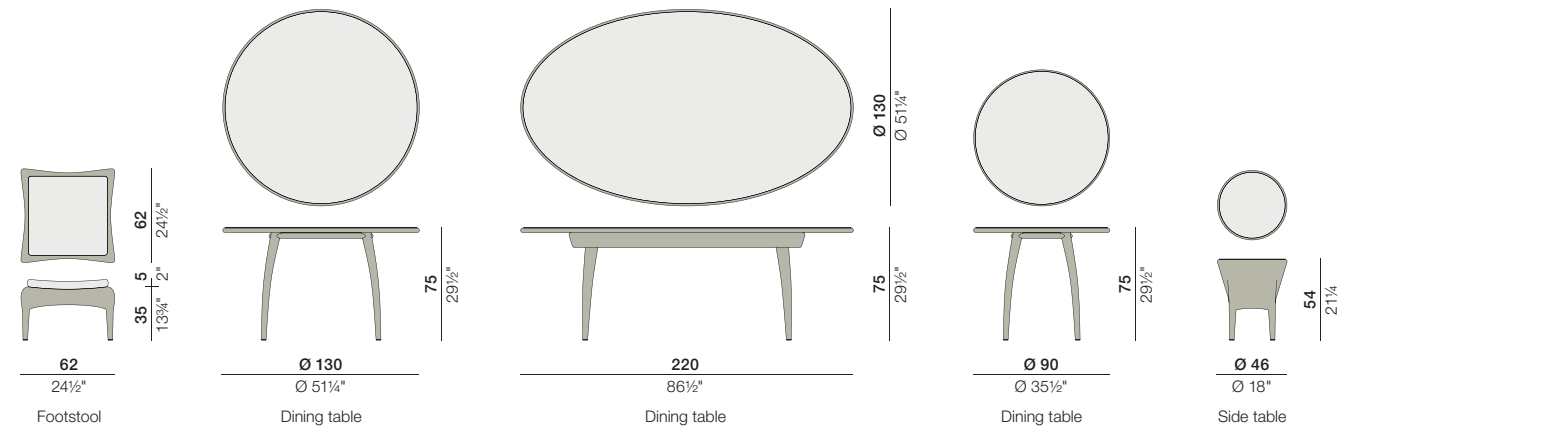
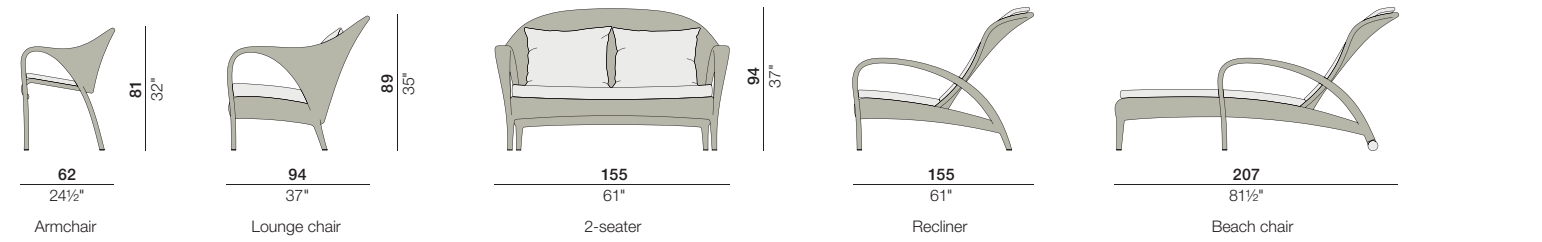

## Materials

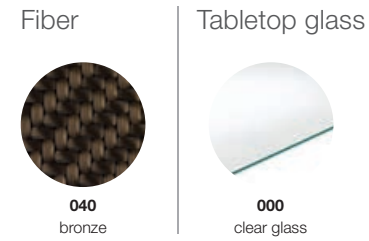

## Fabric Information (see page 224)

Items of this collection are available in all fabrics Cat. A, B & Cat. C (only Kvadrat® Atrium).  
 Artikel dieser Kollektion sind in den Stoffen der Kat. A, B & Kat. C (nur Kvadrat® Atrium) verfügbar.

RRP/UDP ARMCHAIR Armlehnstuhl	<b>040</b>		SEAT CUSHION Sitzkissen COM 0,61 M	
6 kg 13 lbs		<b>68</b> 26¾" <b>3</b> 1¼" <b>47</b> 18½" <b>62</b> 24½" <b>62</b> 24½"		
<b>026001</b>		<b>026001040</b>	<b>95026001</b>	<b>56026001000</b>
DINING TABLE Esstisch	<b>040</b> + <b>000</b>			
Ø 90 cm 16 kg Ø 35½" 35 lbs		<b>25,5</b> 10" <b>Ø 90</b> Ø 35½"		
<b>026046</b>		Set: <b>026046040</b>		<b>56026046000</b>
DINING TABLE Esstisch	<b>040</b> + <b>000</b>			
Ø 130 cm 29 kg Ø 51¼" 64 lbs		<b>54</b> 21¼" <b>Ø 130</b> Ø 51¼"		
<b>026050</b>		Set: <b>026050040</b>		<b>56026050000</b>
DINING TABLE Esstisch	<b>040</b> + <b>000</b>			
130 x 220 cm 55,5 kg 51¼" x 86½" 123 lbs		<b>117</b> 46" <b>35</b> 13¾" <b>220</b> 86½" <b>130</b> 51¼"		
<b>026076</b>		Set: <b>026076040</b>		<b>56026076000</b>
LOUNGE CHAIR Sessel	<b>040</b>		SEAT CUSHION + BACK CUSHION Sitzkissen + Rückenkissen COM 1,35 M	
9 kg 20 lbs		<b>69</b> 27¼" <b>8</b> 3¼" <b>35</b> 13¾" <b>94</b> 37" <b>84</b> 33"		
<b>026005</b>		<b>026005040</b>	Set <b>95026005</b>	<b>56026005000</b>
2-SEATER 2er-Sofa	<b>040</b>		SEAT CUSHION + 2x BACK CUSHIONS Sitzkissen + 2x Rückenkissen COM 2,73 M	
15 kg 33 lbs		<b>69</b> 27¼" <b>8</b> 3¼" <b>35</b> 13¾" <b>99</b> 39" <b>155</b> 61"		
<b>026012</b>		<b>026012040</b>	Set <b>95026012</b>	<b>56026012000</b>



RRP/UVF

FOOTSTOOL  
Hocker



040

6 kg  
13 lbs

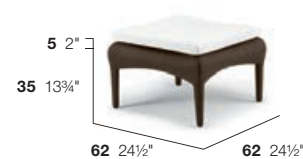

026031040

SEAT CUSHION  
Sitzkissen



COM 1,25 M



026031

SIDE TABLE  
Beistelltisch

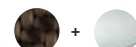

040 000

Ø 46 cm  
6 kg  
Ø 18"  
13 lbs



Ø 46 Ø 18"

Set: 026034040



026034

BEACH CHAIR  
WITH GAS SPRING  
Sonnenliege  
mit Gasdruckfeder



040

17 kg  
37 lbs



026119040

CUSHION  
Kissen



COM 2,49 M



026119

RECLINER  
WITH GAS SPRING  
Liegesessel  
mit Gasdruckfeder



040

13 kg  
29 lbs

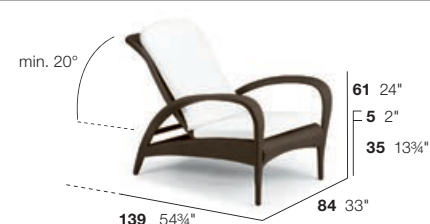

026109040

CUSHION  
Kissen



COM 2,27 M



026109

EN MATERIAL

TANGO furniture consist of DEDON fiber woven over a powder coated aluminum frame.  
To clean the surface, use a soft cloth or brush, warm water and a gentle cleanser if needed.  
To clean the glass tabletop, use a soft cloth, warm water and a gentle cleanser if needed.

DE MATERIAL

Die TANGO Kollektion bestehen aus DEDON-Faser, die auf einen pulverbeschichteten Aluminiumrahmen geflochten ist. Um die Oberfläche zu reinigen, benutzen Sie ein weiches Tuch oder eine weiche Bürste, warmes Wasser und, falls nötig, ein sanftes Reinigungsmittel. Zur Reinigung der Glas-Tischplatte eignen sich ein weiches Tuch, warmes Wasser und bei Bedarf ein sanftes Reinigungsmittel.





# TIBBO

Design by EDWARD BARBER & JAY OSGERBY



Lounge chair | Cushion: NATURA marengo

# TIBBO

Design by EDWARD BARBER & JAY OSGERBY

## Typology

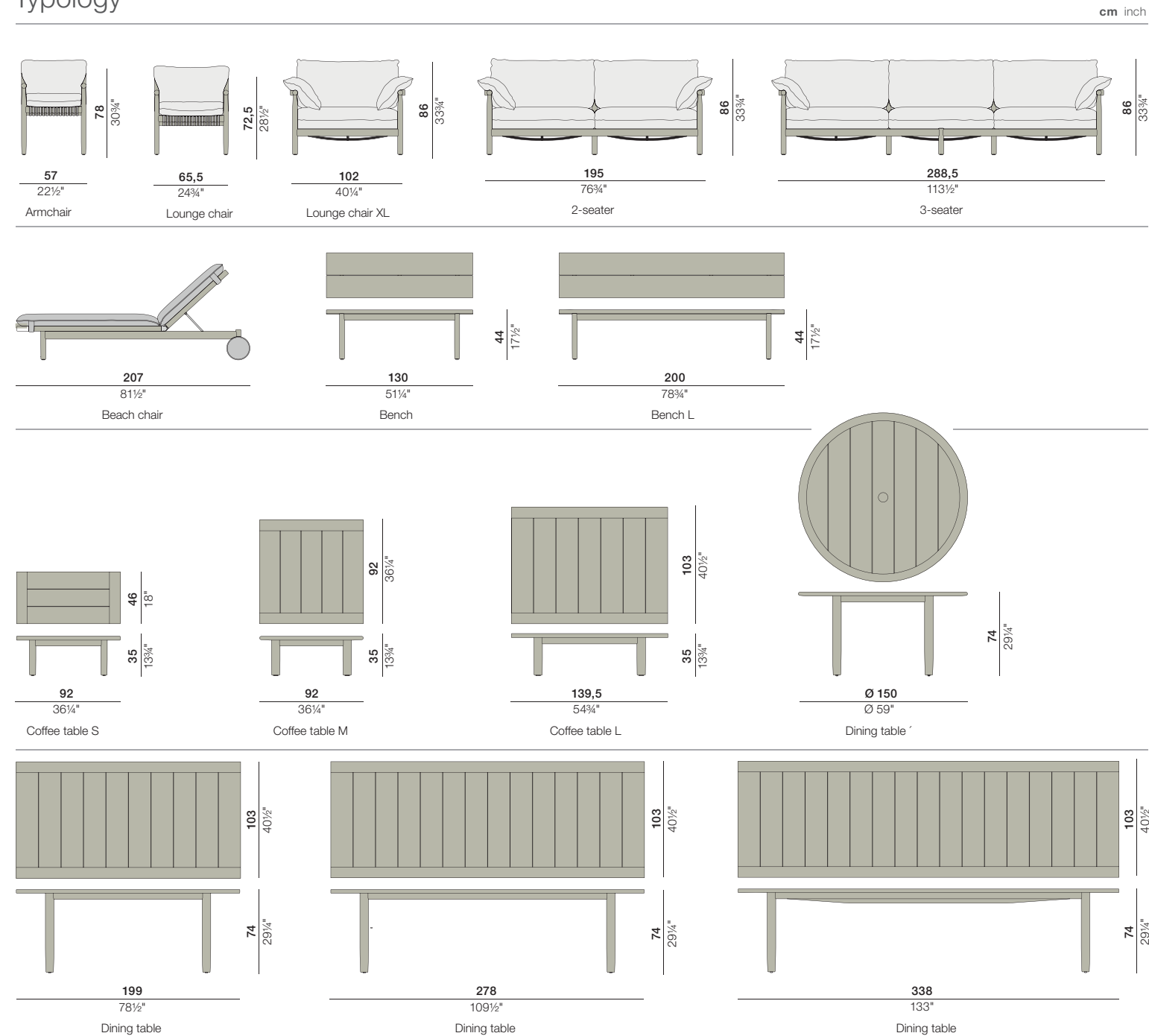

## Materials

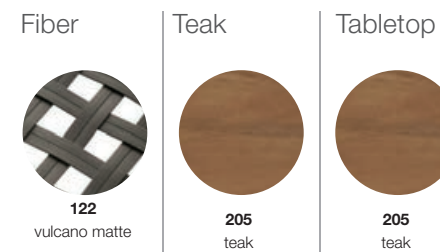

## Fabric Information (see page 224)

Cushions for this collection are available in all fabrics Cat. A, B, C.  
Kissen für diese Kollektion sind in allen Stoffen der Kat. A, B, C verfügbar.

RRP/UVF

ARMCHAIR  
Armlehnstuhl

7 kg  
16 lbs

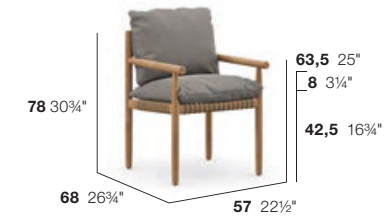

089001

089001122

DRY+ CUSHION  
Dry+ Kissen  
COM 2,00 M



LOUNGE CHAIR  
Sessel

9 kg  
20 lbs



089005

089005122

DRY+ CUSHION  
Dry+ Kissen  
COM 2,60 M

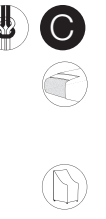

LOUNGE CHAIR XL  
Sessel XL

15,4 kg  
34 lbs



089006

089006122

DRY+ SEAT CUSHION + DRY+ BACK CUSHION + 2x SIDE CUSHIONS  
Dry+ Sitzkissen + Dry+ Rückenkissen + 2x Seitenkissen  
COM 5,50 M



2-SEATER  
2er-Sofa

30 kg  
66 lbs



089013

089013122

DRY+ SEAT CUSHIONS + DRY+ BACK CUSHIONS + 2x SIDE CUSHIONS  
Dry+ Sitzkissen + Dry+ Rückenkissen + 2x Seitenkissen  
COM 9,10 M



3-SEATER  
3er-Sofa

35,4 kg  
78 lbs



089016

089016122

DRY+ SEAT CUSHIONS + DRY+ BACK CUSHIONS + 2x SIDE CUSHIONS  
Dry+ Sitzkissen + Dry+ Rückenkissen + 2x Seitenkissen  
COM 12,80 M

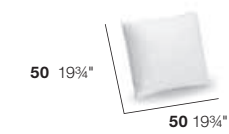

95050082

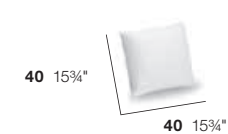

95050081



RRP/UVF

BEACH CHAIR WITH HOOK-CATCHING  
Sonnenliege mit Stufenverstellung

25,6 kg  
57 lbs

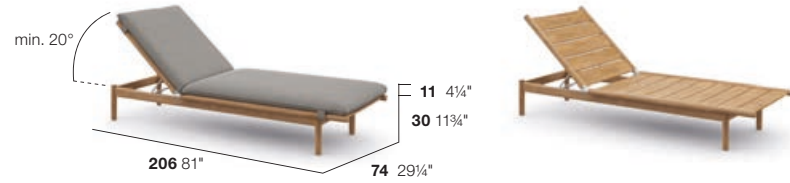

089019 089019205

DRY+ CUSHION  
Dry+ Kissen  
COM 5,80 M



95089219 56089019000

BEACH CHAIR WITH HOOK-CATCHING  
INCL. WHEELS  
Sonnenliege mit Stufenverstellung inkl. Rollen

26 kg  
58 lbs

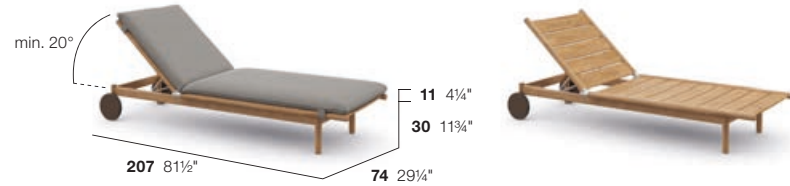

089020 089020205

DRY+ CUSHION  
Dry+ Kissen  
COM 5,80 M

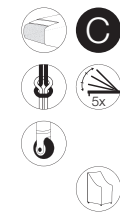

95089219 56089019000

BENCH  
Bank

14 kg  
31 lbs



089012 089012205 56089011000

BENCH L  
Bank L

22 kg  
49 lbs



089015 089015205 56089014000

COFFEE TABLE S  
Kaffeetisch S

92 x 46 cm  
11,3 kg  
36 1/4" x 18"  
25 lbs



089038 089038205 56089038000

COFFEE TABLE M  
Kaffeetisch M

92 x 92 cm  
19 kg  
36 1/4" x 36 1/4"  
42 lbs

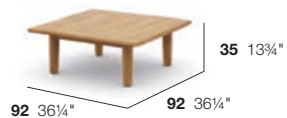

089040 089040205 56089040000

COFFEE TABLE L  
Kaffeetisch L

103 x 139 cm  
28,2 kg  
40 1/2" x 54 3/4"  
62 lbs

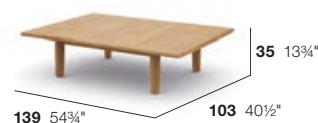

089037 089037205 56089031000

RRP/UVF

DINING TABLE  
Esstisch

103 x 199 cm  
43 kg  
40 1/2" x 78 1/2"  
95 lbs



089065 089065205

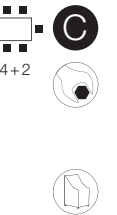

56089066000

DINING TABLE  
Esstisch

103 x 278 cm  
56 kg  
40 1/2" x 109 1/2"  
124 lbs

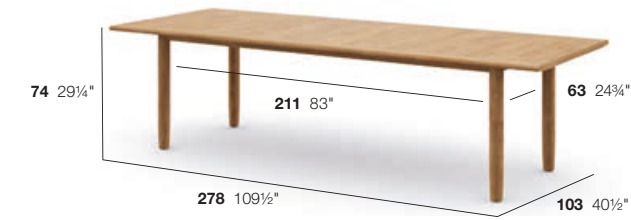

089055 089055205



56089056000

DINING TABLE  
Esstisch

103 x 338 cm  
66 kg  
40 1/2" x 133"  
146 lbs

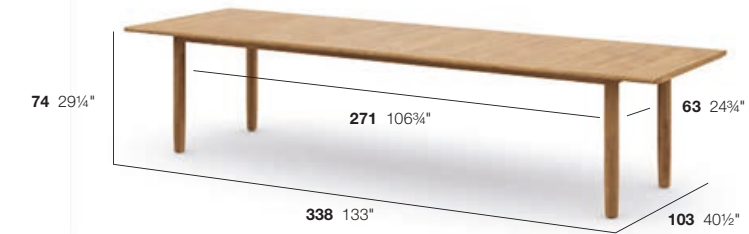

089045 089045205



56089046000

DINING TABLE WITH PARASOL HOLE  
Esstisch mit Schirmloch

Diameter Parasol hole 23 1/4"  
Durchmesser Schirmloch 7 cm

Ø 150 cm  
35 kg  
Ø 59"  
78 lbs

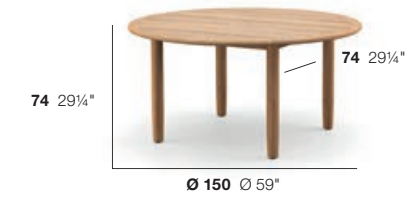

089085 089085205



56089085000

EN MATERIAL

TIBBO frames are made of premium teak. Wash using DEDON teak cleaner. To retain the golden-brown color of unweathered teak, we recommend applying DEDON teak oil at least once in every six months. The seats of the armchairs and lounge chairs consist of woven DEDON fiber. To clean the fiber, use a soft cloth or brush, warm water and a gentle cleanser if needed.

DE MATERIAL

Die Rahmen der TIBBO Kollektion bestehen aus hochwertigem Teakholz. Reinigen Sie das Teakholz mit DEDON Teak Reiniger. Um den ursprünglichen goldbraunen Farbton zu bewahren, tragen Sie mindestens alle sechs Monate das DEDON Teak Öl auf. Die Sitzflächen der Armlehnstühle und Sessel werden aus DEDON Faser gefertigt. Um die Faser zu reinigen, benutzen Sie ein weiches Tuch oder eine weiche Bürste, warmes Wasser und, falls nötig, ein sanftes Reinigungsmittel.

# TIBBO

Design by EDWARD BARBER & JAY OSGERBY



## TIBBO Setting 01

1x 00089013122	TIBBO	2-seater, teak	1x 95085016677	MBRACE	Seat cushion, Kvadrat® Patio140
1x 95089213677	TIBBO	Dry+ cushion set, Kvadrat® Patio140	1x 95085005677	MBRACE	Headrest cushion, Kvadrat® Patio140
1x 00089006122	TIBBO	Lounge chair XL, teak	1x 00085032141	MBRACE	Footstool, baltic
1x 95089206677	TIBBO	Dry+ cushion set, Kvadrat® Patio140	1x 95085032677	MBRACE	Seat cushion, Kvadrat® Patio140
1x 00089037205	TIBBO	Coffee table L, teak	1x 00093140000	THE OTHERS	Statue TOBO
1x 00089038205	TIBBO	Coffee table S, teak	1x 00093130000	THE OTHERS	Statue BUKA
1x 00085008141	MBRACE	Rocking chair, baltic	1x 00093092003	THE OTHERS	Optional set of eyes, midnight

### RECOMMENDED DECO CUSHIONS:

1x 95050081473	Deco cushion	40 x 40 cm, NATURA juniper
1x 95050081681	Deco cushion	40 x 40 cm, Kvadrat® Patio970
1x 95050082676	Deco cushion	50 x 50 cm, Kvadrat® Patio110
1x 95050084473	Deco cushion	60 x 60 cm, NATURA juniper
1x 95050089681	Deco cushion	30 x 45 cm, Kvadrat® Patio970
1x 95050085473	Deco cushion	40 x 50 cm, NATURA juniper



## TIBBO Setting 03

1x 00089013122	TIBBO	2-seater, teak	1x 00087032147	PORCINI	Coffee table Ø 100 cm, alba
1x 95089213660	TIBBO	Dry+ cushion set, TWIST beige	1x 00087036147	PORCINI	Side table Ø 51 cm, alba
1x 00089005122	TIBBO	Lounge chair, teak	1x 00087038147	PORCINI	Side table Ø 41 cm, alba
1x 95089205660	TIBBO	Dry+ cushion set, TWIST beige			

### RECOMMENDED DECO CUSHIONS:

3x 95050081661	Deco cushion	40 x 40 cm, TWIST sand
1x 95050082662	Deco cushion	50 x 50 cm, TWIST gray
1x 95050084663	Deco cushion	60 x 60 cm, TWIST terracotta



## TIBBO Setting 02

1x 00089016122	TIBBO	3-seater, teak	2x 00073005166	DALA	Lounge chair, cuba
1x 95089216815	TIBBO	Dry+ cushion set, Kvadrat® Atrium351	2x 95073237709	DALA	Dry+ plush seat cushion, GLAN terra
1x 00089013122	TIBBO	2-seater, teak	2x 95073205709	DALA	Dry+ plush back cushion, GLAN terra
1x 95089213815	TIBBO	Dry+ cushion set, Kvadrat® Atrium351	1x 00073036166	DALA	Side table, cuba
1x 00089037205	TIBBO	Coffee table L, teak	1x 00073052166	DALA	Planter M, cuba
1x 00089038205	TIBBO	Coffee table S, teak	1x 00073050166	DALA	Planter S, cuba

### RECOMMENDED DECO CUSHIONS:

4x 95050081814	Deco cushion	40 x 40 cm, Kvadrat® Atrium451
1x 95050081679	Deco cushion	40 x 40 cm, Kvadrat® Patio550
1x 95050081709	Deco cushion	40 x 40 cm, GLAN terra
2x 95050082709	Deco cushion	50 x 50 cm, GLAN terra
2x 95050084679	Deco cushion	60 x 60 cm, Kvadrat® Patio550



## TIBBO Setting 04

1x 00089016122	TIBBO	3-seater, teak	1x 00089038205	TIBBO	Coffee table S, teak
1x 95089216649	TIBBO	Dry+ cushion set, LINEN ebony	1x 00089012205	TIBBO	Bench, teak
1x 00089013122	TIBBO	2-seater, teak	1x 00073062164	DALA	Lantern L, rioja
1x 95089213649	TIBBO	Dry+ cushion set, LINEN ebony	1x 00073061164	DALA	Lantern M, rioja
2x 00089006122	TIBBO	Lounge chair XL, teak	1x 00073060164	DALA	Lantern S, rioja
2x 95089206649	TIBBO	Dry+ cushion set, LINEN ebony	2x 00098025125	VID	Carpet solid 300 x 400 cm, canvas
2x 00089040205	TIBBO	Coffee table M, teak			

### RECOMMENDED DECO CUSHIONS:

3x 95050081647	Deco cushion	40 x 40 cm, LINEN flax
1x 95050081648	Deco cushion	40 x 40 cm, LINEN umbra
2x 95050081649	Deco cushion	40 x 40 cm, LINEN ebony
2x 95050082648	Deco cushion	50 x 50 cm, LINEN umbra
2x 95050084647	Deco cushion	60 x 60 cm, LINEN flax



# TIBBO DINING

Design by EDWARD BARBER & JAY OSGERBY



TIBBO Dining Setting 01

- 4x 00089001122 TIBBO Armchair, teak
- 4x 95089202675 TIBBO Dry+ cushion, Kvadrat® Patio220
- 1x 00089085205 TIBBO Dining table Ø 150 cm, teak



TIBBO Dining Setting 02

- 6x 00089001122 TIBBO Armchair, teak
- 6x 95089202684 TIBBO Dry+ cushion, MAR nori
- 1x 00089055205 TIBBO Dining table 103 x 278 cm, teak
- 1x 00098025125 VID Carpet solid 300 x 400 cm, canvas
- 1x 00073062168 DALA Lantern L, bahamas
- 1x 00073061168 DALA Lantern M, bahamas
- 4x 00073060168 DALA Lantern S, bahamas



TIBBO Dining Setting 03

- 8x 00089001122 TIBBO Armchair, teak
- 8x 95089202651 TIBBO Dry+ cushion, LINEN sand
- 1x 00089012205 TIBBO Bench, teak
- 1x 00089045205 TIBBO Dining table 103 x 338 cm, teak



TIBBO Dining Setting 04

- 6x 00089001122 TIBBO Armchair, teak
- 6x 95089202472 TIBBO Dry+ cushion, NATURA taupe
- 1x 00607062205 WA Dining table 100 x 200 cm, black pepper/teak

WA

Design by TOAN NGUYEN



Dining table 100 x 250 cm, lipari/teak



# WA

Design by TOAN NGUYEN

## Typology

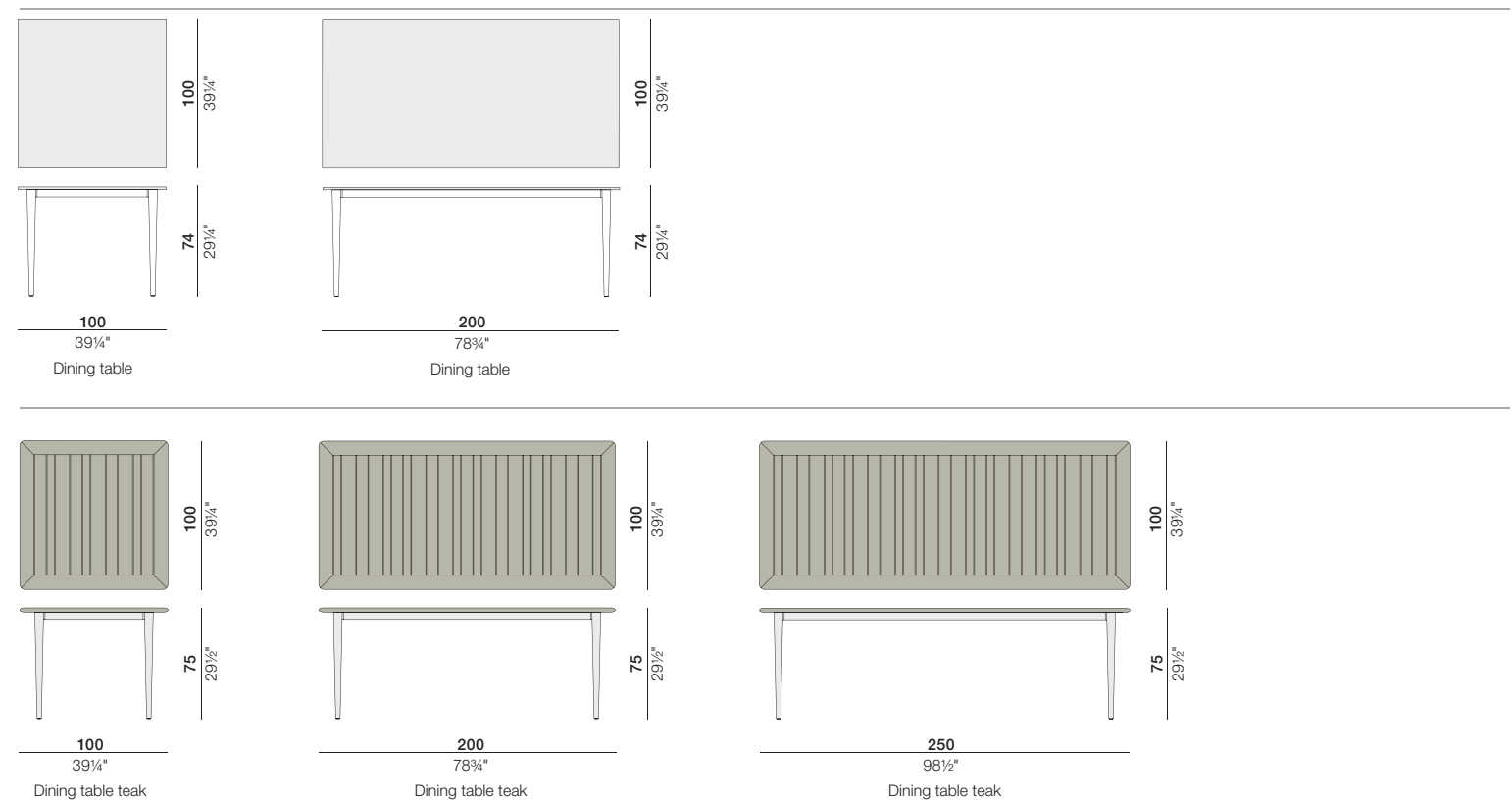

## Materials

### Base

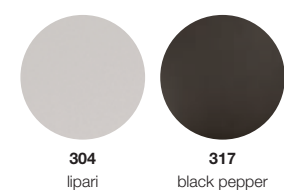

### Tabletops

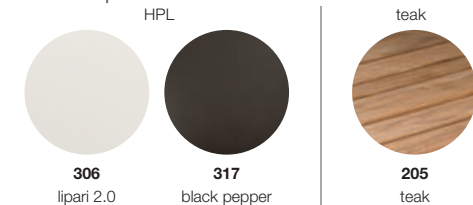

## Complementary chairs

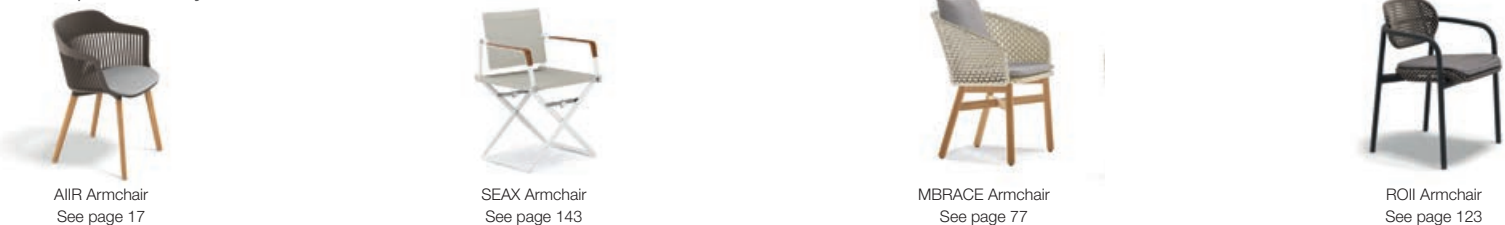

### RRP/UPP

#### DINING TABLE Esstisch

Teak  
 100 x 100 cm  
 39 1/4" x 39 1/4"  
 39,5 kg  
 65 lbs

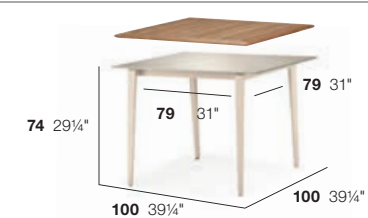
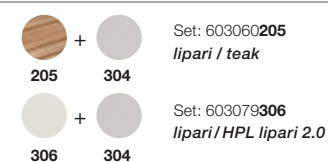

HPL  
 100 x 100 cm  
 39 1/4" x 39 1/4"  
 34 kg  
 75 lbs

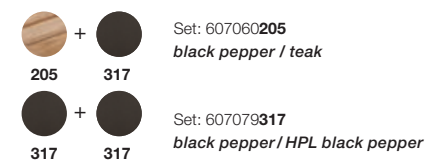

56057075000

#### DINING TABLE Esstisch

Teak  
 100 x 200 cm  
 39 1/4" x 78 3/4"  
 44 kg  
 97 lbs

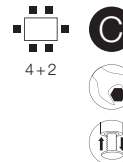
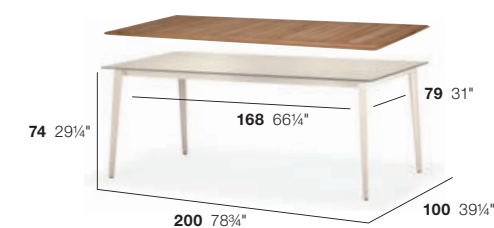
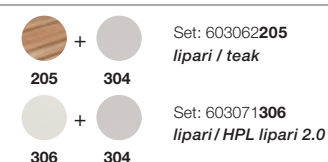

HPL  
 100 x 200 cm  
 39 1/4" x 78 3/4"  
 44 kg  
 97 lbs

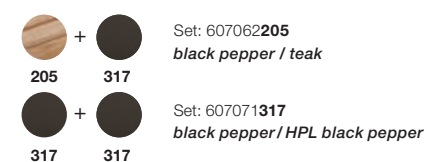

56057065000

#### DINING TABLE Esstisch

100 x 250 cm  
 98 1/2" x 39 1/4"  
 49,5 kg  
 109 lbs

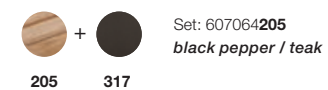
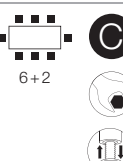
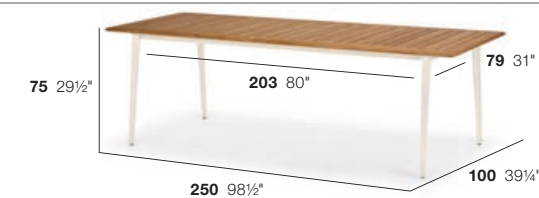
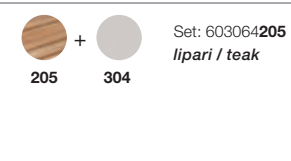

56600064000

### EN MATERIAL

The WA table is available with a high-pressure laminate (HPL) top and a teak top. HPL is a material that is highly resistant to impact, mechanical stress, moisture and steam. To clean the HPL tabletop, use a soft cloth, warm water and a gentle cleanser, if needed. The teak tabletop is made of premium teak. Wash using DEDON teak cleaner. To retain the golden-brown color of unweathered teak, we recommend applying DEDON teak oil at least once in every six months. The legs consist of die-cast powder coated aluminum. Clean the legs with a soft cloth and warm water.

### DE MATERIAL

Der WA Tisch ist verfügbar mit einer HPL-Platte sowie einer Teak-Tischplatte. HPL ist ein Material, das sich durch hohe Stoßfestigkeit und extreme Widerstandskraft gegen mechanische Einwirkungen, Feuchtigkeit und Dampf auszeichnet. Zur Reinigung der HPL-Tischplatte eignen sich ein warmes Tuch, warmes Wasser und bei Bedarf ein sanftes Reinigungsmittel. Die Teak-Tischplatte besteht aus hochwertigem Teakholz. Reinigen Sie das Teakholz mit DEDON Teak Reiniger. Um den ursprünglichen goldbraunen Farbton zu bewahren, tragen Sie mindestens alle sechs Monate das DEDON Teak Öl auf. Die Beine sind aus gegossenem pulverbeschichtetem Aluminium gefertigt. Einfach mit einem weichen Tuch und warmem Wasser zu reinigen.



LIGHTING & ACCESSORIES







# THE OTHERS

Design by STEPHEN BURKS



Lantern M, terra + optional set of eyes, midday | Statue LIKA + optional set of eyes, midnight | Lantern S, forest

## Typology

cm inch

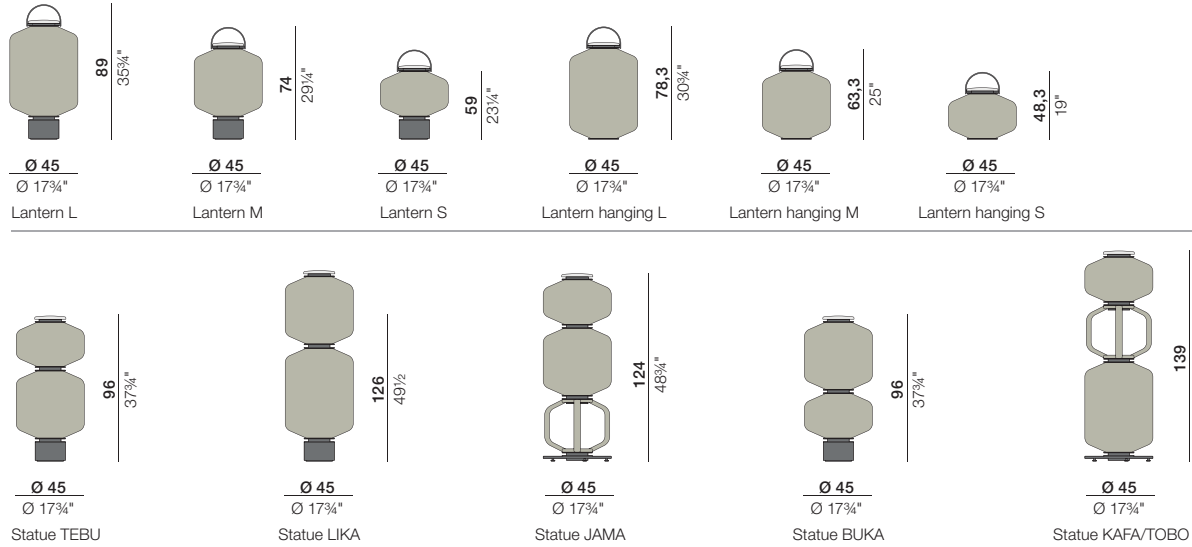

## Materials

<b>Fibers lantern S</b>  128 cloud 127 forest	<b>Fibers lantern M</b>  128 cloud 129 terra	<b>Fibers lantern L</b>  128 cloud 130 rock	<b>Further material</b>  Handmade acrylic eyes, mosaic style Marble base in nero marquina Teak spacer
--	---	--	---





RRP/UVF  
 LANTERN S  
 Laterne S

10,1 kg  
 23 lbs

Set **093010128** 230 V  
 Set **093015128** 120 V

**128**  
**127**

59 23¼"



Ø 45 Ø 17¾"  
 093010128

LED, C, IP64, Smartphone, Wheelchair, Angle

LANTERN M  
 Laterne M

10,6 kg  
 24 lbs

Set **093020128** 230 V  
 Set **093025128** 120 V

**128**  
**129**

74 29¼"



Ø 45 Ø 17¾"  
 093020128

LED, C, IP64, Smartphone, Wheelchair, Angle

LANTERN L  
 Laterne L

11,2 kg  
 25 lbs

Set **093030128** 230 V  
 Set **093035128** 120 V

**128**  
**130**

89 35"



Ø 45 Ø 17¾"  
 093030128

LED, C, IP64, Smartphone, Wheelchair, Angle

LANTERN HANGING S  
 Hängende Laterne S

3 kg  
 7 lbs

Set **093040128** 230 V  
 Set **093045128** 120 V

**128**  
**127**

48 19"



Ø 45 Ø 17¾"  
 093040128

LED, C, IP64, Smartphone, Wheelchair, Angle

LANTERN HANGING M  
 Hängende Laterne M

3,6 kg  
 8 lbs

Set **093050128** 230 V  
 Set **093055128** 120 V

**128**  
**129**

63 24¾"



Ø 45 Ø 17¾"  
 093050128

LED, C, IP64, Smartphone, Wheelchair, Angle

LANTERN HANGING L  
 Hängende Laterne L

4,2 kg  
 10 lbs

Set **093060128** 230 V  
 Set **093065128** 120 V

**128**  
**130**

78 30¾"



Ø 45 Ø 17¾"  
 093060128

LED, C, IP64, Smartphone, Wheelchair, Angle

OPTIONAL SET OF EYES  
 Optionales Augenset

midday  
 093092002



midnight  
 093092003



STATUE TEBU  
 Statue TEBU

Ø 45 cm  
 12,9 kg  
 Ø 17¾"  
 29 lbs

Set **093100000** 230 V  
 Set **093105000** 120 V

96 cm 37¾"

Ø 45 cm  
 Ø 17¾"

LED, IP64, Wheelchair, Angle

STATUE BUKA  
 Statue BUKA

Ø 45 cm  
 12,9 kg  
 Ø 17¾"  
 29 lbs

Set **093130000** 230 V  
 Set **093135000** 120 V

96 cm 37¾"

Ø 45 cm  
 Ø 17¾"

LED, IP64, Wheelchair, Angle

STATUE LIKA  
 Statue LIKA

Ø 45 cm  
 14,1 kg  
 Ø 17¾"  
 31 lbs

Set **093110000** 230 V  
 Set **093115000** 120 V

128 cm 49½"

Ø 45 cm  
 Ø 17¾"

LED, IP64, Wheelchair, Angle

STATUE JAMA  
 Statue JAMA

Ø 45 cm  
 13,2 kg  
 Ø 17¾"  
 29 lbs

Set **093120000** 230 V  
 Set **093125000** 120 V

124 cm 48¾"

Ø 45 cm  
 Ø 17¾"

LED, IP64, Wheelchair, Angle

STATUE TOBO  
 Statue TOBO

Ø 45 cm  
 13,9 kg  
 Ø 17¾"  
 31 lbs

Set **093140000** 230 V  
 Set **093145000** 120 V

139 cm 54¾"

Ø 45 cm  
 Ø 17¾"

LED, IP64, Wheelchair, Angle

STATUE KAFA  
 Statue KAFA

Ø 45 cm  
 13,5 kg  
 Ø 17¾"  
 30 lbs

Set **093150000** 230 V  
 Set **093155000** 120 V

139 cm 54¾"

Ø 45 cm  
 Ø 17¾"

LED, IP64, Wheelchair, Angle

**EN FUNCTION**  
 This lighting object is a decorative element for outdoor and indoor use and features a warm white correlated color temperature (2700 Kelvin). LED-Module: The LED-module has an ingress protection marking by IP64, which means it is dustproof, splashproof and therefore fully suitable for outdoor use. Energy efficiency EEC A+. The LED module can be charged in two ways: by solar panel or power adapter. The luminaries contain built-in LED lamps that cannot be replaced. Supplied with a 230V standard plug (Europe) or 120V standard plug (USA).

**MATERIAL**  
 THE OTHERS components are made with DEDON Fiber, premium teak, Italian marble and acrylic mosaic. Clean teak using DEDON teak cleaner. To retain the golden-brown color of unweathered teak, we recommend applying DEDON teak oil at least once in every six months.

**DE FUNKTION**  
 Diese Leuchte ist ein dekoratives Objekt für den Innen- und Außenbereich mit einer warmweißen Farbtemperatur (2700 Kelvin). LED-Modul: Das LED-Modul hat die Schutzklasse IP64 gegen Eindringen von Wasser und Schmutz, ist also staubdicht und spritzwassergeschützt und somit absolut geeignet für den Einsatz im Außenbereich. Aufladen lassen sich die LED-Module auf zweierlei Arten: über Solarmodule oder ein Netzkabel. Energieeffizienzklasse EEK A+. Die Leuchten enthalten eingebaute LED-Lampen, die nicht ausgetauscht werden können. Lieferung mit 230V Standardstecker (Europa) oder 120V Standardstecker (USA).

**MATERIAL**  
 Die Elemente der THE OTHERS Kollektion bestehen aus DEDON-Faser, Premium-Teak, italienischem Marmor und Acrylmosaik. Reinigen Sie Teakholz-Elemente mit DEDON Teak Reiniger. Um den ursprünglichen goldbraunen Farbton zu bewahren, tragen Sie mindestens alle sechs Monate das DEDON Teak Öl auf.





# LOON

Design by SEBASTIAN HERKNER



Floor lamp L | Floor lamp S

## Typology

cm inch

## Material

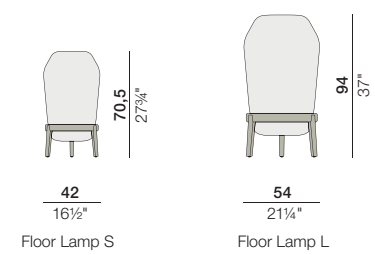

### RRP/UVP

#### FLOOR LAMP S Bodenleuchte S

Ø 42 cm  
3,2 kg  
Ø 16 1/2"  
8 lbs

70,5 27 3/4"



Ø 42 Ø 16 1/2"

Set **101010000** 230 V  
Set **101040000** 120 V

#### FLOOR LAMP L Bodenleuchte L

Ø 54 cm  
6,3 kg  
Ø 21 1/4"  
14 lbs

94 37"



Ø 54 Ø 21 1/4"

Set **101030000** 230 V  
Set **101050000** 120 V

### EN FUNCTION

This lighting object is a decorative element for outdoor and indoor use and features a warm white correlated color temperature (2700 Kelvin). LED-Module: The LED-module has an ingress protection marking by IP64, which means it is dustproof, splashproof and therefore fully suitable for outdoor use. Energy efficiency EEC A+. The luminaries contain built-in LED lamps that cannot be replaced. Supplied with a 230V standard plug (Europe) or 120V standard plug (USA). Charging is only possible via the supplied power adapter.

### MATERIAL

LOON consists of rotomolded polyethylene and a premium teak base. To clean the polyethylene body, use a soft cloth, warm water and a gentle cleanser, if needed. Clean teak using DEDON teak cleaner. To retain the golden-brown color of unweathered teak, we recommend applying DEDON teak oil at least once in every six months.

### DE FUNKTION

Diese Leuchte ist ein dekoratives Objekt für den Innen- und Außenbereich mit einer warmweißen Farbtemperatur (2700 Kelvin). LED-Modul: Das LED-Modul hat die Schutzklasse IP64 gegen Eindringen von Wasser und Schmutz, ist also staubdicht und spritzwassergeschützt und somit absolut geeignet für den Einsatz im Außenbereich. Energieeffizienzklasse EEK A+. Die Leuchten enthalten eingebaute LED-Lampen, die nicht ausgetauscht werden können. Lieferung mit 230V Standardstecker (Europa) oder 120V Standardstecker (USA). Das Aufladen ist nur über das mitgelieferte Netzteil möglich.

### MATERIAL

LOON besteht aus im Rotationsgussverfahren gefertigtem Polyethylen und einem Untergestell aus Teak. Zum Reinigen des Polyethylenkörpers verwenden Sie ein weiches Tuch, warmes Wasser und ein sanftes Reinigungsmittel, falls erforderlich. Reinigen Sie das Teakholz Untergestell mit DEDON Teak Reiniger. Um den ursprünglichen goldbraunen Farbton zu bewahren, tragen Sie mindestens alle sechs Monate das DEDON Teak Öl auf.





# BABYLON

Design by HARRY-PAUL



Stool / side table PE, incl. light

## Typology

cm inch

## Material

Ø 43  
17"



Ø 52,5  
20¾"

Side table / stool



Polyethylene  
off white

## RRP/UVP

STOOL / SIDE TABLE PE, INCL. LIGHT  
Hocker / Beistelltisch PE, inkl. Licht

Ø 52,5 cm  
5,3 kg  
Ø 20¾"  
12 lbs

Ø 43 Ø 17"



45 17¾"

Ø 52,5 Ø 20¾"

## EN FUNCTION

This lighting object is a decorative element for outdoor and indoor use and features a warm white correlated color temperature (2700 Kelvin). LED-Module: The LED-module has an ingress protection marking by IP64, which means it is dustproof, splashproof and therefore fully suitable for outdoor use. Energy efficiency EEC A+. The luminaries contain built-in LED lamps that cannot be replaced. Supplied with a 230V standard plug (Europe) or 120V standard plug (USA). Charging is only possible via the supplied power adapter.

## MATERIAL

BABYLON PE consists of rotomolded polyethylene.  
To clean the polyethylene body, use a soft cloth, warm water and a gentle cleanser, if needed.

## DE FUNKTION

Diese Leuchte ist ein dekoratives Objekt für den Innen- und Außenbereich mit einer warmweißen Farbtemperatur (2700 Kelvin). LED-Modul: Das LED-Modul hat die Schutzklasse IP64 gegen Eindringen von Wasser und Schmutz, ist also staubdicht und spritzwassergeschützt und somit absolut geeignet für den Einsatz im Außenbereich. Energieeffizienz: EEK A+. Die Leuchten enthalten eingebaute LED-Lampen, die nicht ausgetauscht werden können. Lieferung mit 230V Standardstecker (Europa) oder 120V Standardstecker (USA). Das Aufladen ist nur über das mitgelieferte Netzteil möglich.

## MATERIAL

BABYLON PE ist aus rotationsgussgefertigtem Polyethylen (PE) hergestellt.  
Zum Reinigen des Polyethylenkörpers verwenden Sie ein weiches Tuch, warmes Wasser und ein sanftes Reinigungsmittel, falls erforderlich.





# BABYLON PLANTER

Design by HARRY-PAUL



## Typology

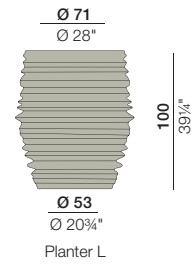

RRP/UVP

Planter L

PLANTER L  
Übertopf L

Ø 87 cm  
30 kg  
Ø 34 1/4"  
66 lbs



100 39 1/4"

Ø 53 Ø 20 3/4"  
053084300

## Material



300  
chalk

INTERIOR VIEW  
Innenansicht

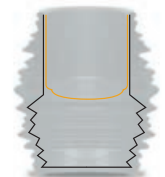

45 17 3/4"

98 38 1/2"

### EN MATERIAL

The BABYLON Planter is a dual-walled planter the volume of which can vary depending on the size of the plant. Made of rotomoulded polyethylene (PE): 100% approved for outdoor use, easy to maintain, 100% recyclable, light yet robust at the same time.

To clean the surface, use a soft cloth, warm water and a gentle cleanser, if needed.

### DE MATERIAL

Der BABYLON Planter ist ein doppelwandiger Übertopf, dessen Volumen je nach Pflanzengröße variiert werden kann. Aus rotationsguss gefertigtem Polyethylen (PE) hergestellt: 100% Outdoor-Verwendung, einfach zu pflegen, gleichzeitig leicht und widerstandsfähig, 100% recyclingfähig. Zum Reinigen der Oberfläche verwenden Sie ein weiches Tuch, warmes Wasser und ein sanftes Reinigungsmittel, falls erforderlich.



For more BABYLON products see page 23

# VID

Design by DEDON DESIGN STUDIO



## Typology

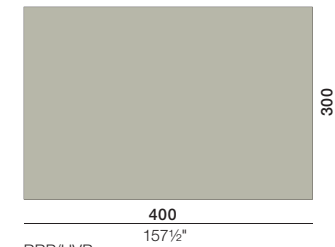

RRP/UVP

CARPET FRINGES  
Teppich FRINGES

200 x 300 cm  
78 3/4" x 118"

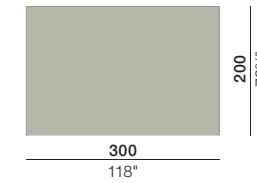

300 118"

## Materials

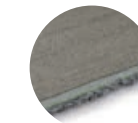

125  
FRINGES  
canvas

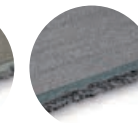

124  
FRINGES  
light gray

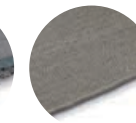

125  
SOLID  
canvas

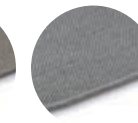

124  
SOLID  
light gray

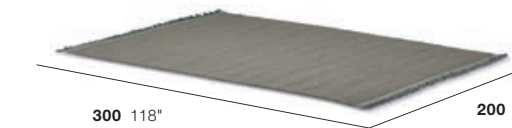

098030125



098030124

098030

CARPET SOLID  
Teppich SOLID

200 x 300 cm  
78 3/4" x 118"



300 118"

200 78 3/4"

098020125

098020124

098020

CARPET SOLID  
Teppich SOLID

300 x 400 cm  
118" x 157 1/2"



400 157 1/2"

300 118"

098025125

### EN MATERIAL

VID is handwoven and consists of 100% polypropylene. Designed and treated for outdoor use, it is UV- and weather-resistant. We recommend to lift the carpet periodically to let it dry.

Vacuum-clean the carpet at least once a week in order to prolong its life and maintain its colors. For ordinary cleaning, we recommend vacuuming with a soft brush head. For targeted cleaning, use a solution of cold water and a neutral detergent.

### DE MATERIAL

VID ist handgewebt und besteht aus 100% Polypropylen. Der Teppich ist witterungsbeständig, hat eine hohe UV-Resistenz und eignet sich für den Einsatz im Außenbereich. Wir empfehlen, den Teppich regelmäßig anzuheben, um ihn vollständig zu trocknen.

Saugen Sie den Teppich mindestens einmal in der Woche mit einem weichen Bürstenkopf ab. So behält er seine ursprüngliche Farbe. Um einzelne Flecken zu entfernen, nutzen Sie kaltes Wasser und ein neutrales Reinigungsmittel.

# DALA PLANTER & LANTERN

Design by STEPHEN BURKS



Lantern M, cuba | Lantern M, bahamas | Planter M, ibiza

## Typology

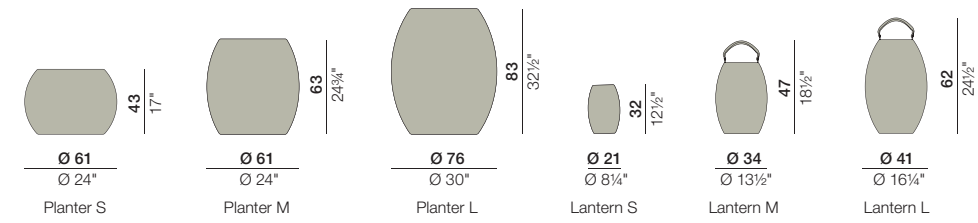

## Materials

### Combinations

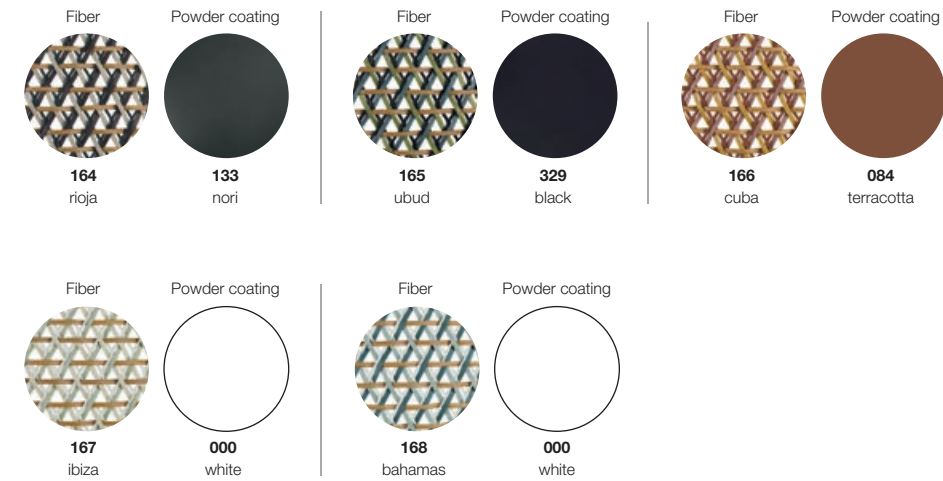

For more DALA products see page 38

RRP/UDP

PLANTER S  
Übertopf S

Ø 61 cm  
4,8 kg  
Ø 24"  
11 lbs

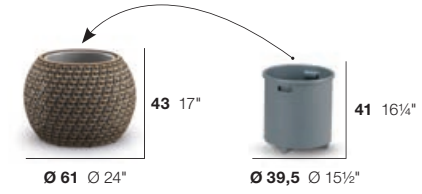
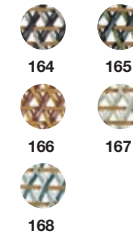

Set 073050164

073050

PLANTER M  
Übertopf M

Ø 61 cm  
6,2 kg  
Ø 24"  
16 lbs

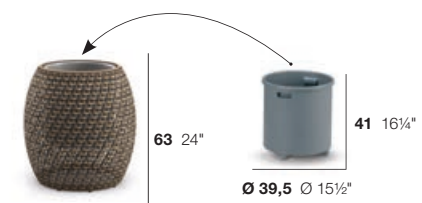

Set 073052164

073052

PLANTER L  
Übertopf L

Ø 76 cm  
7,2 kg  
Ø 30"  
18 lbs

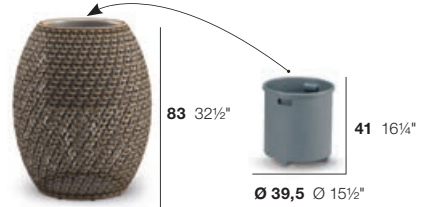
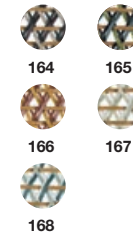

Set 073051164

073051

LANTERN S  
Laterne S

Ø 21 cm  
1 kg  
Ø 8 1/4"  
3 lbs

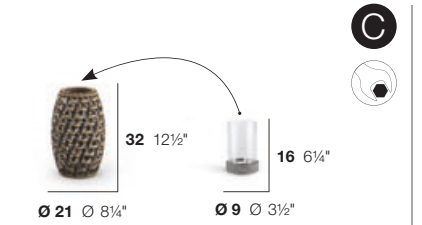

Set 073060164

073060

LANTERN M  
Laterne M

Ø 34 cm  
2 kg  
Ø 13 1/2"  
5 lbs

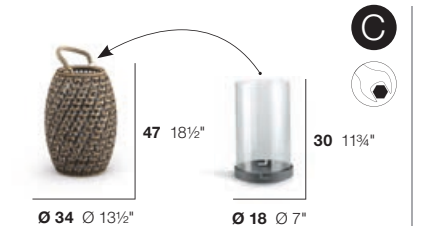
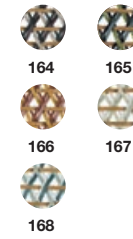

Set 073061164

073061

LANTERN L  
Laterne L

Ø 41 cm  
2,5 kg  
Ø 16 1/4"  
6 lbs

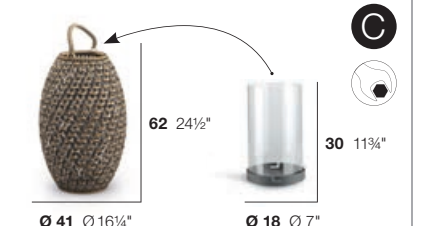

Set 073062164

073062

### EN MATERIAL

DALA planter and lantern consist of DEDON fiber woven over a powder coated aluminum frame. To clean the surface, use a soft cloth or brush, warm water and a gentle cleanser if needed.

The removable inner planter consists of rotomolded polyethylene.

The removable candle holder consists of a metal candle plate and a plastic tube. For the small DALA lantern (height 32 cm / 12 1/2"), use only a block candle with a maximum height of 8 cm / 4 1/2" and a maximum diameter of 11 cm / 3 1/4". For the medium and large DALA lanterns (heights 47 cm / 18 1/2" and 62 cm / 24 1/2"), use only a block candle with a maximum height of 22 cm / 8 3/4" and a maximum diameter of 17 cm / 6 3/4".



HANGER FOR LANTERN Ø 21 CM / Ø 12 1/2"  
Aufhängung für Laterne Ø 21 cm / Ø 12 1/2"



073091000



HANGER FOR LANTERN Ø 34 CM / Ø 18 1/2" and Ø 41 CM / Ø 24 1/2"  
Aufhängung für Laterne Ø 34 cm / Ø 18 1/2" und Ø 41 cm / Ø 24 1/2"



073092000



### DE MATERIAL

Die Übertöpfe und Laternen der DALA Kollektion bestehen aus DEDON-Faser, die auf einen pulverbeschichteten Aluminiumrahmen geflochten ist. Um die Oberfläche zu reinigen, benutzen Sie ein weiches Tuch oder eine weiche Bürste, warmes Wasser und, falls nötig, ein sanftes Reinigungsmittel.

Der herausnehmbare innere Behälter wurde in Rotationsgusstechnik aus Polyethylen gefertigt. Der herausnehmbare Kerzenhalter besteht aus einem Kerzenteller aus Metall und einem Kerzenschutz aus Kunststoff. Die Kerzen sollten für die kleine DALA Laterne (Höhe 32 cm / 12 1/2") eine Höhe von 11 cm / 4 1/2" und einen Durchmesser von 8 cm / 3 1/4" nicht überschreiten. Die Kerzen für die DALA Laternen mittlerer und großer Größe (Höhe 47 cm / 18 1/2" und 62 cm / 24 1/2") sollten nicht höher als 17 cm / 8 3/4" sein und einen maximalen Durchmesser von 17 cm / 6 3/4" nicht überschreiten. Verwenden Sie bitte ausschließlich Blockkerzen.



# MINI NESTREST

Design by DANIEL POUZET & FRED FRETY



## Typology

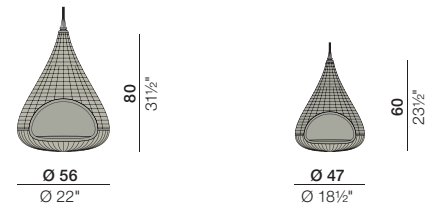

cm inch

## Fabric Information (see page 224)

Cushions for this collection are only available in fabric 472 (Cat. A).  
Kissen für diese Kollektion sind nur im Stoff 472 (Kat. A) verfügbar.

## Materials

### Combinations

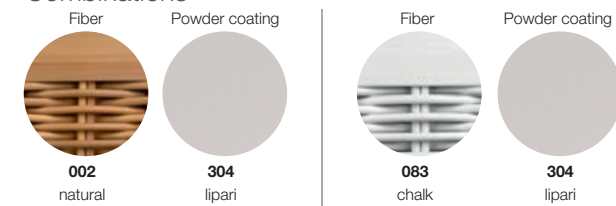

RRP/UVP

MINI NESTREST, DECORATION ITEM  
Mini Nestrest, Dekorationsartikel

Ø 47 cm  
Ø 18½"  
2,5 kg  
6 lbs

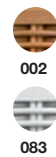

60 23½"

Ø 47 Ø 18½"

090021002



SEAT CUSHION  
Sitzkissen  
COM 0,53 M



090021

MINI NESTREST, DECORATION ITEM  
Mini Nestrest, Dekorationsartikel

Ø 56 cm  
Ø 22"  
3,5 kg  
8 lbs



80 31½"

Ø 56 Ø 22"

090022002



SEAT CUSHION  
Sitzkissen  
COM 0,63 M



090022

95090021472

95090022472

# LA MALLE

Design by LORENZA BOZZOLI & THE KINGS



## Typology

cm inch

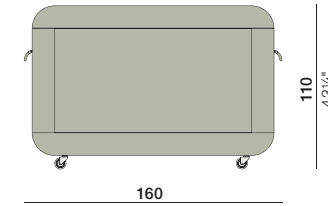

RRP/UVP

CUSHIONS TRUNK XL  
Kissenruhe XL

66,5 kg  
147 lbs

072010

EN FUNCTION

Opening and closing of the lid is assisted by pneumatic springs. All trunks are designed for short-term storage of DEDON cushions and pillows. Ensure the cushions are completely dry before storing them in the trunk. The trunk can be used in covered outdoor areas as well as indoors.

MATERIAL

LA MALLE features pneumatic springs for the lid, easy-rolling wheels, breathable Tensiline® fabric for the interior and specially designed ventilation to keep it moisture-free. To clean the surface, which is made of DEDON fiber, use a soft cloth or brush, warm water and a gentle cleanser, if needed.

## Material

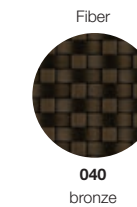

072010040

INTERIOR DIMENSIONS (W x H x D)  
Abmessungen innen (B x H x T)

152 x 82 x 87 cm  
59¾" x 32¼" x 34¼"

DE FUNKTION

Das Öffnen und Verschießen des Deckels wird durch Gasdruckfedern unterstützt. Alle Truhen dienen einem kurzzeitigen Verstauen der DEDON-Kissen und Polster. Stellen Sie sicher, dass die Kissen vollständig trocken sind, bevor Sie sie in die Truhe legen. Die Truhe ist im überdachten Außenbereich sowie im Innenbereich einsetzbar.

MATERIAL

Die LA MALLE Kissenruhe XL besitzt Leichtlaufrollen, atmungsaktives Tensiline® Innenfutter und eine speziell gestaltete Belüftung, die das Innere von Feuchtigkeit freihält. Umflochten ist die Truhe mit DEDON Faser. Um die Oberfläche der DEDON Faser zu reinigen, benutzen Sie ein weiches Tuch oder eine weiche Bürste, warmes Wasser und, falls nötig, ein sanftes Reinigungsmittel.



# REAV

Design by DEDON DESIGN STUDIO



Square M - cantilever, anthracite



# REAV

Design by DEDON DESIGN STUDIO

## Typology

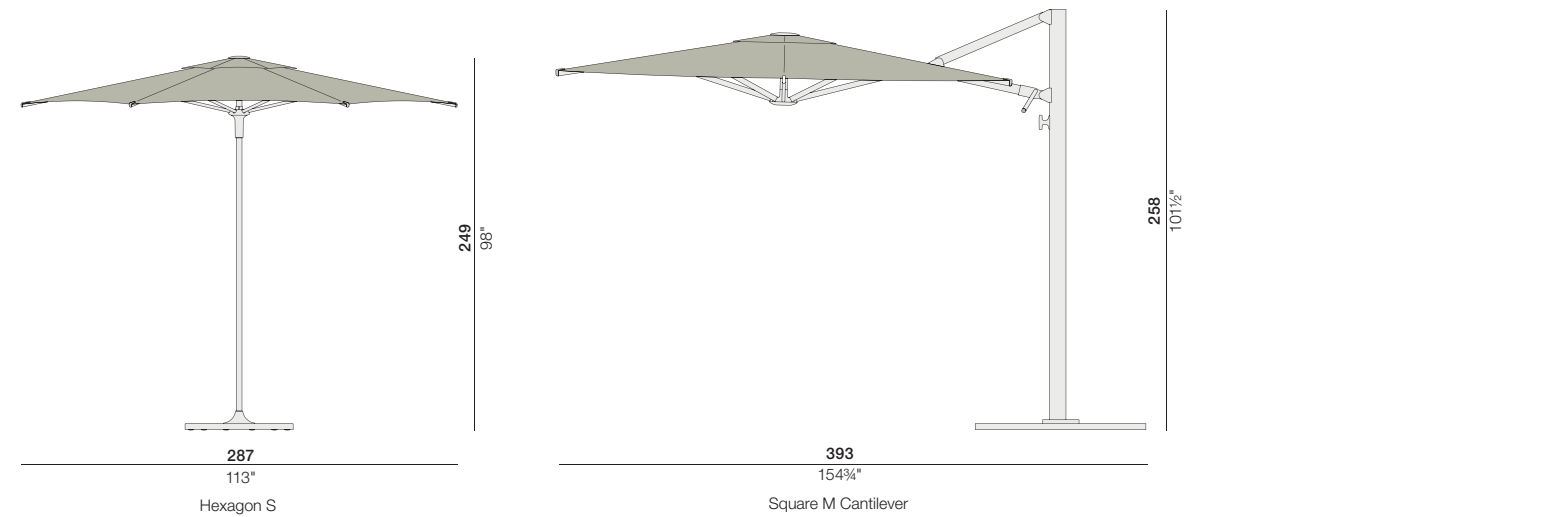

## Materials

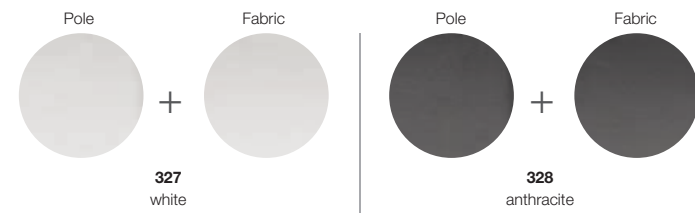

RRP/UVF

HEXAGON S

287 x 260 cm  
113" x 102 1/4"

Base  
Ø 71,5 cm | Ø 28 1/4"  
79 kg | 174 lbs



287 113"  
Set 106026328

287 113"



included

106026

SQUARE M – CANTILEVER

300 x 300 cm  
118" x 118"

Base  
5 x 113 x 133 cm | 2" x 44 1/2" x 44 1/2"  
262 kg | 578 lbs



393 154 3/4"  
Set 106058328

300 118"

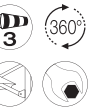

included

106058

SQUARE M – CANTILEVER

300 x 300 cm  
118" x 118"



393 154 3/4"  
Set 106096328

300 118"

IN-GROUND MOUNTING KIT  
Montagesatz zur Bodenbefestigung im Erdboden

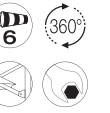
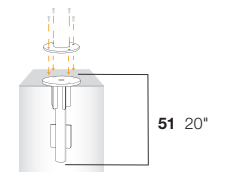

included

106096

SQUARE M – CANTILEVER

300 x 300 cm  
118" x 118"



393 154 3/4"  
Set 106097328

300 118"

CONCRETE MOUNTING KIT  
Montagesatz zur Bodenbefestigung im Betonboden

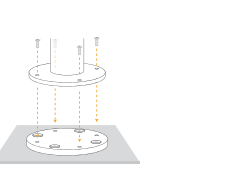

included

106097



EN WIND GRADE

The REAV collection is available for wind grade 3 (12-19 km/h/7.5–12 mph) or wind grade 6 (39-49 km/h/24–30 mph). See icon for number of wind force.

To ensure stability at wind grades up to 6 (39-49 km/h/24-30 mph), items for this wind grade are only available with a ground mounting kit. Safety instructions for ground mounting can be found in the assembly instructions. It is the responsibility of the customer to provide a safe and suitable foundation.

MAINTENANCE

In locations close to the ocean or sea, frames should be rinsed regularly with fresh water. If the parasol is dismantled for storage, the canopy should be cleaned, allowed to air-dry and stored in a dry, well-ventilated area. To maintain the appearance of the parasol and the covering, the components should be cleaned carefully with water, mild soap and a soft cloth or pad.



DE WINDSTÄRKE

Die REAV Sonnenschirme sind für zwei verschiedenen Windstärken erhältlich: Windstärke 3 (12-19 km/h / 7.5 - 12 mph) und Windstärke 6 (39-49 km/h/24–30 mph). Die Windstärke ist mit einem Symbol neben dem Produkt angegeben.

Um die Standsicherheit bei Windstärken bis 6 (39-49 km/h / 24–30 mph) zu gewährleisten, sind die Schirme für Windstärke 6 ausschließlich mit einem Bodenmontagesatz verfügbar. Sicherheitshinweise für die Bodenmontage finden Sie in der Montageanleitung. Es obliegt dem Kunden für einen geeigneten, sicheren Untergrund zu sorgen.

PFLEGE

An Standorten in der Nähe des Meeres sollten die Rahmen regelmäßig mit frischem Wasser abgespült werden. Wenn der Sonnenschirm zur Aufbewahrung abgebaut wird, sollte die Bespannung gereinigt und an der Luft getrocknet werden sowie an einem trockenen, gut belüfteten Ort gelagert werden. Um das Aussehen des Sonnenschirms zu erhalten, sollte der Ständer vorsichtig mit Wasser und Seife und einem weichen Tuch oder Schwamm gereinigt werden. Um das Aussehen des Sonnenschirms und der Bespannung zu erhalten, sollten die Komponenten vorsichtig mit Wasser, Seife und einem weichen Tuch oder Schwamm gereinigt werden.



INFORMATION

Spirit  
of Place







## EN CUSTOMIZATION OPTIONS FOR PROFESSIONALS

DEDON manufactures its weather-proof fiber and award-winning furniture at its own production facilities in Northern Germany and the Philippines. This ensures the highest levels of craftsmanship, quality and innovation while enabling DEDON to develop customized solutions for architects and contract professionals:

- Choose the perfect color for DEDON Fiber, powder coating and other materials.
- Select from a variety of high-end outdoor fabrics or propose your own fabric.
- Take advantage of custom cushion manufacturing and, exclusively for contract use, DEDON's special slim cushions, available on demand.

Contact [customer-service@dedon.de](mailto:customer-service@dedon.de) to discover DEDON's full range of customization options.

## DE INDIVIDUALISIERUNGSMÖGLICHKEITEN FÜR OBJEKTPARTNER

DEDON produziert seine wetterfeste Faser und preisgekrönten Outdoor-Möbel in eigenen Fertigungsanlagen in Norddeutschland und auf den Philippinen. Damit bietet DEDON ein Höchstmaß an handwerklichem Können, Qualität und Innovation und ist in der Lage, individuelle Lösungen für Architekten und Einrichtungsprofis bereitzustellen:

- Wählen Sie die perfekte Farbe für die DEDON-Faser, Pulverbeschichtungen und weitere Materialien aus.
- Wählen Sie aus einer Vielzahl von exklusiven DEDON-Stoffen für den Außenbereich oder lassen Sie Ihren eigenen Stoff verarbeiten.
- Nutzen Sie die Möglichkeit, individuelle Polster extra für Ihren Auftrag herstellen zu lassen. DEDONs spezielle, schlanke Polster sind auf Anfrage erhältlich.

Wenden Sie sich an [customer-service@dedon.de](mailto:customer-service@dedon.de), um mehr über die gesamte Bandbreite an Individualisierungsmöglichkeiten zu erfahren.

# WARRANTY

Collection	Residential 5 years Contract 5 years	Residential 5 years Contract 5 years	Residential 5 years Contract 3 years	Residential 2 years Contract 2 years	Residential 2 years Contract 2 years	Residential 2 years Contract 2 years	Residential 2 years Contract 2 years	Residential 2 years Contract 2 years	Residential 2 years
	Aluminum	Woven frame	Teak Stainless steel	Belt Rope Sling	Ceramic Glaze Glass + HPL Marble	LED lights	Fabric Cushion insert	Injection molded polypropylene	Gas spring
AHNSA	■	■			■		■		
AIR			■				■	■	
BABYLON					■		■		
BABYLON PE						■		■	
BABYLON PLANTER									
BELLMONDE	■	■			■		■		
BRIX							■		
DALA	■	■			■		■		
DALA PLANTER & LANTERN	■	■							
IZON	■				■				
KIDA	■	■		■			■		
LA MALLE	■	■	■	■					■
LEAF	■	■							
LOON						■		■	
LOUNGE	■	■			■		■		■
MBARQ	■	■		■			■		
MBRACE	■	■	■		■		■		
MINI NESTREST	■	■		■			■		
MU	■	■		■	■		■		■
NESTREST	■	■		■			■		
ORBIT	■	■		■			■		
PANAMA	■	■			■		■		
PAROS	■	■					■		
PORCINI	■	■		■	■				
REAV	2 years	■							
RILLY	■	■		■			■		
ROII	■	■					■		
SATELLITE	■				■				
SEALINE	■	■	■	■	■		■		
SEASHELL	■	■					■		
SEAX	2 years						■		
SWINGREST	■	■		■			■		
TANGO	■	■			■		■		■
THE OTHERS	■	■	■		■	■			
TIBBO	■	■	■	■			■		
VID							■		
WA	■		■		■				

## EN 2022 WARRANTY TERMS

DEDON warrants to the original purchaser that our product is free from defective materials and workmanship under its intended reasonable use. The warranty period begins with the sale of product to the end customer. The applicable warranty period for the individual collections and materials is shown in the overview printed on p. 202. The warranty is non-transferrable, and is applicable to the original purchaser only. Proof of purchase will be required.

Any product believed to be of faulty materials or workmanship should be reported to DEDON as soon as reasonably possible. Following DEDON's assessment, any fault found and covered by this warranty will be rectified by the replacement or repair of the faulty part or product. DEDON will determine whether to replace or repair a faulty part or product. If deemed necessary to return a product for repair, DEDON will arrange for it to be returned to us via our choice of transit, and sent back to the original purchaser, free of charge. Circumstances may dictate the local repair is best course of action. No returns are accepted without prior written authorization from DEDON. The product must not have been misused or handled carelessly, nor have been damaged, neglected or used in abnormal conditions. The product must not have been modified, altered in any way, or repaired by anyone other than a member of DEDON staff or their appointed representatives.

The warranty will be valid only if proper maintenance and cleaning have been carried out in accordance with DEDON's aftercare instructions. This warranty does not apply to normal wear and tear caused by regular use or the passage of time. Damage such as dents, scratches or small chips in the paintwork arising from use

are not covered by this warranty. Marks and/or tears to fabrics or fibers that have happened during normal use are not covered by this warranty. Small cracks, which may appear in the end grain of teak when exposed to the elements, and any change of appearance due to usual weathering and/or changes in wood texture are considered natural for teak outdoor furniture and are not covered by this warranty. Wheels and foot caps are excluded from the general warranty. The Sling / Strap / Rope warranty covers against tearing, discoloration, fading or change in shade of colors. Normal sagging is to be expected as a result of use and is not covered by this warranty. Due to the nature of the planks used to create raw table tops, any splits, cracks in the end grain, hollow knots, twisting of timber over time, or degradation of the sapwood when outdoors are considered natural for thick-plank, teak outdoor furniture and are not covered by this warranty. This guarantee takes effect in addition to the statutory or otherwise contractually agreed warranty rights of the purchaser vis-à-vis the Seller (DEDON or DEDON Dealer) in question. The guarantee does not give rise to further entitlements on the part of the purchaser, especially for damage compensation.

### REPORTING OF COMPLAINTS

In order to look in to complaints/warranty issues, DEDON requires ALL of the following information provided in one single email: Photographs of the issue – general overview and close-ups of specific areas of damage and/or failure. Product code of item affected. The batch number and country of origin, which can be found on a small rectangular label located out of sight, usually on the underside of the item (for cushions, on the inside of the zipper;

for covers, on the label). Date of purchase: Please send a copy of the invoice as proof of the purchase date. Location of furniture, e.g. coastal / inland / swimming pool. Brief description of the damage and how the damage occurred.

Please always use a reference, i.e. a customer number in the title of the email, so that it is easy to track. Potential claims can be processed only if DEDON receives all necessary data. Once all of the above information has been received, we will review the case and advise in due course.

### RETURNS POLICY

Written authorization must be obtained from DEDON prior to returning any physical products. Products returned without prior written authorization will be refused. DEDON accepts the return of a product only in cases of a manufacturer's defect. Products that were authorized to be sent to DEDON but show damage that is obviously due to improper use or storage of the product, damage resulting from normal wear and tear in the course or normal use of the product, or other damages that are not due to a manufacturer's defects will be returned to the sender at the sender's expense. DEDON reserves the right, in the event of rejection of a complaint, to pass on to the sender any freight costs incurred by DEDON as well as fees for processing and inspection of products that are subject to an unjustified complaint. Returned products are inspected by our Quality Control Department and replaced or repaired if the damage is a result of a manufacturer's defect. If it is determined not to be a manufacturer's defect, the customer, along with the Quality Control Department, will decide what further action to take.

## DE GARANTIEBEDINGUNGEN 2022

DEDON garantiert dem ursprünglichen Käufer, dass die Materialien und die Verarbeitung des Produkts einwandfrei sind, soweit das Produkt bestimmungsgemäß und angemessen eingesetzt wird. Der Garantiezeitraum beginnt mit dem Verkauf des Produkts an den Endkunden. Die jeweils geltende Garantiezeit für die einzelnen Kollektionen und Materialien ergibt sich aus der auf S. 202 abgedruckten Übersicht.

Die Garantie ist nicht übertragbar und sie gilt nur für den ursprünglichen Käufer. Ein Kaufnachweis muss vorgelegt werden. Wenn Sie der Ansicht sind, dass die Materialien oder die Verarbeitung Ihres Produkts Grund zur Beanstandung geben, sollten Sie DEDON so schnell wie möglich darüber informieren. Sollte DEDON bei der Prüfung feststellen, dass ein Fehler vorliegt, der von dieser Garantie umfasst wird, wird das betreffende Teil oder Produkt ersetzt oder repariert. DEDON entscheidet nach eigenem Ermessen, ob ein fehlerhaftes Teil oder Produkt ersetzt oder repariert wird. Wenn entschieden wird, dass ein Produkt zu Reparaturzwecken zurückgesendet werden muss, so wird DEDON organisieren, dass es kostenfrei mit dem Transportmittel seiner Wahl zu DEDON und anschließend zurück zum Kunden transportiert wird. Unter Umständen kann eine Reparatur vor Ort die beste Lösung sein. Wir nehmen keine Rücksendungen an, die nicht vorher schriftlich durch DEDON freigegeben wurden.

Die Garantie gilt nicht für Schäden aufgrund von unsachgemäßer oder unachtsamer Behandlung, durch mutwillige Beschädigung oder im Fall einer Vernachlässigung oder Nutzung des Produkts unter ungewöhnlichen Umständen. Das Produkt darf nicht modifiziert oder auf irgendeine Weise verändert werden und Reparaturen dürfen nur von DEDON-Mitarbeitern oder ihren beauftragten Vertretern durchgeführt werden. Die Garantie gilt nur, wenn das Produkt entsprechend der Pflegehinweise von DEDON gewartet und gereinigt wurde. Die Garantie gilt nicht für normale Abnutzung durch die übliche Verwendung bzw. Alterungserscheinungen.

Die Garantie erstreckt sich nicht auf Dellen, Kratzer und kleine Abblätterungen der Lackierung, die bei der Verwendung entstanden sind. Die Garantie gilt nicht für Flecken und/ oder Risse im Stoff, die bei normaler Verwendung entstanden sind. Die Garantie gilt nicht für kleine Risse, die sich an den Enden von Teakholz-Teilen bilden können, wenn diese der Witterung ausgesetzt werden sowie für jegliche optische Veränderungen aufgrund normaler Witterung und/ oder Veränderungen an der Holzstruktur, da diese bei Teakmöbeln für den Außenbereich als natürlich anzusehen sind. Rollen und Fußkappen sind von dieser Garantie ausgeschlossen. Die Sling-/ Gurt-/ Seil-Garantie erstreckt sich auf Risse, Verfärbungen und das Verblässen bzw. die Veränderung von Farben, wobei ein normales Maß an Nachlassen des Materials bei Gebrauch zu erwarten und nicht durch die Garantie abgedeckt ist. Es liegt in der Natur des Holzes, das für naturbelassene Tischplatten verwendet wird, dass sich an den Enden des Holzes Risse oder Spalten bilden können, sich Hohlräume bilden oder das Holz sich im Laufe der Zeit zerzetzen sowie dass Splintholz sich beim Einsatz im Freien zersetzen kann. Diese Effekte gelten bei Möbeln aus dicken Teakholzbrettern für den Außenbereich als natürlich und werden nicht durch die Garantie abgedeckt. Die Garantie hat keine Auswirkung auf die gesetzlichen Gewährleistungsrechte, die daneben gegenüber dem Verkäufer (DEDON oder DEDON-Händler) bestehen bleiben. Die Garantie gewährt keine über die Erklärung hinausgehenden Rechte, insbesondere hinsichtlich möglicher Schadensersatzansprüche.

### REKLAMATION

Um Reklamationen/ Garantiefälle prüfen zu können, benötigt DEDON alle der folgenden Angaben gesammelt in einer E-Mail: Fotos des Schadens – Gesamtübersicht und Detailfotos der beschädigten bzw. fehlerhaften Bereiche. Den Produktcode des betroffenen Gegenstands, die Chargennummer und das Herkunftsland. Diese Angaben finden Sie auf dem kleinen rechteckigen Schild, das versteckt angebracht ist. Meist befindet es sich auf der Unterseite

des Produkts (bei Polstern auf der Innenseite des Reißverschlusses, bei Bezügen auf dem Etikett). Kaufdatum: Bitte schicken Sie uns eine Kopie der Rechnung als Beleg des Kaufdatums. Beschreibung des Standortes des Möbelstücks, z.B. an der Küste/ im Binnenland/ am Pool. Eine kurze Beschreibung des Schadens und wie er entstanden ist. Bitte geben Sie im Betreff der E-Mail stets einen Bezug an, wie z.B. eine Kundennummer. Das erleichtert uns die Zuordnung.

DEDON kann mögliche Ansprüche nur verarbeiten, wenn ALLE erforderlichen Angaben vorliegen. Sobald wir die oben angegebenen Informationen erhalten haben, werden wir den Fall prüfen und uns schnellstmöglich bei Ihnen melden.

### RÜCKSENDUNGEN

Bevor Sie Artikel an DEDON zurücksenden, ist unsere schriftliche Zustimmung zwingend erforderlich. Wir nehmen keine Produkte an, wenn die Rücksendung nicht im Vorfeld schriftlich freigegeben wurde. DEDON akzeptiert die Rücksendung eines Produkts nur, wenn ein Herstellungsfehler vorliegt. Produkte, die mit DEDONs Zustimmung zurückgeschickt wurden, aber Schäden aufweisen, die offensichtlich entstanden sind, weil das Produkt unsachgemäß benutzt oder gelagert wurde, oder sonstige Schäden, bei denen es sich nicht um Herstellungsfehler handelt, werden auf Kosten des Versenders zurückgeschickt. Im Fall einer Zurückweisung der Reklamation behält DEDON sich das Recht vor, dem Versender alle entstandenen Transportkosten sowie die Kosten für die Bearbeitung und Prüfung des Produkts in Rechnung zu stellen, die aufgrund einer ungerechtfertigten Beschwerde entstanden sind. Unsere Abteilung für Qualitätsprüfung begutachtet alle zurückgesendeten Produkte. Im Fall eines Herstellungsfehlers werden die Produkte ersetzt oder repariert. Wenn es sich bei einer Beschädigung nicht um einen Herstellungsfehler handelt, entscheiden der Kunde und die Abteilung für Qualitätsprüfung gemeinsam über das weitere Vorgehen.



# COPYRIGHT

## EN INTELLECTUAL PROPERTY RIGHTS AND COPYRIGHT

The DEDON Collections have been exclusively designed by our company or developed for us by designers. All designs are registered. DEDON GmbH holds the copyrights for all products. All products carry the "DEDON" label. Our trademark is protected by law. Any infringement of our rights will be prosecuted.

Beyond that, the following premium materials have been utilized:

- Tensiilne® is a registered trademark of Vertisol Internacional, S.R.L., Spain
- Ferrari Stamoid® is a registered trademark of The Serge Ferrari Group, France
- Monolite Ipergres® is a registered trademark of Laboratorio Pesaro S.r.l., Italy
- Teflon® is a registered trademark of E. I. du Pont de Nemours and Company, USA
- WeatherMax® is a registered trademark of Safety Components Fabric Technologies, Inc., USA
- Tempotest® is a registered trademark of Para' S.P.A., Italy
- RESOPAL® is a registered trademark of Wilsonart Engineered Surfaces, USA
- Sunbrella® is a registered trademark of Glen Raven, Inc., USA
- Kvadrat® is a registered trademark of KVADRAT A/S, Denmark

## DE GEWERBLICHE SCHUTZRECHTE UND URHEBERRECHT

Alle DEDON-Kollektionen wurden in unserem Unternehmen designt oder wurden exklusiv von Designern für uns entwickelt. Die Designs sind als eingetragene Geschmacksmuster geschützt. Die urheberrechtlichen Nutzungsrechte für alle Produkte liegen bei der DEDON GmbH. Alle Erzeugnisse sind mit unserem Markenzeichen „DEDON“ gekennzeichnet. Unser Markenzeichen ist gesetzlich geschützt. Jeder Verstoß gegen unsere Rechte wird von uns verfolgt.

Folgende Premiummaterialien werden darüber hinaus eingesetzt:

- Tensiilne® ist eine eingetragene Marke der Firma Firma Vertisol Internacional, S.R.L., Spanien
- Ferrari Stamoid® ist eine eingetragene Marke der Firma The Serge Ferrari SA, Frankreich
- Monolite Ipergres® ist eine eingetragene Marke der Firma Laboratorio Pesaro S.r.l., Italien
- Teflon® ist eine eingetragene Marke der Firma E. I. du Pont de Nemours and Company, USA
- WeatherMax® ist eine eingetragene Marke der Firma Safety Components Fabric Technologies, Inc., USA
- Tempotest® ist eine eingetragene Marke der Firma Para S.P.A., Italien
- RESOPAL® ist eine eingetragene Marke der Firma Wilsonart Engineered Surfaces, USA
- Sunbrella® ist eine eingetragene Marke der Firma Glen Raven, Inc., USA
- Kvadrat® ist eine eingetragene Marke der Firma KVADRAT A/S, Dänemark

© 2021 DEDON GmbH, Germany. The photographs featured in our catalogs and on our website are protected by copyright law and may not be reproduced without the express written permission of DEDON GmbH or DEDON, Inc.

Photographs of products appearing to be suspended in space, in an unnatural recreational manner or over water may be simulations created by professionals. Do not attempt to recreate these applications on your own.

© 2021 DEDON GmbH, Deutschland. Die Fotos in unseren Katalogen und auf unserer Website sind urheberrechtlich geschützt und dürfen ohne die ausdrückliche schriftliche Genehmigung der DEDON GmbH oder DEDON, Inc. nicht reproduziert werden.

Fotos von Produkten, die schwebend im Raum, auf unnatürliche Art und Weise kriert oder über Wasser schwebend erscheinen, können Simulationen sein, die von Fachleuten erstellt wurden. Versuchen Sie nicht, diese Anwendungen selbst nachzubilden.



# CAPTION

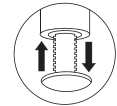

**The furniture is fitted with sliding mechanisms for height adjustment.**  
Das Möbel ist mit höhenverstellbaren Gleitern ausgestattet.



**This item is stackable. The digit in the icon shows the number of items that can be stacked.**  
Das Möbel ist stapelbar. Die Zahl im Symbol zeigt die Anzahl der stapelbaren Artikel.



**Rotatable by 360°.**  
Um 360° drehbar.



**The product is fitted with an LED lighting module.**  
Das Produkt ist mit einem LED Modul ausgestattet.



**A piece for securely connecting sections is included.**  
Inklusive Verbindungsstück "Connector" zur sicheren Verbindung einzelner Module.

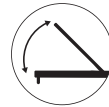

**The backrest mechanism allows the stepless adjustment of your furniture thanks to a gas spring. Please review the instruction manual!**  
Der Mechanismus der Rückenlehne erlaubt aufgrund der Verwendung einer Gasdruckfeder das stufenlose Verstellen des Möbels. Bitte beachten Sie die mitgelieferte Gebrauchsanleitung!



**This item offers a rocking feature.**  
Artikel mit Schaukelfunktion.



**There are two ways of charging the LED module: by solar panel or by power adapter.**  
Zwei Optionen zum Aufladen des LED Moduls: Solarpanel oder Ladekabel.



**The cushions come equipped with a cushion holder to keep them from sliding.**  
Die Kissen werden mit einem Kissenhalter geliefert, damit sie nicht verrutschen können.

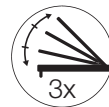

**This item is available with a hook-catching mechanism. See icon for number of hooks.**  
Dieser Artikel ist mit Stufenverstellung erhältlich. Das Symbol zeigt jeweils die Anzahl der Stufen.

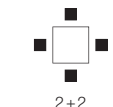

**The recommended number of chairs is only for the displayed collection and does not necessarily apply to chairs from other collections.**  
Die empfohlene Anzahl gilt allein für die Stühle dieser Kollektion und kann nicht auf kollektionsfremde Stühle übertragen werden.



**The LED module is charged using a power adapter.**  
Das LED Modul wird mit einem Ladekabel aufgeladen.



**The seat cushion on this item may be flipped.**  
Das Sitzkissen dieses Möbels ist wendbar.



**Assembly. Most DEDON tables, chairs and loungers require assembly.**  
Montage. Die meisten Stühle, Tische und Liegen von DEDON müssen zusammengebaut werden.



**A protective cover is available for this item.**  
Für dieses Möbel ist eine schützende Husse erhältlich.

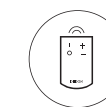

**Remote Control: To switch on the light, use the remote control or the button on the bottom of the LED module.**  
Fernbedienung: Sie können entweder die Fernbedienung verwenden, um die Leuchten einzuschalten, oder die Taste an dem LED Modul.

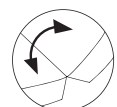

**The foldable cushion comes with handles for easy transportation.**  
Das faltbare Sitzkissen wird mit zwei Schlaufen geliefert, um den Transport zu erleichtern.



**DEDON EcoCycle Fiber**  
**This item is available with DEDON EcoCycle Fiber.**  
Dieses Produkt ist mit DEDON EcoCycle Faser erhältlich.

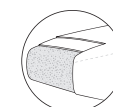

**Dry+ cushion construction**  
**Dry+ cushions are protected by a highly water-repellent interlayer up to 10,000 mm. This means that the material withstand a water column of 10 meters/32,81 ft.**  
Die Dry+ Kissen sind durch eine stark wasserabweisende innere Hülle mit einer Wassersäule von 10.000 mm geschützt. Dies bedeutet, dass das Material einer Wassersäule von zehn Metern standhalten kann.



**In addition to the on/off button, the remote control has a +/- function for adjusting the dimmer (8 steps).**  
Die Fernbedienung hat eine An- und eine Austaste sowie eine + und eine - Taste für die Dimm-Funktion (8 Stufen).



**The furniture is fitted with wheels.**  
Das Möbel ist mit Rollen ausgestattet.

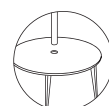

**This item is offered with a parasol hole.**  
Dieses Möbel hat ein Schirmloch.



**This item is available for wind grade 3 (12-19 km/h / 24 - 30 mph) or wind grade 6 (39-49 km/h / 7 - 12 mph).**  
**The wind force is displayed within the icon.**  
Das Produkt ist für Windstärke 3 (12-19 km/h) bzw. Windstärke 6 (39-49 km/h) geeignet. Die Windstärke ist mit einem Symbol angegeben.



**Products intended for contract use.**  
Das Möbel ist für den Einsatz im Contract Bereich geeignet.

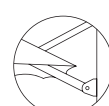

**This item can be adjusted in the angle of inclination.**  
Dieses Möbel kann in der Neigung angepasst werden.



# FIBER

## EN DEDON FIBER

Researched, developed, manufactured and quality-tested at our production facilities in Northern Germany, DEDON Fiber (HDPE) is unrivaled for its durability, weather-fastness and luxuriousness of color, texture and touch. Strong enough to withstand the harshest conditions yet supple enough to be woven into artful patterns by our master weavers, it has revolutionized outdoor furniture.

Because DEDON produces its fiber entirely in-house, we are able to work with our world-renowned designers to develop unique colors, textures and profiles. Our specialists monitor every new fiber we create, checking for resistance to UV-rays, salt water, pool water and extreme temperatures. The final product is non-toxic, non-polluting and fully recyclable. It is maintenance-free, easy to clean and recommended for indoor and outdoor use.

DEDON EcoCycle Fiber - Made with the help of nature 

Derived 90% from renewable plant-based resources, DEDON EcoCycle Fiber is an ecologically-conscious alternative to conventional, fossil-fuel-based products. It offers the same luxurious look and feel as standard DEDON Fiber, as well as the same unrivaled strength and weatherability.

With EcoCycle Fiber, DEDON proves the viability of an innovative sourcing procedure for renewable raw material. DEDON EcoCycle Fiber is made with polyethylene derived from sugarcane ethanol. Extruded at DEDON's own state-of-the-art production facilities in Northern Germany, EcoCycle Fiber meets the same exceptional standards of quality—and is protected by the same warranty—as DEDON Fiber. And like DEDON Fiber, it is fully recyclable through existing systems at the end of its product lifecycle.

## DE DIE DEDON-FASER

Die DEDON-Faser (HDPE) wird in unseren hochmodernen Produktionsstätten in Norddeutschland erforscht, entwickelt, hergestellt und auf ihre Qualität getestet. Sie ist konkurrenzlos in ihrer Strapazierfähigkeit und Wetterfestigkeit und zeichnet sich durch luxuriöse Farben, feine Textur und besondere Haptik aus. Die Faser hat den Bereich Outdoor-Möbel revolutioniert, denn sie ist stark genug, den härtesten Bedingungen zu trotzen und gleichzeitig so biegsam, dass unsere Flechtkünstler kunstvolle Muster aus ihr fertigen können.

Da wir bei DEDON unsere Fasern komplett im eigenen Hause fertigen lassen, können wir gemeinsam mit unseren Designern von Weltruf Fasern mit einzigartigen Farben, Oberflächen und Faserprofilen entwickeln. Jede neu entwickelte Faser wird von unseren Experten auf ihre Beständigkeit gegen UV-Strahlung, Salz- und Chlorwasser sowie extreme Temperaturen geprüft. Das fertige Produkt ist schadstofffrei, umweltfreundlich sowie voll recycelbar, wartungsfrei, leicht zu reinigen und für den Einsatz im Innen- und Außenbereich geeignet.

DEDON EcoCycle Faser - Hergestellt mit Hilfe von Mutter Natur 

DEDON EcoCycle Faser wird zu 90% aus erneuerbaren pflanzlichen Ressourcen gewonnen und ist eine umweltbewusste Alternative zu konventionellen, auf fossilen Brennstoffen basierenden Produkten. Sie bietet die gleiche luxuriöse Optik, Haptik und Witterungsbeständigkeit wie die original DEDON Faser.

Mit EcoCycle Faser beweist DEDON die Machbarkeit eines innovativen Beschaffungsverfahrens für nachwachsende Rohstoffe. DEDON EcoCycle Faser wird aus Polyethylen hergestellt, das aus Zuckerrohr-Ethanol gewonnen wird. Extrudiert in DEDONs eigenen hochmodernen Produktionsanlagen in Norddeutschland, erfüllt die EcoCycle Faser die gleichen außergewöhnlichen Qualitätsstandards und ist durch die gleiche Garantie geschützt wie die original DEDON Faser. Wie diese ist sie am Ende ihres Produktlebenszyklus über bestehende Systeme vollständig recycelbar.



# FIBER OVERVIEW

## AHNDA

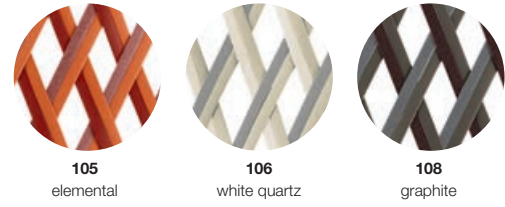

105 elemental  
106 white quartz  
108 graphite

## DALA / DALA LANTERN / DALA PLANTER

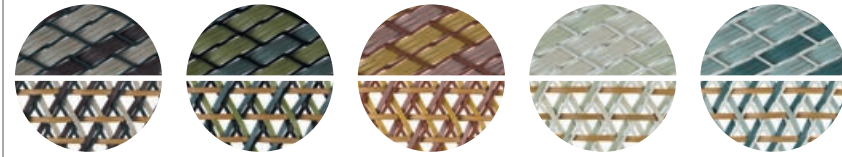

164 rioja  
165 ubud  
166 cuba  
167 ibiza  
168 bahamas

## PORCINI

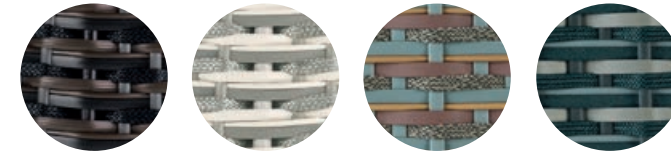

116 marrone  
117 carrara  
147 alba  
148 bosco

## RILLY



157 taupe touch  
158 teal touch  
160 saffron touch

## ROI

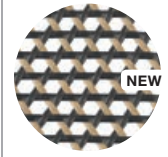

174 tobacco

## KIDA



170 glow touch  
171 ease touch  
172 dusk touch

## LEAF



018 java

## LOUNGE



018 java  
066 bleach

## SEALINE



154 silver beige  
211 titan

## SEASHELL



083 chalk

## SWINGREST



002 natural  
083 chalk

## TANGO

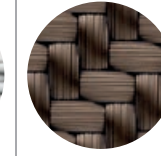

040 bronze

## MBARQ



115 pepper  
141 baltic  
151 chestnut

## MBRACE

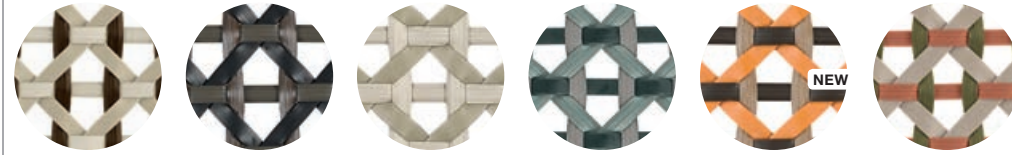

115 pepper  
126 arabica  
140 sea salt  
141 baltic  
142 seville  
151 chestnut

## THE OTHERS



127 forest  
128 cloud  
129 terra  
130 rock

## TIBBO



122 vulcano matte

## MU

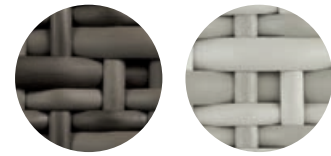

099 vulcano  
111 accona

## NESTREST



002 natural  
083 chalk

## ORBIT / ORBIT XXL

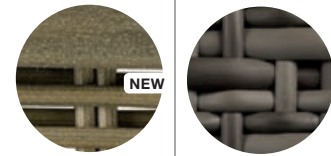

099 vulcano  
730 olive

## PANAMA

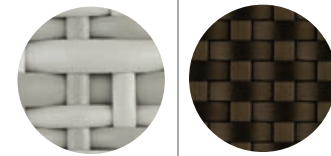

040 bronze

## PAROS



162 silt

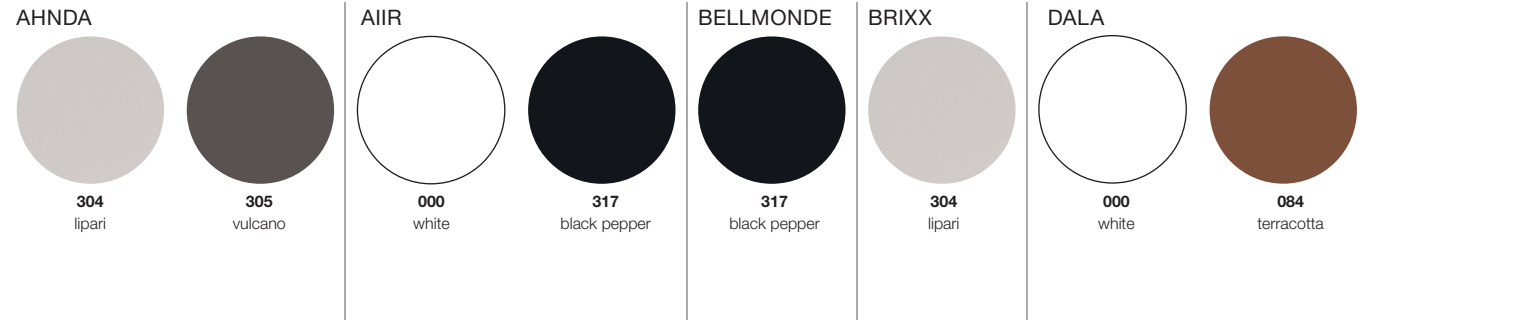
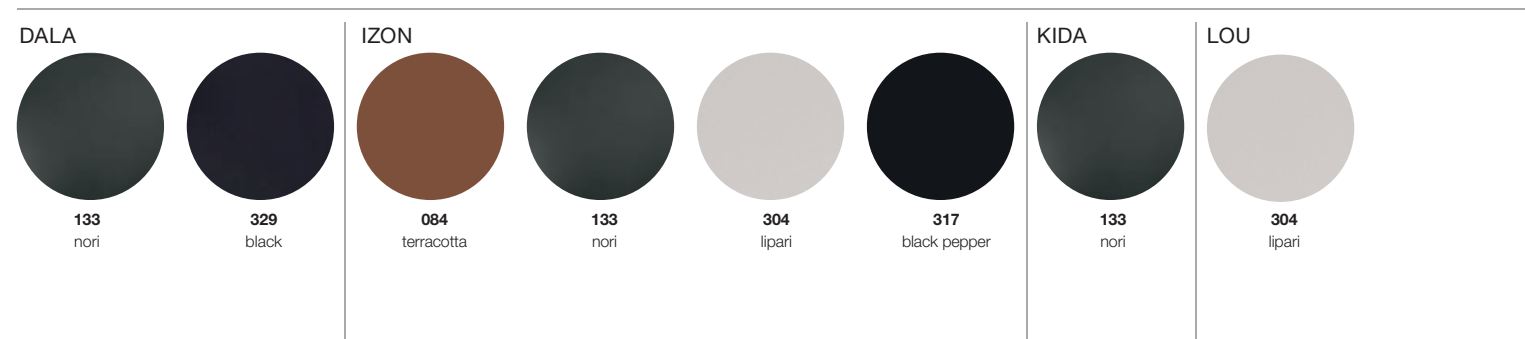
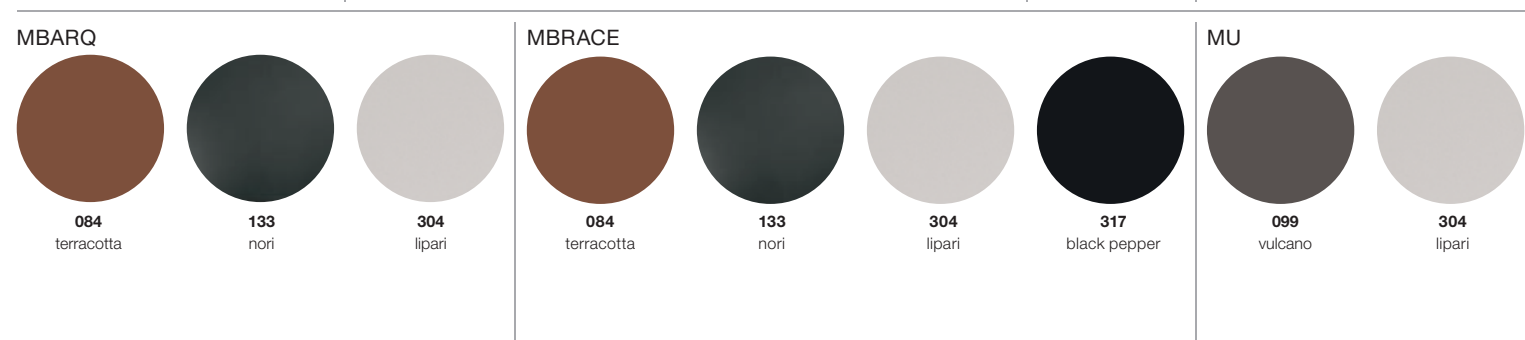

# POWDER COATING OVERVIEW

<b>AHNDA</b>  <p>304 lipari</p> <p>305 vulcano</p> <p>000 white</p> <p>317 black pepper</p> <p>317 black pepper</p> <p>304 lipari</p> <p>000 white</p> <p>084 terracotta</p>	<b>AIIR</b> <p>000 white</p>	<b>BELLMONDE</b> <p>317 black pepper</p>	<b>BRIX</b> <p>304 lipari</p>	<b>DALA</b> <p>000 white</p> <p>084 terracotta</p>	
<b>DALA</b>  <p>133 nori</p> <p>329 black</p> <p>084 terracotta</p> <p>133 nori</p> <p>304 lipari</p> <p>317 black pepper</p> <p>133 nori</p> <p>304 lipari</p>	<b>IZON</b> <p>084 terracotta</p> <p>133 nori</p> <p>304 lipari</p> <p>317 black pepper</p>	<b>KIDA</b> <p>133 nori</p>	<b>LOU</b> <p>304 lipari</p>		
<b>MBARQ</b>  <p>084 terracotta</p> <p>133 nori</p> <p>304 lipari</p> <p>084 terracotta</p> <p>133 nori</p> <p>304 lipari</p> <p>317 black pepper</p> <p>099 vulcano</p> <p>304 lipari</p>	<b>MBRACE</b> <p>084 terracotta</p> <p>133 nori</p> <p>304 lipari</p> <p>317 black pepper</p>	<b>MU</b> <p>099 vulcano</p> <p>304 lipari</p>			
<b>MINI NESTREST</b> <p>304 lipari</p>	<b>NESTREST</b> <p>304 lipari</p> <p>317 black pepper</p>	<b>PAROS</b> <p>317 black pepper</p>	<b>REAV</b> <p>327 white</p> <p>328 anthracite</p>	<b>RILLY</b> <p>317 black pepper</p>	<b>SATELLITE</b> <p>304 lipari</p> <p>317 black pepper</p>
<b>SEALINE</b> <p>304 lipari</p> <p>317 black pepper</p>	<b>SEAX</b> <p>000 white</p> <p>304 lipari</p> <p>317 black pepper</p>	<b>SWINGREST</b> <p>304 lipari</p>	<b>WA</b> <p>304 lipari</p> <p>317 black pepper</p>		





# TABLETOPS

## EN THE FINISHING TOUCHES FOR YOUR TABLE

**From glass to teak, aluminum to HPL, DEDON offers a wide range of tabletop materials. These innovative solutions not only integrate with the design concepts of the various collections but also meet the top-quality standards DEDON insists upon for all of its outdoor furniture.**

- **GLASS**  
The single-layer tempered glass offers increased resistance to temperature changes as well as excellent resistance to bending, impact and shock. To clean a glass tabletop, use a soft cloth, warm water and a gentle cleanser if needed.
- **HIGH PRESSURE LAMINATE (HPL)**  
HPL is a material that is highly resistant to impact, mechanical stress, moisture and steam. To clean a HPL tabletop, use a soft cloth, warm water and a gentle cleanser if needed.
- **POWDER COATED METAL**  
The metal sheets are covered with a highly resistant powder coating, giving the tabletop unbeatable durability and outdoor performance. Clean with a soft cloth and warm water.
- **POLYETHYLENE**  
Polyethylene is an easy-care material that is characterized by both lightness and resistance. Clean with a soft cloth and warm water.

- **NATURAL-FINISH TEAK**  
Consisting of beautiful premium teak sourced from sustainable plantations, the tabletop is rich with natural tannin oils, offering great durability in extreme weather conditions. Clean with warm water, adding natural soap that is gentle on the material.

- **MINERAL COMPOSITE**  
These innovative, long-lasting mineral-composite tabletops are waterproof, extremely hygienic and highly resistant to frost, UV-rays and abrasion. Clean with soft cloth and warm water.

- **CERAMIC**  
The tabletop is made of Monolite Ipergres®, a frost-proof ceramic that is non-absorbing and highly resistant to impacts, scratches and abrasion. Clean with a soft cloth and warm water. Ceramic tabletops are traditionally handcrafted. This may cause variations that make each piece truly unique.

Do not cover in winter months and ensure sufficient air circulation.

**Watch out: Dark tabletops may become very hot when exposed to strong sunlight.**

## DE DER LETZTE SCHLIFF FÜR IHREN TISCH

**Ob Glas, Teak, Aluminium, Mineralkomposit, Keramik oder HPL: DEDON bietet eine große Palette verschiedener Materialien für Tischplatten. Diese Werkstoffe passen nicht nur genau zum jeweiligen Designkonzept der verschiedenen Kollektionen, sie erfüllen auch die höchsten Qualitätsansprüche, die DEDON bei der Verwendung für Gartenmöbel fordert.**

- **GLAS**  
Das Einscheibensicherheitsglas verfügt über eine verbesserte Temperaturwechselbeständigkeit und weist eine sehr gute Biege-, Schlag- und Stoßfestigkeit auf. Zur Reinigung der Tischplatte eignen sich ein weiches Tuch, warmes Wasser und bei Bedarf ein sanftes Reinigungsmittel.
  - **HIGH-PRESSURE-LAMINATE (HPL)**  
HPL ist ein Material, das sich durch hohe Stoßfestigkeit und extreme Widerstandskraft gegen mechanische Einwirkungen, Feuchtigkeit und Dampf auszeichnet. Zur Reinigung der Tischplatte eignen sich ein weiches Tuch, warmes Wasser und bei Bedarf ein sanftes Reinigungsmittel.
  - **PULVERBESCHICHTETES METALL**  
Die Metallplatten sind mit einer hochresistenten Pulverbeschichtung versehen. Diese Tischplatten zeichnen sich durch besondere Haltbarkeit und Wetterfestigkeit aus. Einfach mit einem weichen Tuch und warmem Wasser zu reinigen.
  - **POLYETHYLEN**  
Polyethylen ist ein pflegeleichtes Material, das sich zugleich durch Leichtigkeit und Widerstandsfähigkeit auszeichnet. Einfach mit einem weichen Tuch und warmem Wasser zu reinigen.
- **NATURBELASSENES TEAK**  
Tischplatten aus Premiumteak von nachhaltig bewirtschafteten Plantagen, das reich an natürlichen Tanninen ist, verfügen auch unter extremen Wetterbedingungen über eine äußerst lange Lebensdauer. Reinigen Sie das Holz mit lauwarmem Wasser unter Hinzugabe von materialschonender Naturseife.
  - **MINERALKOMPOSIT**  
Die innovativen, haltbaren Tischplatten aus Mineralkompositwerkstoff sind wasserfest, extrem hygienisch und hochgradig frost-, UV- und abriebresistent. Einfach mit einem weichen Tuch und warmem Wasser zu reinigen.
  - **KERAMIK**  
Die Keramik-Tischplatten bestehen aus Monolite Ipergres®, einem frostsicheren, nicht-absorbierendem Material, das extrem resistent gegen Stöße, Kratzer und Abrieb ist. Einfach mit einem weichen Tuch und warmem Wasser zu reinigen. Keramik-Tischplatten werden in traditioneller Handarbeit gefertigt. Dadurch können Abweichungen entstehen, die jedes Stück zu einem unverwechselbaren Unikat machen.

In den Wintermonaten nicht abdecken und für ausreichend Luftzirkulation sorgen.

**Achtung: Dunkle Tischplatten können sich im Sonnenlicht sehr stark aufheizen.**

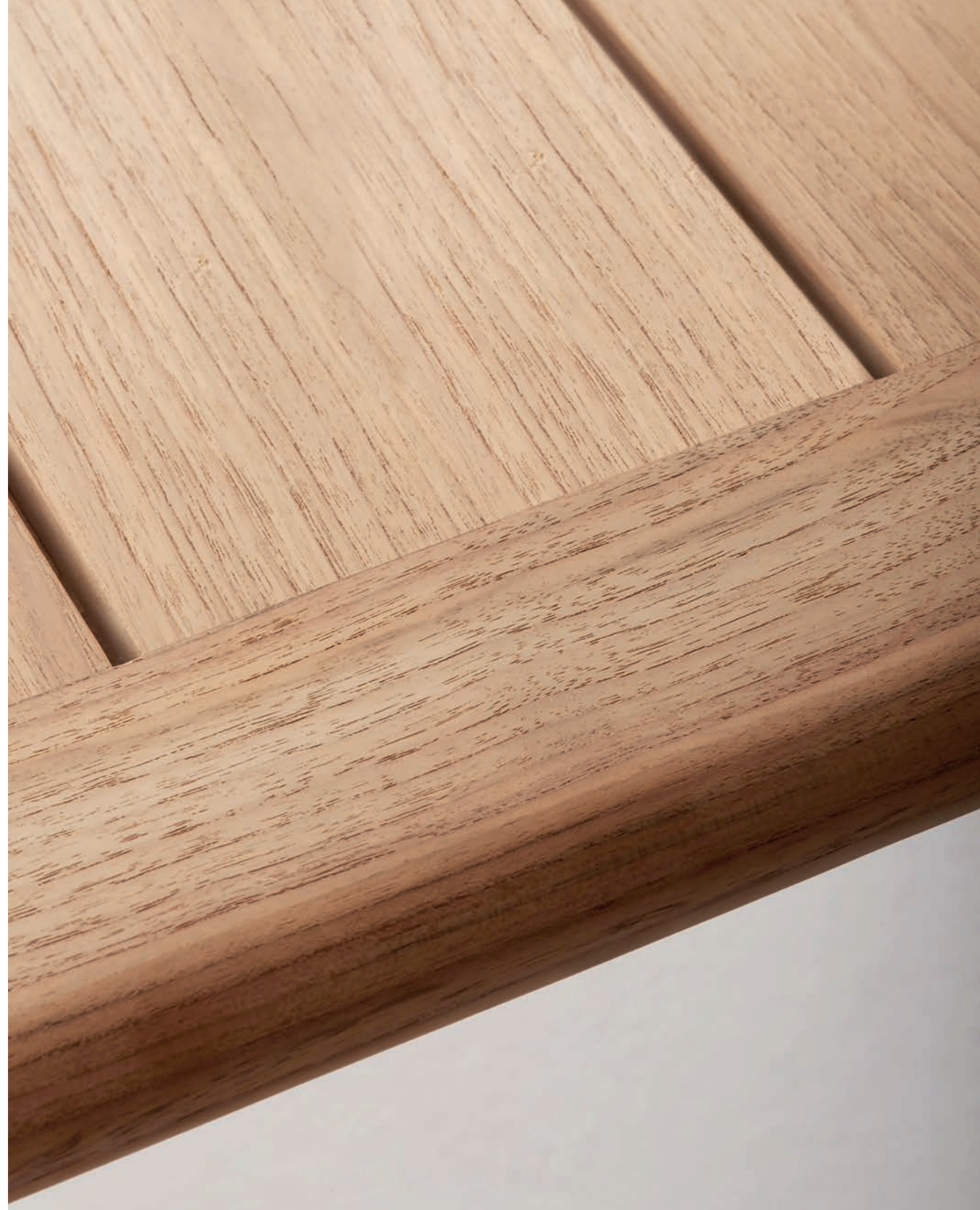



# TABLETOP OVERVIEW

**GLASS**

**AHNDA**  
**105** elemental  
 Bottom: lacquered

**304** lipari  
 Bottom: lacquered

**305** vulcano  
 Bottom: lacquered

**DALA**  
**084** terracotta  
 Top: satinated glass  
 Bottom: lacquered in terracotta

**133** nori  
 Top: satinated glass  
 Bottom: lacquered in nori

**314** stone  
 Top: satinated glass  
 Bottom: lacquered in stone

**IZON**  
**084** terracotta  
 Top: satinated glass  
 Bottom: lacquered in terracotta

**133** nori  
 Top: satinated glass  
 Bottom: lacquered in nori

**LOUNGE**  
**000** clear glass

**MU**  
**304** lipari glass  
 Bottom: lacquered in lipari

**305** vulcano glass  
 Bottom: lacquered in vulcano

**PANAMA**  
**000** satinated glass  
 Bottom: satinated PANAMA dining table, bar table

**000** clear glass  
 PANAMA side table

**TANGO**  
**000** clear glass

**HPL**

**AIIR**  
**001** white

**306** lipari 2.0

**317** black pepper

**BELLMONDE**  
**317** black pepper

**IZON**  
**306** lipari 2.0

**317** black pepper

**MU**  
**306** lipari 2.0

**317** black pepper

**SATELLITE**  
**306** lipari 2.0

**317** black pepper

**WA**  
**306** lipari 2.0

**317** black pepper

**CERAMIC**

**MBRACE**  
**300** chalk

**308** taupe

**341** black

**PORCINI**  
**123** terra

**133** nori

**301** black

**308** taupe

**BABYLON**  
**300** chalk

**308** taupe

**MINERAL COMPOSITE**

**BELLMONDE**  
**203** ebony

**IZON**  
**343** talc

**344** lava

**SEAX**  
**203** ebony

**204** white

**343** talc

**SEALINE**  
**318** white marmi

**319** gray stone

**TEAK**

**LOU**  
**205** teak

**MBRACE**  
**205** teak

**SEALINE**  
**205** teak

**SEAX**  
**205** teak

**TIBBO**  
**205** teak

**WA**  
**205** teak

**POLYETHYLENE**

**BABYLON**  
**off white**

**POWDER COATED METAL**

**BRIXX**  
**304** lipari

# TEAK

## EN THE BEAUTY OF TEAK

Teak is one of the world's most valuable timber resources. Furniture made from beautiful premium teak, sourced from sustainable plantations, is rich in natural tannins and is able to withstand even extreme weather conditions over an exceptionally long lifetime. The wood is resistant to rain, strong sunlight, freezing conditions, and fluctuating temperatures. These qualities make it particularly well-suited to long-term outdoor use.

DEDON teak furniture does not require any special maintenance apart from periodic cleaning. When exposed to natural weather conditions, teak's golden color changes to a soft silver-gray. As this is a natural process, the silver-gray color may appear irregularly, especially at first.

To retain the wood's original, golden hue, clean it, using the DEDON cleaning agent once or twice a year and apply DEDON teak oil at least twice a year. To remove any rough grain and restore the wood to its smooth finish, lightly sand the surface from time to time.

## DE DIE SCHÖNHEIT VON TEAK

Teakholz gehört zu den wertvollsten Nutzhölzern der Welt. Möbel aus diesem schönen Premiumteak aus nachhaltig bewirtschafteten Plantagen, das reich an natürlichen Tanninen ist, verfügen auch unter extremen Wetterbedingungen über eine äußerst lange Lebensdauer. Das Holz widersteht Nässe, extremer Sonneneinstrahlung und Kälte sowie Temperaturschwankungen. Es ist daher zum Dauereinsatz im Freien besonders geeignet.

DEDON Teakmöbel bedürfen neben einer gelegentlichen Reinigung keiner besonderen Pflege. Setzt man Teak auf natürliche Weise dem Wetter aus, verändert sich seine goldene Farbe und wird zu einem weichen Silbergrau. Da es sich hierbei um einen natürlichen Alterungsprozess handelt, kann das Silbergrau besonders anfangs noch etwas ungleichmäßig erscheinen.

Wünschen Sie einen Erhalt des goldenen Farbtons, reinigen Sie das Holz ein- oder zweimal im Jahr mit DEDON-Reinigungsmittel und streichen Sie das Teak mindestens alle 6 Monate mit DEDON Teak-Öl ein. Teakmöbel können von Zeit zu Zeit leicht abgeschliffen werden, um raue Maserungen zu entfernen und die Oberfläche wieder zu glätten.

Allow your teak furniture with cushions to dry before using covers. To prevent mold growth, DEDON recommends not to use covers for tables with teak tabletops.

Cushions that are in contact with new teak can occasionally show signs of teak staining. This is caused when the natural pigments and oils within the new teak bleed out over time, leaving a red-brown stain on the cushion fabric. To remove the teak stains, wash the cushion covers at a lukewarm temperature (30°C) with a mild soap.

Teak bleeding may leave stains on the ground around the furniture as well. Any damage caused by teak bleeding is not covered by DEDON warranty.

Stellen Sie sicher, dass die Teakmöbel mit Kissen vollständig trocken sind, bevor Sie sie abdecken. Wir raten Ihnen Tische mit Teakoberfläche nicht mit Hussen abzudecken, um Schimmelbildung auf der Tischplatte vorzubeugen.

Kissen, die mit neuem Teakholz in Kontakt kommen, können gelegentlich Anzeichen von Flecken aufweisen. Dies wird verursacht, wenn die Pigmente und Öle im neuen Teakholz mit der Zeit ausbluten und einen rotbraunen Fleck auf dem Kissenstoff hinterlassen. Um diese Teakholz-Flecken zu entfernen, waschen Sie die Kissenbezüge bei niedriger Temperatur (30°C) mit lauwarmem Wasser und einer milden Seife.

Ausblutendes Teakholz kann ebenfalls Flecken auf dem Boden rund um die Möbel hinterlassen. Schäden, die durch Teakholzbluten entstehen, sind nicht durch die DEDON Garantie abgedeckt.



NATURAL-FINISH TEAK  
Naturbelassenes Teakholz



WEATHERED TEAK  
Verwittertes Teak

# MAINTENANCE PRODUCTS

TEAK CLEANER  
Teak-Reiniger

Volume: 1.000 ml  
Inhalt: 1.000 ml



TEAK OIL  
Teak-Öl

Volume: 1.000 ml  
Inhalt: 1.000 ml



6600000759

**EN** The DEDON teak cleaner is easy to use and solvent-free. It has been specifically developed to remove atmospheric dirt, algae, gray discoloration, grease and oil from ridges and difficult-to-reach gaps and grooves.

DEDON teak-oil is easy to use, solvent-free and highly water-repellent. It gives a satin finish and contains pigments that effectively block the UV rays that turn your wooden DEDON furniture gray over time. It also protects against rain and prevents the build-up of algae and moss. Applying the oil provides long-term weathering protection for your teak furniture.

6640000055

**DE** Der DEDON Teak-Reiniger ist einfach in der Anwendung und lösemittelfrei. Er wurde speziell zur Reinigung von atmosphärischen Verschmutzungen, Algenbefall, Vergrauungen, Fett und Öl auch aus Riffelungen und schwer zu erreichenden Ritzen und Füllen entwickelt.

Das DEDON Teak-Öl ist einfach in der Anwendung, lösemittelfrei und stark wasserabweisend. Es ist seidenmatt und enthält Pigmente, die UV-Strahlen wirksam blockieren und so das Holz Ihrer DEDON Möbel vor Vergrauung und Feuchtigkeit schützen. Daneben bewahrt es die Oberfläche vor Algen und Moosbildung. Somit stellt es einen dauerhaften Wetterschutz für Ihre Teakmöbel dar.

# PROTECTIVE COVERS

## EN DEDON PROTECTIVE COVERS – HANDLING AND CARE

DEDON furniture covers are made of Weathermax®, a heavy-duty, 100%-solution-dyed polyester fabric. Weathermax® is water-repellent and UV-resistant, with outstanding breathability and durability. Because of the superior breathability of the material, DEDON covers minimize dampness, heat build-up and condensation, helping to prevent mold and mildew from forming on your furniture.

Tailored to fit perfectly over their corresponding products, DEDON covers feature zippers for easy draping as well as elastic straps and loops (product-specific) for securing them in windy conditions. Clean covers with a soft cloth and warm water. If needed, use a gentle upholstery cleaner. Do not bleach or iron. Make sure that both the furniture and the cushions are completely dry before applying DEDON covers.

Take care to prevent puddles of water from forming on the cover's surface.

For longer periods, e.g. during wintertime, we recommend storing your cushions in a dry place indoors.

## DE DEDON HUSSEN – HANDHABUNG UND PFLEGE

Die DEDON-Hussen bestehen aus dem Stoff Weathermax®, einem zu 100% in Masse gefärbten, extrem strapazierfähigen Polyester. Weathermax® ist sowohl resistent gegen UV-Strahlung als auch wasserabweisend, luftdurchlässig und langlebig. Die Luftdurchlässigkeit des Materials ist zur Reduzierung von Feuchtigkeit, Wärmeentwicklung und Kondensation sehr wichtig. Das wiederum beugt Schimmelbildung auf oder in den Möbeln vor.

Die Hussen wurden den Maßen Ihres Möbelstückes genau angepasst. Sie sind – je nach Produkt – mit Reißverschlüssen, elastischen Nähten und Schlaufen ausgestattet, damit sie einfach über dem Möbel platziert und bei Wind festgezurt werden können. Achten Sie darauf, dass sich auf der Hussenoberfläche keine Wasserablagerungen bilden. Reinigen Sie die Hussen mit einem weichen Tuch und warmem Wasser. Wenn nötig, verwenden Sie einen schonenden Polsterreiniger. Nicht bleichen, nicht bügeln.

Stellen Sie sicher, dass sowohl die Möbel als auch die Kissen vollständig trocken sind, bevor Sie sie abdecken. Für die dauerhafte Lagerung (beispielsweise während der Wintermonate) raten wir Ihnen die Kissen im Innenraum aufzubewahren.

MODULAR LOUNGING  
Modulares Lounging



SEALINE EXTENDED DAYBED LEFT  
SEALINE verlängertes Daybed links



RILLY COCOON CHAIR  
RILLY Cocoon chair



ORBIT LOVESEAT  
ORBIT Sofainset



MBRACE LOUNGING  
MBRACE Lounging



PORCINI SIDE TABLE  
PORCINI Beistelltisch



SEAX ARMCHAIR  
SEAX Armlehnstuhl



KIDA HANGING LOUNGE CHAIR  
KIDA Hängender Sessel



TABLES  
Tische



TABLES WITH TEAK BASE  
Tische mit Teak Untergestell









# DECO CUSHIONS

**DECO CUSHIONS**  
Dekokissen

40 15¾"  
  
**40 15¾"**  
 COM 0,48 M  
**95050081**

50 19¾"  
  
**50 19¾"**  
 COM 0,58 M  
**95050082**

60 23½"  
  
**60 23½"**  
 COM 0,68 M  
**95050084**

55 21¾"  
  
**55 21¾"**  
 COM 0,70 M  
**95092084**

Ø 40 Ø 15¾"  
  
 COM 0,48 M  
**95050088**

30 11¾"  
  
**45 17¾"**  
 COM 0,71 M  
**95050089**

40 15¾"  
  
**50 19¾"**  
 COM 0,58 M  
**95050085**

40 15¾"  
  
**60 23½"**  
 COM 0,68 M  
**95050083**

25 9¾"  
  
**62 24½"**  
 COM 0,33 M  
**95050090**

70 27½"  
  
**70 27½"**  
 COM 0,85 M  
**95050086**

Ø 55 Ø 21¾"  
  
 COM 0,71 M  
**95050091**

**DEDON fabrics per meter**  
DEDON Stoffe Meterware

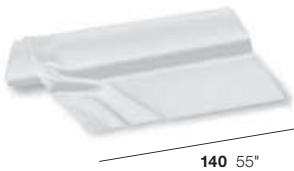

140 55"

**95060092**



# CUSHIONS & FABRICS

## EN CUSHIONS YOU CAN LEAVE OUTDOORS

DEDON relies on some of the world's most advanced textile technologies to create cushions you can leave outside. Our high-quality materials are UV-resistant and specially treated to be splash-resistant, all with no loss of comfort. The foam cores, created exclusively for DEDON, and synthetic fiber padding are surrounded by a water-repellent, breathable, spun-bonded wrap. After a rain shower, allow your cushions to dry so as to protect them from mold stains. We recommend storing your cushions for the winter or when not in use for long periods, and using DEDON covers to keep them at their best. Before storing, make sure the cushions are completely dry. Our materials meet the highest standards of quality for outdoor usage. All fabrics are easy to maintain.

### DRY+ CUSHION CONSTRUCTION

Dry+ cushions offer enhanced rain protection. Cushion cores are wrapped in an interlayer with a very high water-repellent rating of 10,000 mm. The special construction of the cushions ensures a very fast drying process. All fabrics are specially treated to be stain- and water-repellent. Dry+ cushions are available for any collections accompanied by this icon:



## DE KISSEN, DIE DRAUSSEN BLEIBEN KÖNNEN

DEDON setzt die weltweit modernsten Materialien und Herstellungsverfahren ein, damit Ihre Kissen auch mal draußen bleiben können. Dank einer speziellen Ausrüstung unserer hochwertigen Stoffe, sind diese spritzwassergeschützt und UV-beständig, ohne sich deshalb weniger komfortabel anzufühlen. Der speziell für DEDON hergestellte Schaumstoffkern und die Kunstfaserpolsterung werden durch einen wasserabweisenden und gleichzeitig atmungsaktiven Spinnvliesstoff umhüllt. Lassen Sie Ihre Kissen nach einem Regenschauer trocknen, um sie vor Stockflecken zu schützen. Lagern Sie Ihre Kissen im Winter oder wenn Sie sie über längere Zeit nicht nutzen im Innenbereich. Am schönsten bleiben die Kissen, wenn Sie sie mit DEDON-Hussen abdecken. Stellen Sie vor dem Verstauen und Abdecken sicher, dass die Kissen vollständig trocken sind. Unsere Materialien sind pflegeleicht und entsprechen den höchsten Qualitätsstandards für die Nutzung im Freien.

### DRY+ KISSENKONSTRUKTION

Dry+ Kissen bieten durch eine stark wasserabweisende innere Hülle mit einer Wassersäule von 10.000 mm einen erweiterten Wetterschutz. Die spezielle Konstruktion der Kissen sorgt dabei für eine noch schnellere Trocknung. Der Stoff ist so behandelt, dass er schmutz- und wasserabweisend ist. Die Dry+ Kissenkonstruktion ist erhältlich für alle Kissen, die mit folgendem Icon gekennzeichnet sind:



## FABRIC STYLES TO PLAY WITH

Each of the fabric styles in this catalog has a distinctive weaving structure that gives it a look and feel all its own. While any one of these fabrics is an ideal covering for cushions large or small, it's the opportunity to combine them that makes the DEDON collection so special. Play with textures. Mix the summery lightness of NATURA with the robustness of ATRIUM. Create subtle differences of shade by working with multiple fabric structures in the same color. The flexibility and creativity long associated with the finest indoor fabrics can now be enjoyed under the open skies.

## STOFFVARIATIONEN BIETEN ABWECHSLUNG

Jede der Stoffvarianten in diesem Katalog hat ihre eigene unvergleichliche Webstruktur und damit einen ganz einzigartigen Look & Feel. Während sich jeder unserer Stoffe perfekt als Bezug für unsere Kissen eignet, egal ob klein oder groß, sind es insbesondere die vielfältigen Kombinationsmöglichkeiten der Stoffe untereinander, die die DEDON-Stoffkollektion so attraktiv machen. Spielen Sie mit den Texturen, etwa indem Sie die sommerliche Frische von NATURA mit der Robustheit von ATRIUM kombinieren. Schaffen Sie subtile Farbnuancen, indem Sie mit unterschiedlichen Strukturen in der gleichen Farbwelt arbeiten. Freuen Sie sich, dass Sie unter freiem Himmel ebenso abwechslungsreich und kreativ sein können, wie Sie es von den feinsten Indoor-Stoffen gewohnt sind.

## DRY+ CUSHION CONSTRUCTION

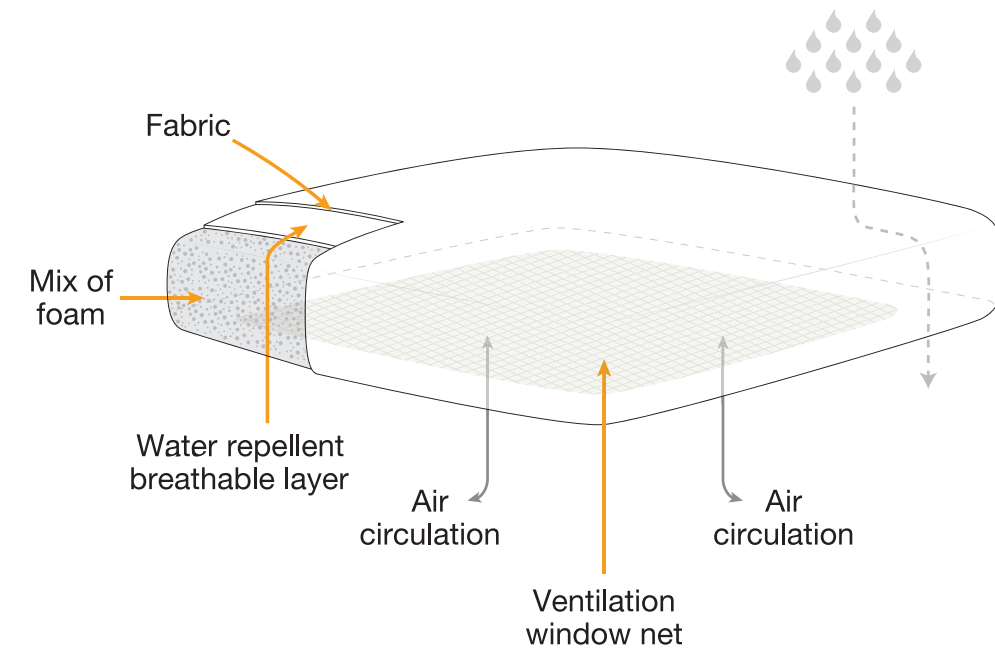



# FABRICS OVERVIEW

## CATEGORY A

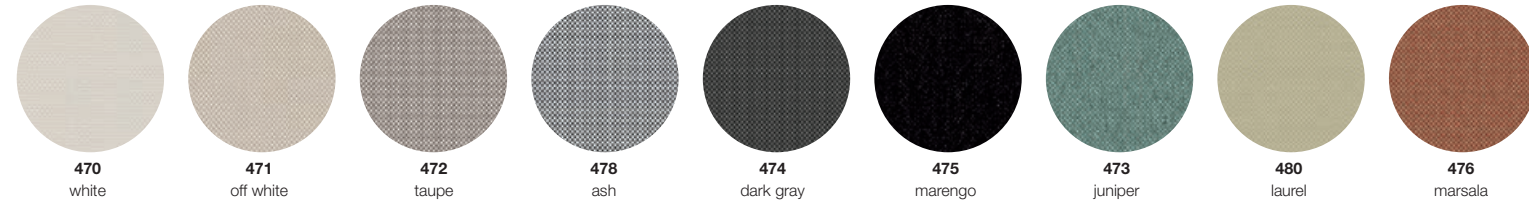

NATURA ACRYLIC

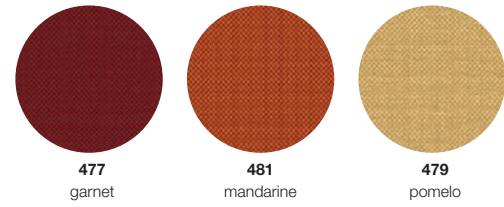

**NATURA A** Light, soft, summery fabric in a strié weave, NATURA has a cotton-like touch and carries color beautifully.

## CATEGORY B

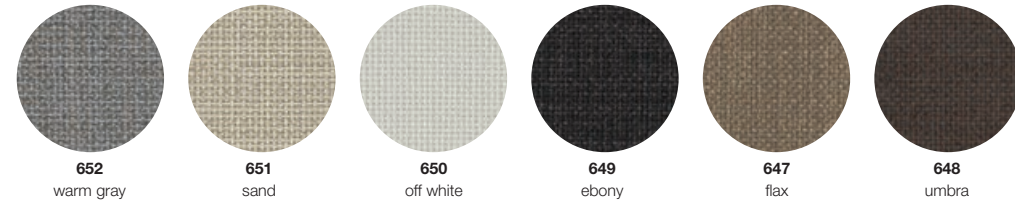

LINEN ACRYLIC

**LINEN** is an exceptionally comfortable fabric with a natural look and feel and a contemporary color palette.

## CATEGORY B

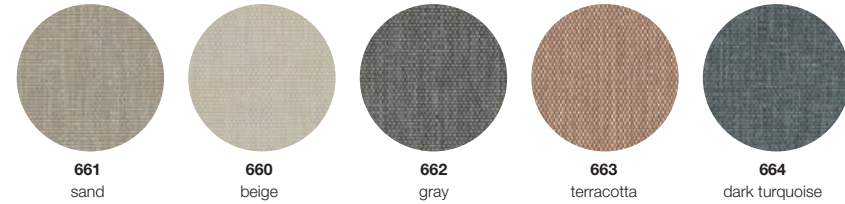

TWIST POLYPROPYLENE

**TWIST** Woven from fine twisted yarn, TWIST is a fresh, cool fabric with depth, structure and a lively color effect.

## CATEGORY B

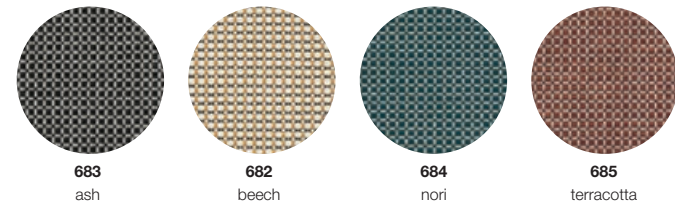

MAR POLYPROPYLENE

**MAR** Made of a blend of colored yarns in a basket weave, MAR is available in four colors, each one rich and complex.

## CATEGORY B

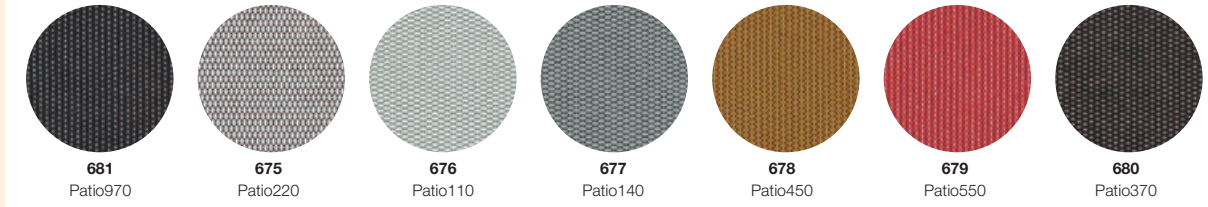

PATIO KVADRAT® TREVIRA CS

**PATIO BY KVADRAT** With its subtle woven structure, PATIO by Kvadrat® stands out for its softness and exceptional color vibrancy.

## CATEGORY C

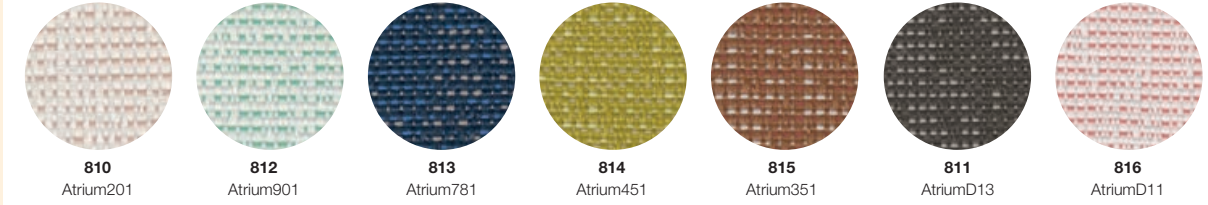

ATRIUM KVADRAT® TREVIRACS

**ATRIUM BY KVADRAT** With its subtle woven structure, ATRIUM by Kvadrat® stands out for its softness and exceptional color vibrancy.

## CATEGORY C

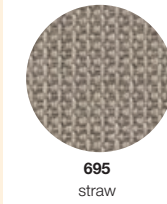

PUNO ACRYLIC

**PUNO** This thick and pleasing fabric gets its natural appearance through the use of 50-percent recycled post-industrial fibers, which convey both depth and richness of tone.

## CATEGORY C

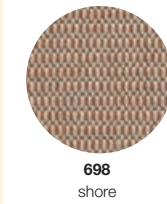

DUNE ACRYLIC

**DUNE** Soft and inviting, this fabric's chunky yarns are spun with 50-percent recycled post-industrial fibers in a mix of colors, ensuring each yarn is unique.

## CATEGORY C

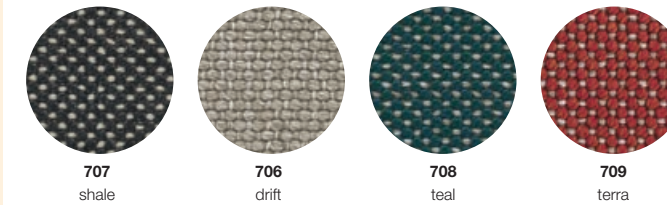

GLAN POLYPROPYLENE

**GLAN** A thick and hearty fabric, available in four colors, GLAN is distinguished by its inviting 3D woven structure.



FABRIC CARE

# QUALITY

## EN BEST REASONS FOR CHOOSING DEDON

### PRODUCED IN OUR OWN FACILITIES

The manufacturing of both DEDON Fiber in Germany and DEDON furniture in the Philippines take place in our own production facilities. This is unique in the outdoor furniture industry and ensures that fine craftsmanship is combined with innovative technology. DEDON's master weavers in the Philippines use ultra-strong fibers from our own DEDON production. For our contract partners, in-house production also means special opportunities for customization.

### WORLD'S BEST FIBER

No matter if it's desert wind, salt water or frost, DEDON Fiber is tested against all weather conditions and for 10 years' UV resistance. Produced in Germany by our team of specialists, it is unrivaled for strength, color fastness and longevity. And because DEDON Fiber is developed entirely in-house, we are able to work with designers to create innovative solutions, including unique colors, textures and profiles.

### THE RIGHT MATERIAL FOR EVERY SETTING

Specialists in outdoor living spaces of all kinds, DEDON selects the right material for every setting, from covered terraces to exposed poolsides to sandy beaches to wild nature. That's why, in addition to the world's best fiber, we work with highest-quality teak, aluminum, woven textiles, ceramics and upholstery, all manufactured with passion for excellence.

## DE DIE BESTEN GRÜNDE FÜR DEDON

### EIGENE PRODUKTION

Sowohl die Herstellung der DEDON Faser in Deutschland als auch die Möbelproduktion auf den Philippinen findet in eigenen Produktionsstätten statt – dies ist einzigartig in der Outdoor-Möbel-Branche. Handwerkskunst verbindet sich mit innovativer Technik – die DEDON Meisterflechter auf den Philippinen verwenden hochbelastbare Fasern aus der eigenen DEDON Produktion. Für unsere Objektpartner schafft die Produktion im eigenen Werk auch besondere Möglichkeiten für die Entwicklung individueller Farb- und Flechtvariationen.

### DIE WELTBESTE FASER

Egal ob Wüstenwind, Salzwasser oder Frost – die DEDON-Faser ist gegen alle Witterungen und auf zehn Jahre UV-Beständigkeit getestet. Die in Deutschland von unserem Spezialistenteam hergestellte Faser ist in Sachen Festigkeit, Farbbeständigkeit und Langlebigkeit konkurrenzlos. Und weil wir bei DEDON unsere Fasern komplett im eigenen Hause entwickeln lassen, können wir in Zusammenarbeit mit unseren Designern innovative Lösungen entwickeln – einschließlich neuer Farben, Oberflächen und Faserprofile.

### DIE RICHTIGEN MATERIALIEN FÜR JEDE UMGEBUNG

Als Spezialisten für alle Bereiche des Outdoor Living setzen wir bei DEDON auf die richtigen Materialien für jedes Umfeld, von der schattigen Terrasse bis zur prallen Sonne eines Poolbereichs, vom feinen Sandstrand bis zur wilden Naturlandschaft. Deshalb verwenden wir nicht nur die weltbeste Faser, sondern setzen auch ausschließlich Teakholz, Aluminium, Webtextilien, keramische Materialien und Polsterungen von höchster Qualität ein, die mit leidenschaftlichem Qualitätswillen gefertigt wurden.

### SUSTAINABILITY

It is DEDON's corporate philosophy to create furniture and accessories of such high quality that they need never be thrown away. Produced in our environmentally-sound facilities in Northern Germany, DEDON Fiber is 100% recyclable and free from pollutants and heavy metals. In addition DEDON incorporates recycled materials into our products whenever feasible.

### DESIGN

DEDON collaborates with the world's top designers, from famous names to rising stars, on collections that consistently win the most prestigious design awards. Our in-house research and development department is able to work closely with each designer on solutions and innovations that make all the difference in terms of quality, function and style.

### GLOBAL REACH

Distributed in more than 80 countries, with showrooms and sales office around the world, DEDON is a global company with a global mindset. We travel the world -- with furniture and our team -- as part of our ongoing adventure, and no island or secret hideaway is too remote for us. Wherever our contract partners have projects to undertake, DEDON is available and ready to help.

### NACHHALTIGKEIT

Es ist Teil der Unternehmensphilosophie von DEDON, dass wir Möbel und Accessoires von so hoher Qualität fertigen, dass sie ein Leben lang halten. Die DEDON-Faser, die in unserer umweltverträglich arbeitenden Produktionsstätte in Norddeutschland hergestellt wird, ist zu 100% recycelbar und frei von Schadstoffen und Schwermetallen. Darüber hinaus setzen wir bei der Herstellung unserer Produkte so oft wie möglich recycelte Materialien ein.

### DESIGN

DEDON arbeitet mit Top-Designern aus aller Welt zusammen, vom Designer mit großem Namen bis zum aufstrebenden Jungdesigner. So entstehen Kollektionen, die immer wieder die prestigeträchtigsten Designpreise gewinnen. Dabei arbeitet unsere hauseigene Entwicklungsabteilung eng mit den Designern zusammen, um so Lösungen und Innovationen zu schaffen, die sich in Qualität, Funktionalität und Stil entschieden absetzen.

### GLOBALE VERFÜGBARKEIT

Mit seinem in über 80 Ländern tätigen Vertrieb sowie Showrooms in aller Welt ist DEDON ein globale agierendes Unternehmen. Unsere Abenteuer führen uns – samt Möbeln und Team – kreuz und quer über den Planeten. Dabei ist uns keine Insel und kein versteckter Winkel zu entlegen. Wo auch immer unsere Objektpartner ihre Projekte abwickeln, ist DEDON zur Stelle und unterstützt sie gern.

# IMPRINT

**Project Management & Execution** Jan Janecki; **Creative Direction** Chloé Sos; **Art Direction** Clas Lenze; **Production** Cornelia Drews; **Copy & Master Data Management** Sybille Korn; **Copy** Luisa Homann; **3D-Rendering** sooil GmbH, deluma; **Digital Imaging** Hanse Repro; **Print** Beisner Druck GmbH & Co. KG



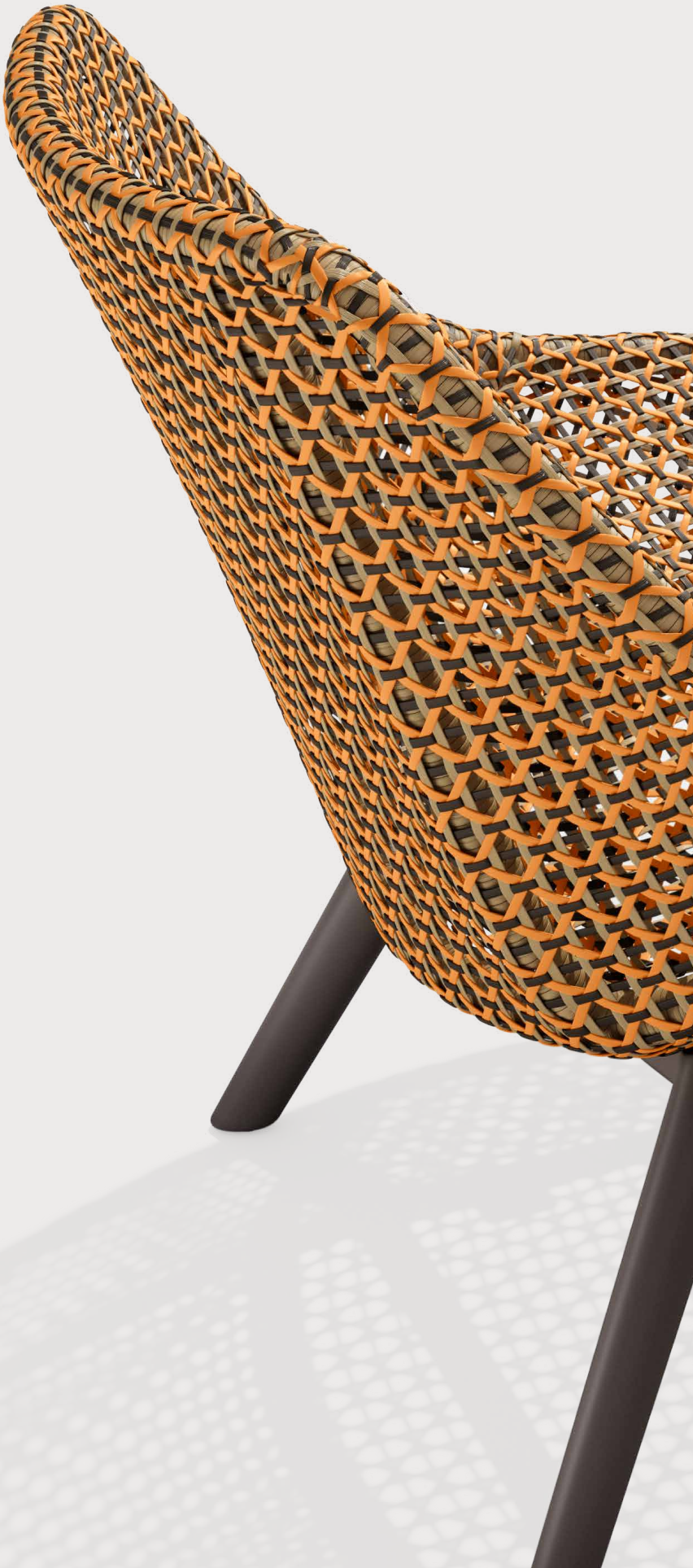

**DEDON GmbH**

Zeppelinstraße 22  
21337 Lüneburg / Germany  
Tel. +49 4131 / 22 44 70  
Fax +49 4131 / 22 44 7 630  
info@dedon.de

**DEDON Inc.**

657-C Brigham Road  
Greensboro, NC 27409  
877-693-3366  
office@dedon.us

[www.dedon.de](http://www.dedon.de)